

TC52

Touch Computer

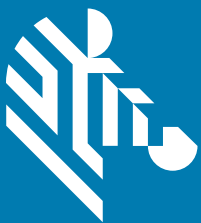

User Guide for Android™ 8.1.0 Oreo



ZEBRA

Copyright

© 2018 ZIH Corp. and/or its affiliates. All rights reserved. ZEBRA and the stylized Zebra head are trademarks of ZIH Corp., registered in many jurisdictions worldwide. Google, Android, Google Play and other marks are trademarks of Google LLC; Oreo is a trademark of Mondelez International, Inc. group. All other trademarks are the property of their respective owners.

COPYRIGHTS & TRADEMARKS: For complete copyright and trademark information, go to www.zebra.com/copyright.

WARRANTY: For complete warranty information, go to www.zebra.com/warranty.

END USER LICENSE AGREEMENT: For complete EULA information, go to www.zebra.com/eula.

Terms of Use

- Proprietary Statement

This manual contains proprietary information of Zebra Technologies Corporation and its subsidiaries (“Zebra Technologies”). It is intended solely for the information and use of parties operating and maintaining the equipment described herein. Such proprietary information may not be used, reproduced, or disclosed to any other parties for any other purpose without the express, written permission of Zebra Technologies.

- Product Improvements

Continuous improvement of products is a policy of Zebra Technologies. All specifications and designs are subject to change without notice.

- Liability Disclaimer

Zebra Technologies takes steps to ensure that its published Engineering specifications and manuals are correct; however, errors do occur. Zebra Technologies reserves the right to correct any such errors and disclaims liability resulting therefrom.

- Limitation of Liability

In no event shall Zebra Technologies or anyone else involved in the creation, production, or delivery of the accompanying product (including hardware and software) be liable for any damages whatsoever (including, without limitation, consequential damages including loss of business profits, business interruption, or loss of business information) arising out of the use of, the results of use of, or inability to use such product, even if Zebra Technologies has been advised of the possibility of such damages. Some jurisdictions do not allow the exclusion or limitation of incidental or consequential damages, so the above limitation or exclusion may not apply to you.

Revision History

Changes to the original guide are listed below:

Change	Date	Description
-01 Rev A	9/2018	Initial release.

Table of Contents

Copyright	2
Terms of Use	2
Revision History	2
About This Guide	12
Introduction	12
Documentation Set	12
Configurations	12
Software Versions	12
Chapter Descriptions	13
Notational Conventions	13
Related Documents	14
Service Information	14
Provide Documentation Feedback	15
Getting Started	16
Introduction	16
Unpacking	16
Features	17
Setup	19
Installing a microSD Card	19
Installing the Battery	21
Charging the Battery	21
Charging Indicators	22
Google Account Setup	22
Zebra Visibility Services	23
Replacing the Battery	23
Replacing the microSD Card	24
Accessing Device Settings	25
Battery Management	26

Table of Contents

Monitoring Battery Usage	26
Low Battery Notification	27
Battery Optimization	27
Setting the Date and Time	27
Display Settings	28
Setting the Screen Brightness	28
Setting Screen Rotation	28
Setting Home Screen Rotation	29
Setting Screen Timeout	29
Setting Font Size	30
Ambient Display	31
Touch Panel Mode	31
Setting Notification LED	32
General Sound Setting	32
Wake-Up Sources	33
Using the Device	35
Introduction	35
Google Mobile Services	35
Home Screen	35
Status Bar	37
Status Icons	37
Notification Icons	38
Managing Notifications	38
Setting App Notifications	39
Viewing Notification Settings for All Apps	40
Controlling Lock Screen Notifications	40
Quick Access Panel	40
Editing Icons on Quick Settings	41
App Shortcuts and Widgets	42
Adding an App Shortcut to the Home Screen	42
Adding a Widget to the Home Screen	42
Moving Items on the Home Screen	43
Removing an App Shortcut or Widget from the Home Screen	43
Folders	43
Creating a Folder	43
Naming Folders	43
Removing a Folder	44
Home Screen Wallpaper	44
Using the Touchscreen	44
Keyboards	45
Editing Text	45
Entering Numbers, Symbols, and Special Characters	45

Table of Contents

Keyboard Configuration	45
Enabling Keyboards	45
Switching Between Keyboards	45
Do Not Disturb Feature	45
Limit Sounds and Vibrations	46
Total Silence	46
Alarms Only	46
Automatically Block Sounds and Vibrations	46
Silence Sounds During Certain Times	47
Silence Sounds During Events and Meetings	47
Turn Sounds Back On	47
Override Do Not Disturb for Specific Apps	48
Apps	48
Accessing Apps	51
Switching Between Recent Apps	52
Un-Locking the Screen	53
Smart Lock	55
Resetting the Device	56
Performing a Soft Reset	56
Performing a Hard Reset	57
Suspend Mode	57
Transferring Files with a Host Computer via USB	57
Transferring Files	57
Transferring Photos	58
Disconnect from the Host Computer	58
Applications	60
Introduction	60
ActiveEdge Touch Zone	60
Configuring ActiveEdge	60
Selecting Apps for a Drawer	61
Using ActiveEdge	64
Battery Manager	66
Contacts	69
Adding a Contact	69
Editing Contacts	69
Deleting Contacts	69
Camera	70
Taking Photos	70
Taking a Panoramic Photo	71
Recording Videos	71

Table of Contents

Photo Settings	72
Front Camera	72
Rear Camera	73
Video Settings	74
Front Camera	74
Rear Camera	74
Diagnostic Tool	76
Settings	79
Battery Test Information	79
GPS Test Information	80
System Test Information	80
WLAN Test Information	80
WWAN Test Information	80
Bluetooth Test Information	80
Files	81
Gallery	82
Working with Albums	84
Sharing an Album	84
Getting Album Information	84
Deleting an Album	85
Working with Photos	85
Viewing and Browsing Photos	85
Cropping a Photo	86
Setting a Photo as a Contact Icon	86
Sharing a Photo	87
Deleting a Photo	87
Working with Videos	87
Watching Videos	87
Sharing a Video	87
Deleting a Video	88
Photos	89
Working with Albums	91
Sharing an Album	91
Deleting an Album	91
Working with Photos	92
Viewing and Browsing Photos	92
Cropping a Photo	93
Setting a Photo as a Contact Icon	93
Sharing a Photo	94
Deleting a Photo	94
Working with Videos	94
Watching a Video	94
Sharing a Video	94
Deleting a Video	94
Device Central	95

Table of Contents

Device Central Tabs	95
Paging an RS6000 Ring Scanner	96
DataWedge Demonstration	98
Scanner Selection	99
PTT Express Voice Client	100
PTT Audible Indicators	100
PTT Notification Icons	100
Enabling PTT Communication	101
Selecting a Talk Group	101
PTT Communication	101
Creating a Group Call	102
Responding with a Private Response	102
Disabling PTT Communication	102
RxLogger	103
RxLogger Utility	104
SimulScan Demo	105
Printing the Sample Forms	105
Using the Postal, Transportation and Logistics Example	106
Using the Manufacturing Example	108
Settings	109
Advanced Settings	110
Creating a Demo Customization	111
Default Templates	112
Sound Recorder	113
Data Capture.....	114
Introduction	114
Imaging	114
Digital Camera	114
Linear Imager	115
Operational Modes	115
RS507/RS507x Hands-Free Imager	116
RS6000 Bluetooth Ring Scanner	116
DS3678 Digital Scanner	117
LI3678 Linear Scanner	117
DS2278 Digital Scanner	118
Scanning Considerations	118
Scanning with Internal Imager	118
Scanning with Internal Camera	120
Scanning with RS6000 Bluetooth Ring Scanner	121
Scanning with RS507/RS507X Hands-Free Imager	122

Table of Contents

Scanning with DS3678 Bluetooth Scanner	124
Scanning with LI3678 Linear Imager	125
Scanning with DS2278 Digital Scanner	125
Pairing the RS507/RS507X/RS6000 Hands-Free Imager	126
Pairing Using Near Field Communication	126
Pairing in HID Mode Using Near Field Communication	127
Pairing Using Simple Serial Interface	128
Pairing Using Bluetooth Human Interface Device	129
Pairing a Bluetooth Scanner	130
Pairing Using Simple Serial Interface	130
Pairing Using Bluetooth Human Interface Device	131
DataWedge	132
Enabling DataWedge	132
Disabling DataWedge	132
Wireless	133
Introduction	133
Wireless Local Area Networks	133
Scanning and Connecting to a Wi-Fi Network	133
Removing a Wi-Fi Network	135
Bluetooth	135
Adaptive Frequency Hopping	135
Security	136
Bluetooth Profiles	136
Bluetooth Power States	137
Bluetooth Radio Power	137
Enabling Bluetooth	137
Disabling Bluetooth	138
Discovering Bluetooth Device(s)	138
Changing the Bluetooth Name	138
Connecting to a Bluetooth Device	138
Selecting Profiles on the Bluetooth Device	139
Unpairing a Bluetooth Device	139
Near Field Communications	139
Reading NFC Cards	140
Sharing Information Using NFC	140
Cast	141
Accessories	142
Introduction	142

Table of Contents

Accessories	142
1-Slot USB Charge Cradle	145
Charging the Device	145
Inserting a Device with Rugged Boot into Cradle	146
Battery Charging	147
Charging Temperature	147
4-Slot Charge Only Cradle with Battery Charger	147
Charging the Device	148
Inserting a TC52 with Rugged Boot into Cradle	150
Battery Charging	150
Main Battery Charging	150
Spare Battery Charging	150
Charging Temperature	151
5-Slot Charge Only Cradle	151
Charging the Device	152
Inserting a Device with Rugged Boot into Cradle	153
Battery Charging	154
Main Battery Charging	154
Charging Temperature	154
5-Slot Ethernet Cradle	154
Charging the Device	155
Inserting a TC52 with Rugged Boot into Cradle	156
Battery Charging	157
Main Battery Charging	157
Charging Temperature	157
Establishing Ethernet Connection	157
LED Indicators	157
4-Slot Battery Charger	158
Charging Spare Batteries	158
Battery Charging	159
Spare Battery Charging	159
Charging Temperature	159
Rugged Boot	159
Installation	159
Installing Stylus	161
Charging with Cradles	162
Basic Hand Strap Kit	163
Installation	164
Removal	165
2.5 mm Audio Adapter	166
3.5 mm Audio Adapter	167
Rugged Charge/USB Cable	168
Connecting to TC52	169

Table of Contents

Connecting to TC52 with Rugged Boot	170
USB Communication	170
Charging the Device	171
Disconnecting the Rugged Charge/USB Cable	171
Battery Charging	172
Main Battery Charging	172
Charging Temperature	172
Trigger Handle	172
Installing the Rugged Boot	173
Installing the Optional Lanyard	174
Inserting the Device into the Trigger Handle	175
Removing the Device from the Trigger Handle	176
Power Supply	177
Maintenance and Troubleshooting	179
Introduction	179
Maintaining the Device	179
Display Best Practices	179
Image Retention	179
Battery Safety Guidelines	180
Cleaning Instructions	180
Approved Cleanser Active Ingredients	181
Harmful Ingredients	181
Device Cleaning Instructions	181
Special Cleaning Notes	181
Recommended Cleaning Materials	182
Cleaning Frequency	182
Cleaning the Device	182
Housing	182
Display	182
Camera and Exit Window	182
Battery Guide Slots	182
Battery Connector and Locating Magnet Cleaning	183
Cleaning Cradle Connectors	183
Troubleshooting	184
TC52	184
Technical Specifications	187
Introduction	187
TC52	187

Index

About This Guide

Introduction

This guide provides information about using the TC52 touch computer and accessories.



NOTE: Screens and windows pictured in this guide are samples and can differ from actual screens.

Documentation Set

The documentation set provides information for specific user needs, and includes:

- TC52 Touch Computer Quick Start Guide - describes how to get the device up and running.
- TC52 Touch Computer User Guide for Android 8.1 Oreo - describes how to use the device.
- TC52 Touch Computer Integrator Guide for Android 8.1 Oreo - describes how to set up the device and accessories.

Configurations

This guide covers the following configurations:

Figure 1 Configurations

Configuration	Radios	Display	Memory	Data Capture Options	Operating System
TC520K-1	WLAN: 802.11 <i>a/b/g/n/ac/d/h/i/r/k/v³/w</i> WPAN: Bluetooth v5.0 Low Energy	5.0" High Definition (1280 x 720) LCD	4 GB RAM / 32 GB Flash	2D imager (SE-4710) and integrated NFC	Android-based, Google™ Mobile Services (GMS) 8.1.0
TC520K-1	WLAN: 802.11 <i>a/b/g/n/ac/d/h/i/r/k/v³/w</i> WPAN: Bluetooth v5.0 Low Energy	5.0" High Definition (1280 x 720) LCD	4 GB RAM / 32 GB Flash	2D imager (SE-4710) and integrated NFC	Android-based, AOSP 8.1.0 (China only)

Software Versions

To determine the current software versions:

1. Swipe down from the Status bar to open the Quick Settings bar.

2. Touch **⚙️** > **System**.
3. Touch **About phone**.
4. Scroll to view the following information:
 - Model
 - Android version
 - Android security patch version
 - Kernel version
 - Build number.

To determine the device serial number, touch **About phone** > **Status**.

- Serial number.

Chapter Descriptions

Topics covered in this guide are as follows:

- [Getting Started](#) provides information on getting the device up and running for the first time.
- [Using the Device](#) provides information for operating the device.
- [Applications](#) provides information on using applications installed on the device.
- [Data Capture](#) provides information for capturing bar code data using the imager.
- [Wireless](#) provides information on the various wireless options.
- [Accessories](#) provides information for using the accessories for the device.
- [Maintenance and Troubleshooting](#) includes instructions on cleaning and provides troubleshooting solutions for potential problems during device operation.
- [Technical Specifications](#) provides the technical specifications for the device.

Notational Conventions

The following conventions are used in this document:

- **Bold** text is used to highlight the following:
 - Dialog box, window and screen names
 - Drop-down list and list box names
 - Check box and radio button names
 - Icons on a screen
 - Key names on a keypad
 - Button names on a screen.
- Bullets (•) indicate:
 - Action items
 - Lists of alternatives
 - Lists of required steps that are not necessarily sequential.
- Sequential lists (e.g., those that describe step-by-step procedures) appear as numbered lists.

Related Documents

- TC52 Touch Computer Quick Start Guide, p/n MN-003215-xx.
- TC52 Touch Computer Regulatory Guide, p/n MN003216-xx.
- TC52 Touch Computer Integrator Guide for Android 8.1 Oreo, p/n MN-003147-xx.
- RS507/RS507X Hands-free Imager Product Reference Guide, p/n 72E-12082-xx.
- DS36X8 Product Reference Guide, p/n MN-002689-xx.
- RS6000 Ring Scanner User Guide, MN-002704-xx.
- DS2278 Digital Scanner Product Reference Guide, p/n, MN-002915-xx.

For the latest version of this guide and all guides, go to: zebra.com/support.

Service Information

If you have a problem with your equipment, contact Customer Support for your region. Contact information is available at: zebra.com/support.

When contacting support, please have the following information available:

- Serial number of the unit (found on manufacturing label)
- Model number or product name (found on manufacturing label)
- Software type and version number.

Customer Support responds to calls by email or telephone within the time limits set forth in support agreements.

If the problem cannot be solved by Customer Support, the user may need to return the equipment for servicing and will be given specific directions. We are not responsible for any damages incurred during shipment if the approved shipping container is not used. Shipping the units improperly can possibly void the warranty. Remove the microSD card from the device before shipping for service.

If the device was purchased from a business partner, contact that business partner for support.

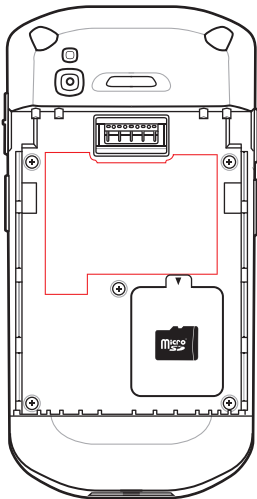

Provide Documentation Feedback

If you have comments, questions, or suggestions about this guide, send an email to EVM-Techdocs@zebra.com.

Getting Started

Introduction

This chapter provides information for getting the device up and running for the first time.

Unpacking

1. Carefully remove all protective material from the device and save the shipping container for later storage and shipping.
2. Verify that the following were received:
 - touch computer
 - 4,300 mAh (typical)/4,050 mAh (minimum) PowerPrecision+ Lithium-ion battery
 - Regulatory Guide.
3. Inspect the equipment for damage. If any equipment is missing or damaged, contact the Global Customer Support center immediately.
4. Prior to using the device for the first time, remove the protective shipping film that covers the scan window, display and camera window.

Features

Figure 2 Front View

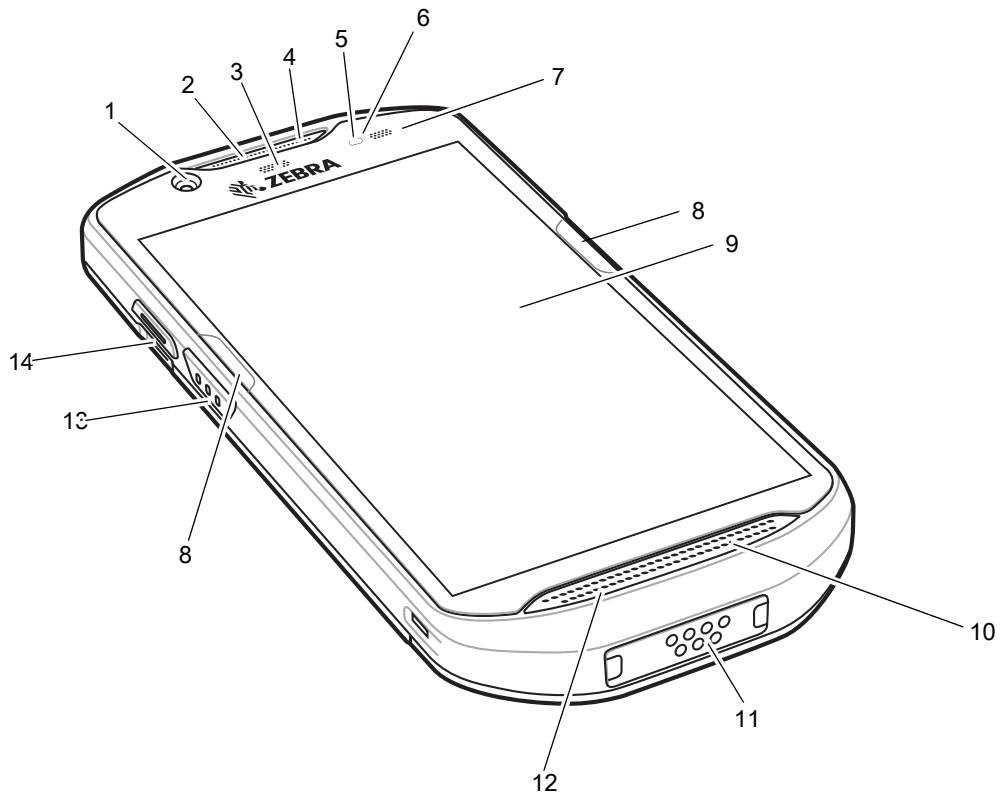

Table 1 Front View Features

Number	Item	Function
1	Front Camera	Takes photos and videos.
2	Receiver	Use for audio playback in Handset mode.
3	Data Capture LED	Indicates data capture status.
4	Microphone	Use for communications in Speakerphone mode.
5	Proximity Sensor	Determines proximity for turning off display when in handset mode.
6	Light Sensor	Determines ambient light for controlling display backlight intensity.
7	Charging/Notification LED	Indicates battery charging status while charging and application generated notifications.
8	ActiveEdge Touch Zone	Programmable dynamic soft key positioned near the perimeter of the display for one-touch access to a frequently used application or function.
9	Touch Screen	Displays all information needed to operate the device.
10	Speaker	Provides audio output for video and music playback. Provides audio in speakerphone mode.

Table 1 Front View Features (Continued)

Number	Item	Function
11	Interface Connector	Provides USB host and client communications, audio and device charging via cables and accessories. CAUTION: Do not remove the interface connector to ensure proper device sealing.
12	Microphone	Use for communications in Handset mode.
13	Scan Button	Initiates data capture (programmable).
14	PTT Button	Initiates push-to-talk communications (programmable).

Figure 3 Rear View

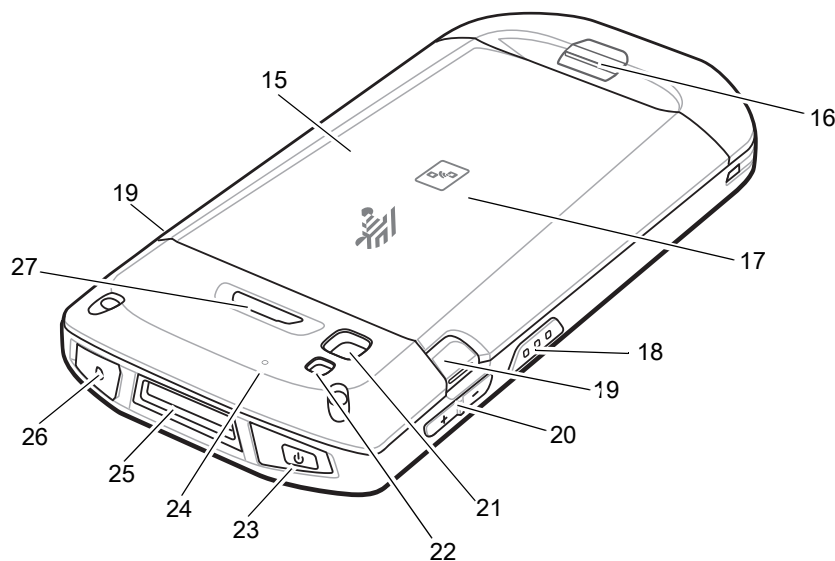

Table 2 Back View Features

Number	Item	Function
15	Battery	4,300 mAh (typical)/4,050 mAh (minimum) PowerPrecision+ Lithium-ion battery.
16	Basic Hand Strap Mount	Provides mounting point for Basic Hand Strap accessory.
17	NFC Antenna	Provides communication with other NFC-enabled devices.
18	Scan Button	Initiates data capture (programmable).
19	Battery Release Latches	Press to remove the battery.
20	Volume Up/Down Button	Increase and decrease audio volume (programmable).
21	Rear Camera	Takes photos and videos.
22	Camera Flash	Provides illumination for the camera.
23	Power Button	Turns the display on and off. Press and hold to reset the device, power off or swap battery.

Table 2 Back View Features (Continued)

Number	Item	Function
24	Microphone	Use for noise cancellation.
25	Exit Window	Provides data capture using the imager.
26	Headset Jack	For audio output to headset.
27	Programmable Button	Programmable.

Setup

Perform this procedure to start using the device for the first time.

1. Install a micro secure digital (SD) card (optional).
2. Install hand strap (optional).
3. Install the battery.
4. Charge the device.
5. Power on the device.

Installing a microSD Card

The microSD card slot provides secondary non-volatile storage. The slot is located under the battery pack. Refer to the documentation provided with the card for more information, and follow the manufacturer's recommendations for use.



CAUTION: Follow proper electrostatic discharge (ESD) precautions to avoid damaging the microSD card. Proper ESD precautions include, but are not limited to, working on an ESD mat and ensuring that the operator is properly grounded.

1. Lift the access door.

Figure 4 Lift Access Door

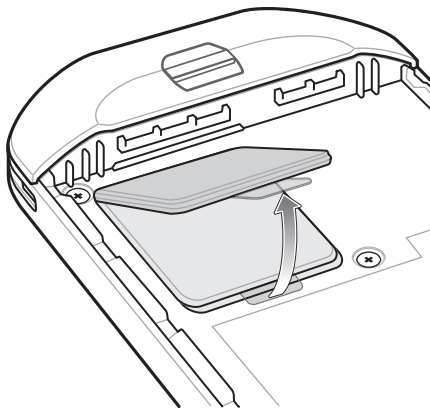

2. Slide the microSD card holder to the unlock position.

Figure 5 Unlock microSD Card Holder

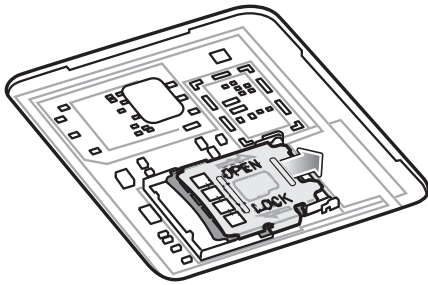

3. Lift the microSD card holder.

Figure 6 Lift the microSD Card Holder

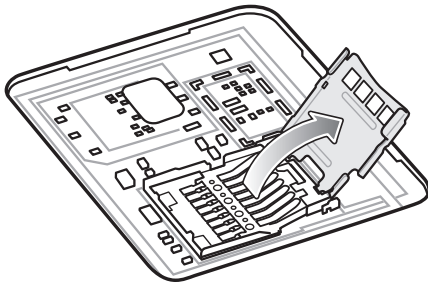

4. Insert the microSD card into the card holder door ensuring that the card slides into the holding tabs on each side of the door.

Figure 7 Insert microSD Card in Holder

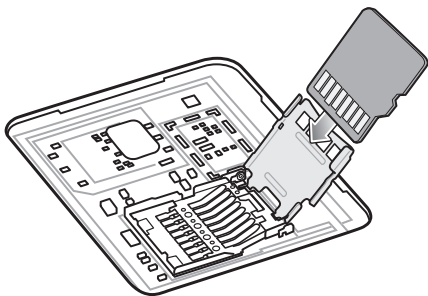

5. Close the microSD card holder and slide into the lock position.

Figure 8 Re-install Access Door

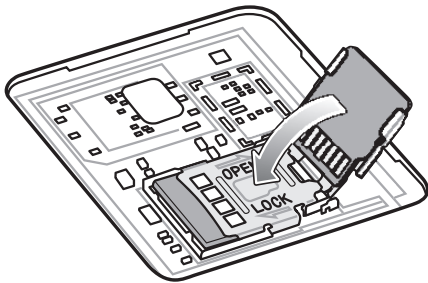

CAUTION: Access door must be replaced and securely seated to ensure proper device sealing.

6. Re-install the access door.

Figure 9 Replace Access Door

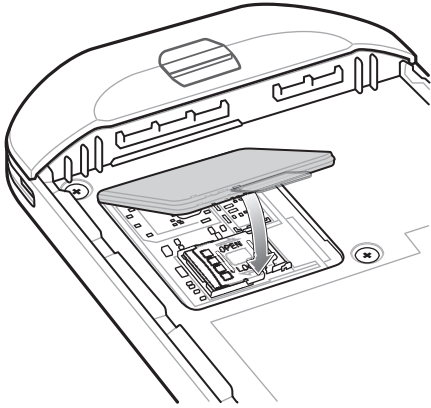

Installing the Battery

1. Insert the battery, bottom first, into the battery compartment in the back of the device.

Figure 10 Insert Bottom of Battery into Battery Compartment

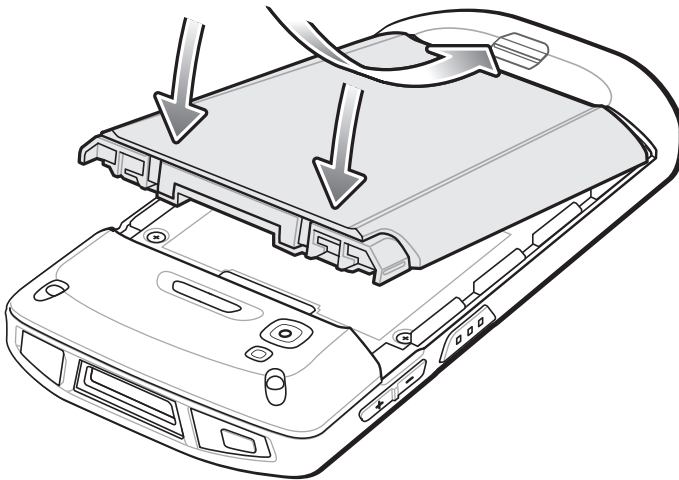

2. Press the battery down into the battery compartment until the battery release latches snap into place.

Charging the Battery

Before using the device for the first time, charge the main battery until the green Charging/Notification light emitting diode (LED) remains lit. To charge the device use a cable or a cradle with the appropriate power supply. For information about the accessories available for the device see [Accessories](#) for more information.

The battery charges from fully depleted to 90% in approximately 2.5 hours and from fully depleted to 100% in approximately three hours.



NOTE: In many cases the 90% charge provides plenty of charge for daily use. A full 100% charge lasts for approximately 14 hours of use.

To achieve the best fast charging results use only Zebra charging accessories and batteries. Charge batteries at room temperature with the device in sleep mode.







Charge batteries in temperatures from 5°C to 40°C (°F to 104°F). The device or accessory always performs battery charging in a safe and intelligent manner. At higher temperatures (e.g. approximately +37°C (+98°F)) the device or accessory may for small periods of time alternately enable and disable battery charging to keep the battery at acceptable temperatures. The device or accessory indicates when charging is disabled due to abnormal temperatures via its LED and a notification appears on the display.

To charge the main battery:

1. Connect the charging accessory to the appropriate power source.
2. Insert the device into a cradle or attach to a cable. The device turns on and begins charging. The Charging/Notification LED blinks amber while charging, then turns solid green when fully charged.

Charging Indicators

Table 3 Charging/Notification LED Charging Indicators

State	LED	Indication
Off		Device is not charging. Device is not inserted correctly in the cradle or connected to a power source. Charger/cradle is not powered.
Slow Blinking Amber (1 blink every 4 seconds)		Device is charging.
Slow Blinking Red (1 blink every 4 seconds)		Device is charging but the battery is at end of useful life.
Solid Green		Charging complete.
Solid Red		Charging complete but the battery is at end of useful life.
Fast Blinking Amber (2 blinks/second)		Charging error, e.g.: <ul style="list-style-type: none"> • Temperature is too low or too high. • Charging has gone on too long without completion (typically eight hours).
Fast Blinking Red (2 blinks/second)		Charging error but the battery is at end of useful life., e.g.: <ul style="list-style-type: none"> • Temperature is too low or too high. • Charging has gone on too long without completion (typically eight hours).

Google Account Setup



NOTE: The device has to be connected to the internet in order to set up a Google™ account. A Google account is only required on devices with GMS software.

The first time the device starts, the Setup Wizard displays. Follow the on-screen instructions to set up a Google account, configure Google Wallet for purchasing items from the Play Store, to enter your personal information, and enable backup/restore features.

Zebra Visibility Services

The device captures and provides device analytics to a system administrator. The first time the device boots (or after a Factory reset), the **Zebra Services** agreement screen displays.

Figure 11 Zebra Services

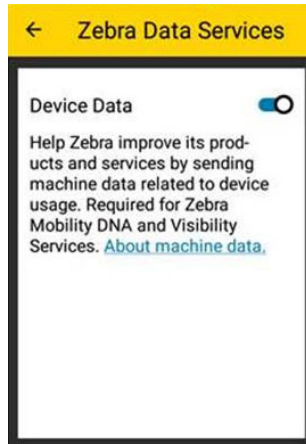

Touch the **Device Data** switch to disable the device from sending analytics data.

Replacing the Battery



CAUTION: Do not add or remove microSD card during battery replacement.

1. Press the Power button until the menu appears.
2. Touch **Battery Swap**.
3. Follow the on-screen instructions.



WARNING: Do not remove the battery until after the red LED completely turns off. Loss of data may result.

4. Wait for the red LED to completely turn off.
5. If hand strap is attached, remove hand strap.
6. Press the two battery latches in.

Figure 12 Press Battery Latches

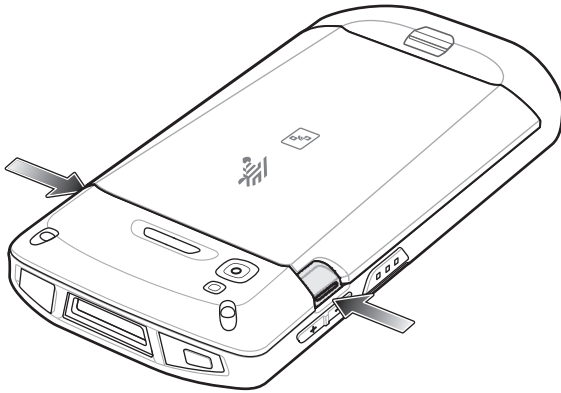

7. Lift the battery from the device.

Figure 13 Lift the Battery

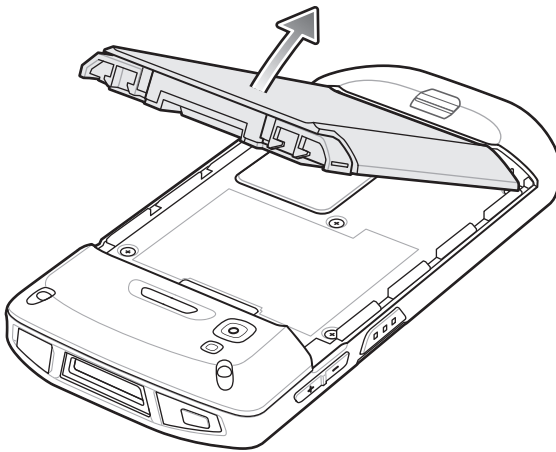

CAUTION: Replace the battery within 75 seconds. After 75 seconds the device reboots and data may be lost.

8. Insert the replacement battery, bottom first, into the battery compartment in the back of the device.
9. Press the battery down until the battery release latches snap into place.
10. Replace the hand strap, if required.
11. Press the Power button to turn on the device.

Replacing the microSD Card

To replace the microSD card:

1. Press the Power button until the menu appears.
2. Touch **Power off**.
3. Touch **OK**.
4. If hand strap is attached, slide the hand strap clip up toward the top of the device and then lift.

5. Press the two battery latches in.
6. Lift the battery from the device.
7. Lift the access door.

Figure 14 Remove Access Door

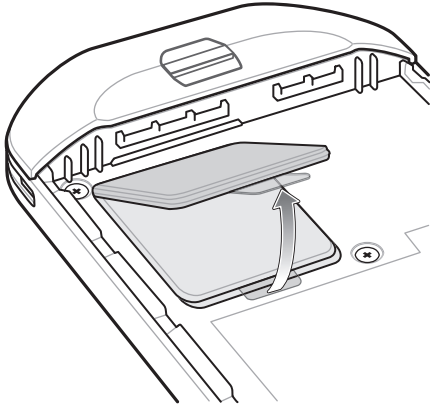

8. Remove microSD card from holder.
9. Insert the replacement microSD card.



CAUTION: Access door must be replaced and securely seated to ensure proper device sealing.

10. Replace the access door.

Figure 15 Replace Access Door

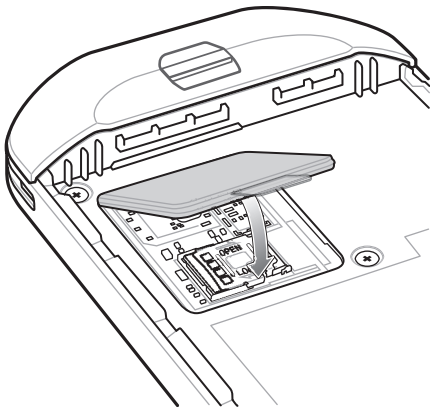

11. Insert the battery, bottom first, into the battery compartment in the back of the device.
12. Press the battery down until the battery release latches snap into place.
13. Replace the hand strap, if required.
14. Press and hold the Power button to turn on the device.

Accessing Device Settings

To access device settings:

1. Swipe down from the Status bar to open the Quick Settings bar and then touch .

2. On the Home screen, swipe up from the bottom of the screen and touch .

Battery Management



NOTE: Prior to checking the battery charge level, remove the device from any AC power source (cradle or cable).

To check the charge status of the main battery, open **Settings** and touch **System > About phone > Battery Information**.

Alternately, swipe up from the bottom of the screen and touch  to open the **Battery Manager** app. Touch **Advanced info**. See [Battery Manager on page 67](#).

Battery present status indicates if the battery is present and **Battery level** lists the battery charge (as a percentage of fully charged). The battery percentage can also be viewed next to the battery icon in the quick access panel. Swipe down with two fingers from the status bar to open the quick access panel.

Monitoring Battery Usage

The **Battery** screen provides battery charge details, power management options, and a list of which apps consume the most battery power.

Use the power management options to extend battery life, or touch an app to display details about its power consumption. Different apps display different information. Some apps include buttons that open screens with settings to adjust power use. Use the **DISABLE** or **FORCE CLOSE** buttons to turn off apps that consume too much power.

1. Swipe down from the Status bar to open the Quick Settings bar and then touch .
2. Touch **Battery**.

Figure 16 Battery Screen



Low Battery Notification

When the battery charge level drops below 18%, the device displays a notice to connect the device to power. The user should charge the battery using one of the charging accessories.

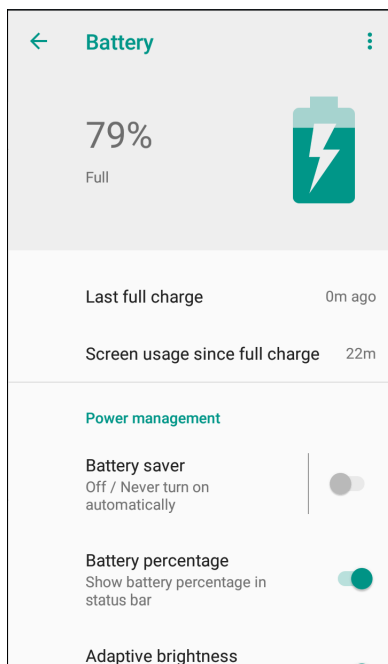
When the battery charge drops below 10%, the device displays a notice to connect the device to power. The user must charge the battery using one of the charging accessories.

When the battery charge drops below 4%, the device turns off. The user must charge the battery using one of the charging accessories.

Figure 17 Low Battery Notification

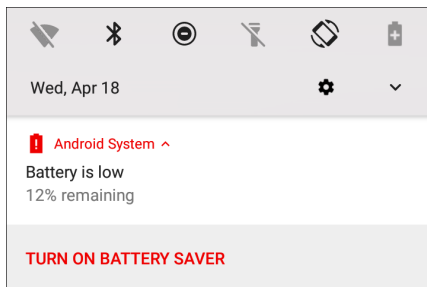

Battery Optimization

Observe the following battery saving tips:

- Disable DataWedge Launcher profile. Refer to the Integrator Guide for Android 8.1 for this device.
- Set the screen to turn off after a short period of non-use.
- Reduce screen brightness.
- Turn off all wireless radios when not in use.
- Turn off automatic syncing for Email, Calendar, Contacts, and other apps.
- Minimize use of apps that keep the device from suspending, for example, music and video apps.
- Enable Battery Saver mode. Swipe down from the Status bar and then touch **Battery saver**.

Setting the Date and Time

The user is only required to set the time zone or set the date and time if the wireless LAN does not support Network Time Protocol (NTP).

To set the date and time:

1. Swipe down from the Status bar to open the Quick Settings bar and then touch .
2. Touch **System > Date & time**.
3. Touch **Automatic date & time** to disable automatic date and time synchronization.
4. Touch **Automatic time zone** to disable automatic time zone synchronization.
5. Touch **Set date**.
6. In the calendar, set today's date.

7. Touch **OK**.
8. Touch **Set time**.
9. Touch the green circle, drag to the current hour and then release.
10. Touch the green circle, drag to the current minute and then release.
11. Touch **AM** or **PM**.
12. Touch **OK**.
13. Touch **Select time zone**.
14. Select the current time zone from the list.
15. Touch .

Display Settings

Use Display settings to change the screen brightness, enable night light, change the background image, enable screen rotation, set sleep time and change font size.

Setting the Screen Brightness

To manually set the screen brightness:

1. Swipe down with two fingers from the Status bar to open the Quick Access panel.
2. Slide the icon to adjust the screen brightness level.

Figure 18 Brightness Slider



To let the device automatically adjust the screen brightness using the built-in light sensor:

1. Swipe down from the status bar to open the quick settings bar and then touch .
2. Touch **Display**.
3. If disabled, touch **Adaptive brightness** to automatically adjust the brightness.
By default, **Adaptive brightness** is enabled. Toggle the switch to disable.
4. Touch .

Setting Screen Rotation

By default, screen rotation is enabled.

To disable screen rotation:

1. Swipe down from the Status bar to open the Quick Settings bar and then touch .
2. Touch **Display > Advanced**.

3. Touch **Auto-rotate screen**.



NOTE: To change the Home screen rotation, see [Setting Home Screen Rotation on page 29](#).

4. Touch .

Setting Home Screen Rotation

By default the Home screen rotation is disabled. To enable Home screen rotation:



NOTE: Screen rotation must be enabled to rotate the Home screen.

1. Touch and hold anywhere on the Home screen until the options appear.
2. Touch **HOME SETTINGS**.
3. Touch **Allow Home screen rotation**.
4. Touch .
5. Rotate the device.

Figure 19 Rotated Home Screen

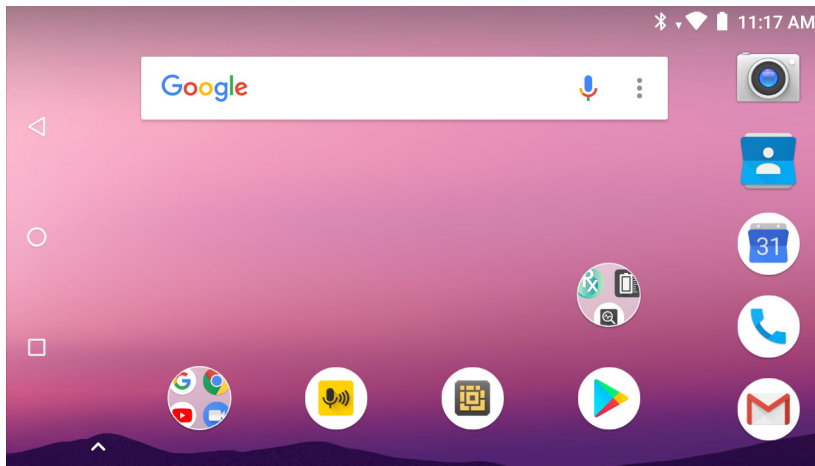

Setting Screen Timeout

To set the screen sleep time:

1. Swipe down from the Status bar to open the Quick Settings bar and then touch .
2. Touch **Display > Advanced > Sleep**.

3. Select one of the sleep values.
 - **15 seconds**
 - **30 seconds**
 - **1 minute** (default)
 - **2 minutes**
 - **5 minutes**
 - **10 minutes**
 - **30 minutes.**
4. Touch .

Setting Font Size

To set the size of the font in system apps:

1. Swipe down from the Status bar to open the Quick Settings panel and then touch .
2. Touch **Display > Advanced**.
3. Touch **Font size**.

Figure 20 Font Settings



4. Select one of the font size values.
 - Small
 - Default
 - Large
 - Largest.
5. Touch .

Ambient Display

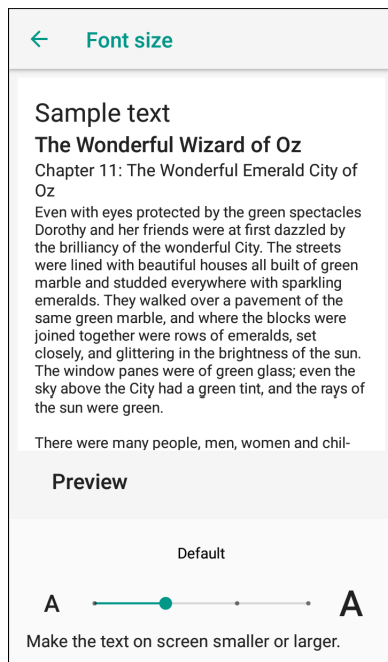
The Ambient display setting wakes the screen when notifications are received.

To disable ambient display:

1. Swipe down from the Status bar to open the Quick Settings bar and then touch .
2. Touch **Display > Advanced**.
3. Touch **Ambient display**.
4. In the **When to show** section, enable or disable an option using the switch.
5. Touch .

Touch Panel Mode

The device display is able to detect touches using a finger, a conductive-tip stylus, or gloved finger.



NOTE: A glove can be made of medical latex, leather, cotton, or wool.
For optimal performance use a Zebra certified stylus.



1. Swipe down from the Status bar to open the Quick Settings bar and then touch .
2. Touch **Display > Advanced**.
3. Touch **Touch panel mode**.

Figure 21 Screen Protector Mode Dialog Box



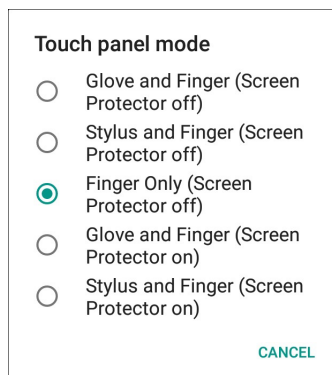

4. Select:
 - a. **Glove and Finger (Screen Protector off)** to use a finger or a gloved finger on the screen without a screen protector.
 - b. **Stylus and Finger (Screen Protector off)** to use a finger or a stylus on the screen without a screen protector.
 - c. **Finger Only (Screen Protector off)** to use a finger on the screen without a screen protector.
 - d. **Glove and Finger (Screen Protector on)** to use a finger or a gloved finger on the screen with a screen protector.
 - e. **Stylus and Finger (Screen Protector on)** to use a finger or a stylus on the screen with a screen protector.

5. Touch .

Setting Notification LED

The Charging/Notification LED lights blue when an application, such as email and VoIP, generates a programmable notification or to indicate when the device is connected to a Bluetooth device. By default, LED notifications are enabled. To change the notification setting:

1. Swipe down with two fingers from the status bar to open the quick access panel and then touch .
2. Touch **Apps & notifications > Notifications**.
3. Touch **Blink light** to toggle the notification on or off.
4. Touch .

General Sound Setting

Use the **Sound** settings to configure media and alarm volumes.

To access sound settings:





1. Swipe down from the Status bar to open the Quick Settings bar and then touch .
2. Touch **Sound**.
3. Touch an option to set sounds.

Figure 22 Sound Screen

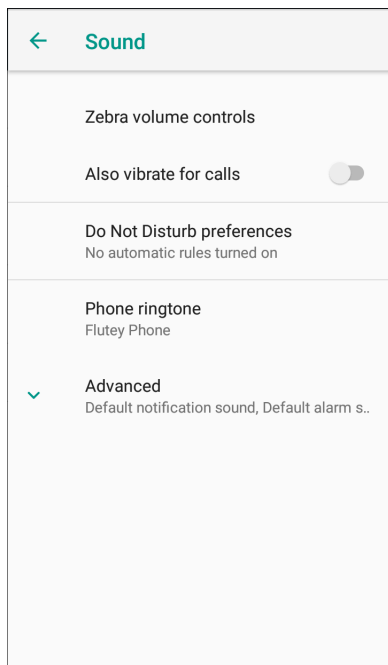

- **Zebra volume controls**
 - **Ring volume** - Controls the ringtone volume.
 - **Media volume** - Controls the music, games, and media volume.
 - **Alarm volume** - Controls the alarm clock volume.
 - **Notifications volume** - Controls the notification volume.
 - **Scanner volume** - Controls the scanner volume.
 - Volume Presets
 -  - Mutes the ring, notifications, and scanner so that the device does not make sounds or vibrate.
 -  - All sounds except media and alarms are silenced and vibrate mode is active.
 -  - Enables all sounds at the user defined levels.
- **Also vibrate for calls** - Switch on or off.
- **Do Not Disturb preferences** - Mutes some or all sounds and vibrations.
 - **Priority only allows** - Use to set the priorities for the following:
 - **Reminders** - Switch on or off.
 - **Events** - Switch on or off.
 - **Alarms** - This is always enabled.
 - **Messages** - Choose to allow messages from anyone, starred contacts, any contact, or none. To star contacts, use the Contacts app.
 - **Block visual disturbances**
 - **Block when screen is on** - This option prevents notifications from displaying over the screen (peeking) while you are actively using the device.
 - **Block when screen is off** - This option prevents notifications from turning on the screen or pulsing the LED light when a new notification is received while you are not using the device.
 - **Automatic rules** - Choose when to automatically silence the device. Touch a default rule, such as Weekend or Weeknight, or create your own rule. To create your own rule, tap **Add more** and then **Time rule**.
- **Advanced** - Touch to display advanced sound options.
 - **Default notification sound** - Touch to select a sound to play for all system notifications.
 - **Default alarm sound** - Touch to select a sound to play for alarms.
 - **Other sounds and vibrations**
 - **Dial pad tones** - Play a sound when pressing keys on dial pad (default - disabled).
 - **Screen locking sounds** - Play a sound when locking and unlocking the screen (default – enabled).
 - **Charging sounds** - Not applicable.
 - **Touch sounds** - Play a sound when making screen selections (default – enabled).
 - **Vibrate on tap** - Vibrate the device when making screen selections (default – disabled).
 - **Emergency alerts** - Touch to configure emergency broadcast settings and notifications.

Wake-Up Sources

By default the device wakes from suspend mode when the user presses the power button. The device can be configured to wake when the user presses the PTT or Scan buttons on the left side of the device.

1. Swipe down with two fingers from the status bar to open the quick access panel and then touch .
2. Touch **Wake-Up Sources**.

3. Touch one or more of the options:
 - Touch **SCAN** checkbox to enable the left scan button. A check appears in the checkbox.
 - Touch **RIGHT_TRIGGER_2** checkbox to enable the right scan button. A check appears in the checkbox.
 - Touch **LEFT_TRIGGER_2** checkbox to enable the PTT button. A check appears in the checkbox.
 - Touch **REAR_BUTTON** checkbox rear programmable button. A check appears in the checkbox.

Figure 23 Wake-Up Sources

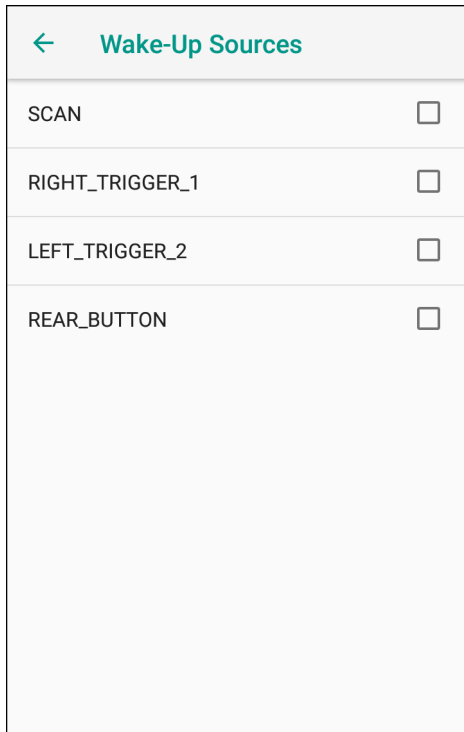

4. Touch ○.

Using the Device

Introduction

This chapter explains the buttons, status icons, and controls on the device, and provides basic instructions for using the device including resetting the device and entering data.

Google Mobile Services



NOTE: This section applies to Google Mobile Services (GMS) devices only.

Devices with GMS contain apps and services that provide additional functionality.

GMS includes:

- Apps - GMS adds a variety of Google apps and associated widgets including Chrome, Gmail, Drive, and Maps.
- Services:
 - Speech to Text - Allows for free format speech to text in many languages for both connected and disconnected network. Launch by touching the microphone icon on the keyboard.
 - TalkBack Service - Provides spoken feedback on various parts of the user interface. To enable, go to **Settings > Accessibility**.
 - Network Location Provider - Adds a location provider which uses mobile network tower information and Wi-Fi access point information to provide a location without using GPS. To enable, go to **Settings > Location access**.
 - Widevine DRM - Enables Digital Rights Management (DRM) so that protected streaming video content can be played. Enable DRM Info from the Google Play store.
 - Google Cloud Messaging - Allows the device to receive data from the server and other devices on the same connection.
 - Backup and Restore - Allows the users settings and apps to be backed up to a Google server and subsequently restored from that server after a factory reset.
- Google Accounts - Create and use a Google account to synchronize mail, files, music, photos, contacts and calendar events.

Home Screen

The Home screen displays when the device turns on. Depending upon the configuration, the Home screen might appear different. Contact your system administrator for more information.

After a suspend or screen time-out, the Home screen displays with the lock sliders. Touch the screen and slide up to unlock. For screen locking information see [Un-Locking the Screen on page 53](#).

Figure 24 Home Screen



Table 4 Home Screen Items

Item	Description
1 — Recent Button	Displays recently used applications.
2 — Home	Displays the Home screen.
3 — Back	Displays the previous screen.
4 — Shortcut Icons	Opens applications installed on the device. See App Shortcuts and Widgets on page 42 for more information.
5 — Status Bar	Displays the time, status icons (right side), and notification icons (left side). For more information see Status Bar on page 37 and Managing Notifications on page 38 .
6 — App Menu	Opens the All App window listing all installed apps.

The Home screen provides four additional screens for placement of widgets and shortcuts. When available, swipe the screen left or right to view the additional screens. The additional screens are not viewable by default.

Status Bar

The Status bar displays the time, notification icons (left side), and status icons (right side).



NOTE: Some Status icons may not appear in the Status bar if there are too many icons to display.

Figure 25 Notification and Status Icons



If there are more notifications than can fit in the Status bar, two dots display indicating that more notifications exist. Swipe down from the Status bar to open the Notification panel and view all notifications and status.



















Status Icons

Table 5 Status Icons

Icon	Description
	Alarm is active.
	Main battery is fully charged.
	Main battery is partially drained.
	Main battery charge is low.
	Main battery charge is very low.
	Main battery is charging.
	All sounds, except media and alarms, are silenced and vibrate mode is active.
	Do Not Disturb mode active.
	Airplane Mode is active. All radios are turned off.
	Bluetooth is on.
	The device is connected to a Bluetooth device.
	Connected to a Wi-Fi network.
	Not connected to a Wi-Fi network or no Wi-Fi signal.
	Connected to an Ethernet network.
	Speakerphone enabled.

Notification Icons

Table 6 Notification Icons

Icon	Description
	Main battery is low.
	More notifications are available for viewing.
	Data is syncing.
	Indicates an upcoming event. Non-GMS devices only.
	Indicates an upcoming event. GMS devices only.
	Open Wi-Fi network is available.
	Song is playing.
	Problem with sign-in or sync has occurred.
	Device is uploading data.
	Device is downloading data when animated and download is complete when static.
	Device is connected via USB cable.
	Device is connected to or disconnected from virtual private network (VPN).
	Preparing internal storage by checking it for errors.
	USB debugging is enabled on the device.
	Headset is connected to the device.
	PTT Express Voice client status. See the PTT Express PTT Notification Icons on page 101 for a complete list.
	Indicates that RxLogger app is running.
	Indicates the RS6000 is connected to the device.
	Indicates the RS507 or RS6000 is connected to the device in HID mode.

Managing Notifications

Notification icons report the arrival of new messages, calendar events, alarms, and ongoing events. When a notification occurs, an icon appears in the Status bar with a brief description. See [Notification Icons on page 38](#) for a list of possible notification icons and their description. Open the Notification panel to view a list of all the notifications.

To open the Notification panel, drag the Status bar down from the top of the screen.

Figure 26 Notification Panel

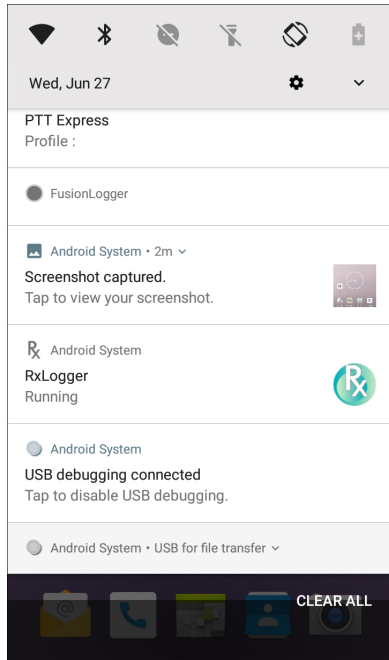

To respond to a notification, open the Notification panel and then touch a notification. The Notification panel closes and the corresponding app opens.

To clear all notifications, open the Notification panel and then touch **CLEAR ALL**. All event-based notifications are removed. Ongoing notifications remain in the list.

To close the Notification panel, swipe the Notification panel up.

Setting App Notifications

To set notification settings for a specific app:

1. Swipe down from the Status bar to open the Quick Settings bar and then touch **⚙️**.
2. Touch **Apps & notifications > Notifications > App notifications**.
3. Select an app.
4. Select an available option:
 - **On / Off** - Select to turn all notifications from this app **On** (default) or **Off**.
 - **Allow notification dot** - Do not allow this app to add a notification dot to the app icon.
 - **Allow interruptions** - Do not allow notifications from this app to make sound, vibrate, or pop notifications on the screen.
 - **Override Do Not Disturb** - Allow these notifications to interrupt when Do Not Disturb is set to Priority Only.
 - **Categories** - Do not allow specific types of notifications from this app.
 - **Additional settings in the app** - Open the app settings.



NOTE: To change the notification settings for an app, slide the notification slightly left or right and touch **⚙️**.

Viewing Notification Settings for All Apps

To view the notification settings for all apps:

1. Swipe down from the Status bar to open the Quick Settings bar and then touch .
2. Touch **Apps & Notifications**.
3. Scroll down to **Notifications** to view how many apps have notifications turned off.
4. To set or view notifications settings for a specific app, see [Setting App Notifications on page 39](#).

Controlling Lock Screen Notifications

To control whether notifications can be seen when the device is locked:

1. Swipe down from the Status bar to open the Quick Settings bar and then touch .
2. Touch **Apps & notifications > Notifications**.
3. Touch **On the lock screen** and select one of the following:
 - **Show all notification content** (default)
 - **Don't show notifications at all**.

Quick Access Panel

Use the Quick Access panel to access frequently used settings (for example, Airplane mode).

Figure 27 Quick Settings Bar

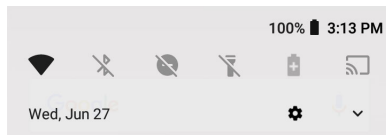

To see the full Quick Access panel:

- If the device is locked, swipe down once.
- If the device is unlocked, swipe down once with two fingers, or twice with one finger.

- If the Quick Settings bar is open, touch the Down arrow.

Figure 28 Quick Access Panel

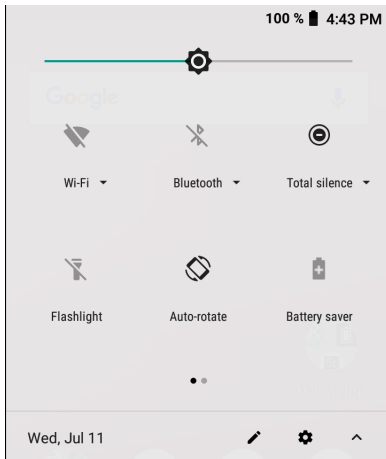

NOTE: Not all icons are pictured. Icons may vary.

To change a setting, touch the icon:

- Display brightness - Use the slider to decrease or increase the brightness of the screen.
- Wi-Fi network - Turn Wi-Fi on or off. To open Wi-Fi settings, touch the Wi-Fi network name.
- Bluetooth settings - Turn Bluetooth on or off. To open Bluetooth settings, touch **Bluetooth**.
- Battery saver - Turn Battery saver mode on or off. When Battery saver mode is on the performance of the device is reduced to preserve battery power.
- Invert colors - Invert the display colors.
- Do not disturb - Control how and when to receive notifications.
- Airplane mode - Turn Airplane mode on or off. When Airplane mode is on the device does not connect to Wi-Fi or Bluetooth.
- Auto-rotate - Lock the device's orientation in portrait or landscape mode or set to automatically rotate.
- Flashlight - Turn flashlight on or off. Turn camera flash on or off.
- Location - Enable or disable locationing feature.
- Night Light - Tint the screen amber to make it easier to look at the screen in dim light. Set Night Light to turn on automatically from sunset to sunrise, or at other times.
- Nearby - Helps find and interact with services and devices close to the device.
- Cast - Share phone content on Chromecast or a television with Google Cast built-in. Touch cast screen to display a list of devices, then touch a device to begin casting.

Editing Icons on Quick Settings



The first several setting tiles from the Quick Access panel become the Quick Settings bar.

To move a setting tile:



1. Open the Quick Access panel.
2. Touch .
3. Touch and drag a setting tile to another location.

4. Release the tile.
5. Touch  to save tiles and return to the Quick Access panel.

To add a setting tile:

1. Open the Quick Access panel.
2. Touch .
3. Slide the Quick Settings panel up to reveal additional tiles.
4. Touch and drag a setting tile from the **Drag to add tiles** area to the main area.
5. Release the tile.
6. Touch  to save tiles and return to Quick Access panel.

To remove a setting tile:

1. Open the Quick Access panel.
2. Touch .
3. Touch and drag a setting tile to the **Drag here to remove** area.
4. Release the tile.
5. Touch  to save tiles and return to Quick Access panel.

App Shortcuts and Widgets

App shortcuts placed on the Home screen allow quick and easy access to apps. Widgets are self-contained apps placed on the Home screen to access frequently used features.

Adding an App Shortcut to the Home Screen

To add an app shortcut to the Home screen:

1. Go to the desired Home screen.
2. Swipe up from the bottom of the screen.
3. Scroll through the list to find the app icon.
4. Touch and hold the icon until the Home screen appears.
5. Position the icon on the screen and then release.

Adding a Widget to the Home Screen

To add a widget to the Home screen:

1. Go to the desired Home screen.
2. Touch and hold until the menu appears.
3. Touch **WIDGETS**.
4. Scroll through the list to find the widget.
5. Touch and hold the widget until the Home screen appears.

6. Position the widget on the screen and then release.

Moving Items on the Home Screen

To move app shortcuts or widgets on the Home screen:

1. Touch and hold the item until it floats on the screen.
2. Drag the item to a new location. Pause at the edge of the screen to drag the item onto an adjacent Home screen.
3. Lift finger to place the item on the Home screen.

Removing an App Shortcut or Widget from the Home Screen

To remove an app shortcut or widget from the Home screen:

1. Go to the desired Home screen.
2. Touch and hold the app shortcut or widget icon until it floats on the screen.
3. Drag the icon to **X Remove** at the top of the screen and then release.

Folders

Use **Folders** to organize similar applications together. Tap the folder to open and display items in the folder.

Creating a Folder

There must be at least two app icons on the Home screen.

To create a folder:

1. Go to the desired Home screen.
2. Touch and hold one app icon.
3. Drag the icon and stack on top of another icon.
4. Lift and release.

Naming Folders

To name a folder:

1. Touch the folder.

Figure 29 Open Folder

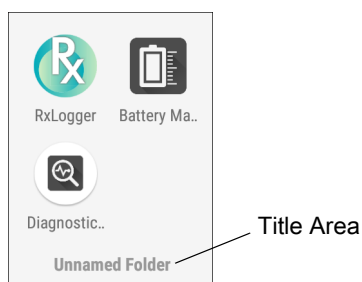

2. Touch the title area and enter a folder name using the keyboard.
3. Touch  on the keyboard.
4. Touch anywhere on the Home screen to close the folder. The folder name appears under the folder.

Removing a Folder

To remove a folder:

1. Touch and hold the folder icon until it enlarges.
2. Drag the folder to **X Remove** and release.

Home Screen Wallpaper

To change the Home screen wallpaper:

1. Touch and hold the screen until the menu appears.
2. Touch **WALLPAPERS**.
3. Touch **Photos** or **Gallery** to select a photo or select one of the pre-installed wallpapers.
4. Touch **Set wallpaper**.

Using the Touchscreen

Use the multi-tap sensitive screen to operate the device.

- Tap - Tap to:
 - Select items on the screen.
 - Type letters and symbols using the on-screen keyboard.
 - Press on-screen buttons.
- Tap and Hold - Tap and hold:
 - An item on the Home screen to move it to a new location or to the trash.
 - An item in Apps to create a shortcut on the Home screen.
 - The Home screen to open a menu for customizing the Home screen.
 - An empty area on the Home screen until the menu appears.
- Drag - Tap and hold an item for a moment and then move finger on the screen until reaching the new position.
- Swipe - Move finger up and down or left and right on the screen to:
 - Unlock the screen.
 - View additional Home screens.
 - View additional app icons in the Launcher window.
 - View more information on an app's screen.
- Double-tap - Tap twice on a web page, map, or other screen to zoom in and out.
- Pinch - In some apps, zoom in and out by placing two fingers on the screen and pinching them together (to zoom out) or spreading them apart (to zoom in).

Keyboards

Use the on-screen keyboard to enter text in a text field.

Editing Text

Edit entered text and use menu commands to cut, copy, and paste text within or across apps. Some apps do not support editing some or all of the text they display; others may offer their own way to select text.

Entering Numbers, Symbols, and Special Characters

To enter numbers and symbols:

- Touch and hold one of the top-row keys until a menu appears then select a number or special character.
- Touch the Shift key once for a single capital letter. Touch the Shift key twice to lock in uppercase. Touch the Shift key a third time to unlock Capslock.
- Touch **123** to switch to the numbers and symbols keyboard.
- Touch the **=\<** key on the numbers and symbols keyboard to view additional symbols.

To enter special characters, touch and hold a number or symbol key to open a menu of additional symbols. A larger version of the key displays briefly over the keyboard.

Keyboard Configuration



Enabling Keyboards

To enable keyboards:

1. Swipe down from the Status bar to open the Quick Settings bar and then touch .
2. Touch **System > Languages & input > Virtual keyboard > Manage keyboards**.
3. Touch a keyboard to enable.

Switching Between Keyboards

To switch between keyboards, touch in a text box to display the current keyboard.

- On the Android or Gboard keyboards, touch and hold .
- On the Enterprise keyboard, touch .

Do Not Disturb Feature

This mode mutes the device so that it does not make sounds or vibrate.

For example, use Do Not Disturb to:

- Automatically limit sounds at night or during events
- Mute interruptions other than alarms
- Get alerted to messages only from favorite contacts.

Limit Sounds and Vibrations

Mute the device completely, or let through the important alarms or important calls.

Total Silence

To completely mute the device so that it does not make a sound or vibrate, choose **Total silence**.

In Total silence mode:

- Alarms do not make noise.
- Device does not vibrate or make sounds when receiving a message, or notification.
- Sounds from music, videos, games, and other media are muted.



NOTE: All alarms are silenced in Total silence mode.

1. Swipe down with two fingers from the Status bar to open the Quick Access panel.
2. Touch **Do not disturb > Total silence**.
3. Choose **Until you turn it off** or select a time period.
4. Touch **Done**.

When Total Silence is on,  appears in the quick access panel and the Status bar.

To turn off Total Silence, open quick access panel and touch **Total silence**.

Alarms Only

To mute the device so that the user hears alarms, choose **Alarms only**. This option does not mute sounds from music, videos, games, or other media.

1. Swipe down with two fingers from the status bar to open the quick access panel.
2. Touch **Do not disturb > Alarms only**.
3. Choose **Until you turn it off** or select a time period.
4. Touch **Done**.

When Alarms Only is on,  appears in the quick access panel and the Status Bar.

To turn off Alarms Only, open the Quick Access panel and touch **Alarms only**.



NOTE: To quickly turn on Alarms Only, with the screen on, press and hold the Volume Down button until the volume is all the way down. Then, press Volume Down again to turn on Alarms Only.

To turn off Alarms Only, press either the Volume Up or Volume Down button and the touch **END NOW** in the alert message.

Automatically Block Sounds and Vibrations

Automatically silence the device during certain times or events, turn sounds back on, and override Do Not Disturb mode.

Silence Sounds During Certain Times

To automatically silence the device during certain times, like at night or on weekends:



1. Swipe down from the Status bar to open the Quick Settings bar and then touch .
2. Touch **Sound > Do Not Disturb preferences**.
3. Touch a default **Weekend** or **Weeknight**. Or, to make a new rule, touch **Add more > Time rule**.
4. Enter a rule name.
5. Touch **OK**.
6. Edit the new rule:
 - **Rule name** - Rename the rule.
 - **Days, Start time, and End time** - Set the rule's schedule.
 - **Do Not Disturb preferences** - Choose whether the rule uses **Alarms only**, **Priority only**, or **Total silence**.
 - **Alarm can override end time** - Allow the alarm to continue to make sound until the next alarm begins.
7. Touch the On/Off switch at the top to turn on the rule.

Silence Sounds During Events and Meetings

To automatically silence the device during events or meetings, set an event rules.

1. Swipe down from the Status bar to open the Quick Settings bar and then touch .
2. Touch **Sound > Do Not Disturb preferences**.
3. To edit the default rule, touch **Event**. Or, to create a new rule, touch **Add rule > Event rule**.
4. Edit the rule settings.
 - **Rule name** - Rename the rule.
 - **During events for** - Select which Google Calendar events the rule uses.
 - **Where reply is** - Set to: **Yes, Maybe, or Not replied, Yes or Maybe, or Yes**.
 - **Do Not Disturb preferences** - Choose whether the rule uses **Priority only**, **Alarms only**, or **Total silence**.
5. Touch the On/Off switch at the top to turn on the rule.

Turn Sounds Back On

When the device is in Do Not Disturb mode, Alarms only or Priority only display as , or Total silence displays as .

To turn off Do Not Disturb, either:

- In the Quick Access panel, touch **Alarms only**, **Priority only**, or **Total silence**.
- Press the Volume Down button and touch **End Now**.

Override Do Not Disturb for Specific Apps

To let through notifications from specific apps:

1. Swipe down from the Status bar to open the Quick Settings bar and then touch .
2. Touch **Apps & notifications > Notifications > App notifications**.
3. Touch an app.
4. Touch **Override Do Not Disturb**.

Apps

The **APPS** screen displays icons for all installed apps. The table below lists the apps installed on the device. Refer to the device Integrator Guide for Android Version 8.1 for information on installing and uninstalling apps.

Table 7 Apps











Icon	Description
	ActiveEdge Touch Zone - Provides quick and convenient on-touch access to key features or applications while users are in the middle of other workflow applications or tasks.
	Battery Manager - Displays battery information, including charge level, status, health and wear level.
	Battery Swap – Use to place device in Battery Swap mode when replacing the battery.
	Bluetooth Pairing Utility – Use to pair the RS507 Hands-free Imager with the device by scanning a barcode.
	Calculator - Provides the basic and scientific arithmetic functions.
	Calendar - Use to manage events and appointments. GMS/GMS-Restricted only.
	Calendar - Use to manage events and appointments. AOSP only.
	Camera - Take photos or record videos. For more information see Camera on page 70 .
	Chrome - Use to access the Internet or intranet. GMS/GMS-Restricted only.
	Chromium - Use to access the Internet or intranet. AOSP only.
	Clock - Use to schedule alarms for appointments or as a wake-up.

Table 7 Apps (Continued)









Icon	Description
	Contacts - Use to manage contact information. See Contacts on page 69 for more information.
	DataWedge - Enables data capture using the imager.
	Device Central - Use to display detailed information about the device and connected peripherals. See Device Central on page 95 for more information.
	Diagnostic Tool - Use to diagnose the device.
	Drive - Upload photos, videos, documents, and other files to personal storage site. GMS/GMS-Restricted only.
	DWDemo - Provides a way to demonstrate the data capture features using the imager. See DataWedge Demonstration on page 98 for more information.
	Email - Use to send and receive email. AOSP only.
	Files - Organize and manage files on the device. See Files on page 81 for more information.
	Gallery - Use to view photos stored on the microSD card. For more information, see Gallery on page 82 for more information. AOSP only.
	Gmail - Use to send and receive email using a Google email account. GMS/GMS-Restricted only.
	Google - Launches Google search app. GMS/GMS-Restricted only.
	Hangouts - Use to communicate with friends using text messages and photos. GMS/GMS-Restricted only.
	Keep - Use to create, edit, and share notes. GMS/GMS-Restricted only.
	License Manager - Use to manage software licenses on the device.

Table 7 Apps (Continued)

Icon	Description
	Maps - Use to see your location on a map (with public transit, traffic, or satellite overlays). Search for any business or place of interest. Provides turn-by-turn navigation with voice guidance, traffic-avoidance, and alternate routes, for drivers, cyclists, walkers, and users of public transportation. GMS/GMS-Restricted only.
	Music - Play music stored on the microSD card. AOSP only.
	Phone - Use to dial a phone number when used with some Voice over IP (VoIP) clients (VoIP telephony ready only).
	Photos - Use to sync photos with Google account. For more information, see Photos on page 89 for more information. GMS/GMS-Restricted only.
	Play Movies & TV - View movies and video on your device. GMS/GMS-Restricted only.
	Play Music - Use to listen to music. GMS/GMS-Restricted only.
	Play Store - Download music, movies, books, and Android apps and games from the Google Play Store. GMS/GMS-Restricted only.
	PTT Express - Use to launch PTT Express client for VoIP communication.
	RxLogger - Use to diagnose device and app issues. See the device Integrator Guide for Android Version 8.1 for more information.
	RxLogger Utility - Use to view, backup, and archive RxLogger data.
	Search - Use to search the Web. Requires an Internet connection. AOSP only.
	Settings - Use to configure the device.
	SimulScan Demo - Use to demonstrate the document capture feature of the device.
	Sound Recorder - Use to record audio.

Table 7 Apps (Continued)

Icon	Description
	StageNow - Allows the device to stage a device for initial use by initiating the deployment of settings, firmware, and software.
	Worry Free Wifi Analyzer - A diagnostic intelligent app. Use to diagnose surrounding area and display network stats, such as coverage hole detection, or AP in vicinity. Refer to the Worry Free Wi-Fi Analyzer Administrator Guide for Android.
	YouTube - Use to view videos on the YouTube web site. GMS/GMS-Restricted only.
	Zebra Bluetooth - Use to configure Bluetooth logging.

Accessing Apps

All apps installed on the device are accessed using the **APPS** window.

1. On the Home screen, swipe up from the bottom of the screen.

Figure 30 APPS Window Example

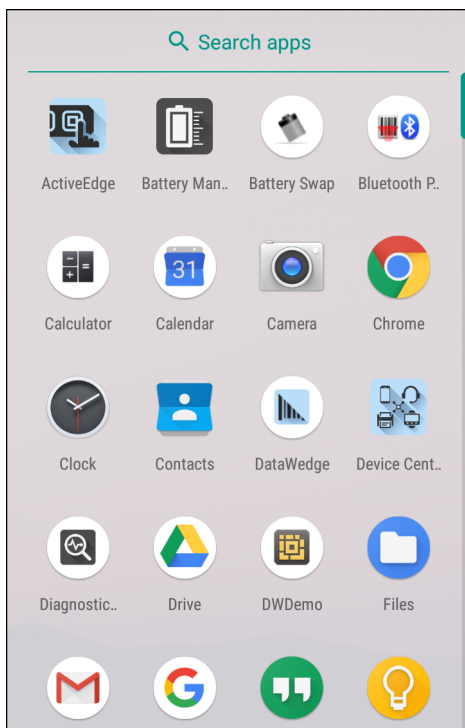

2. Slide the **APPS** window up or down to view more app icons. Touch an icon to open the app.

Switching Between Recent Apps

To switch between recent apps:



1. Touch . A window appears on the screen with icons of recently used apps.

Figure 31 Recently Used Apps

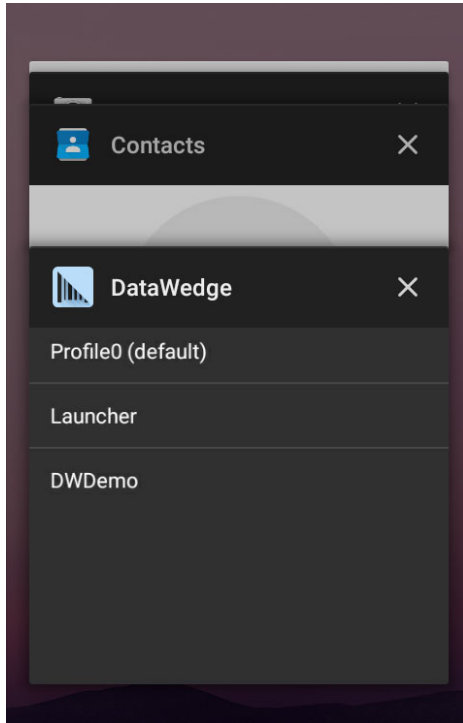

2. Slide the window up and down to view all recently used apps.
3. Swipe left or right to remove app from the list and force close the app.
4. Touch an icon to open it or touch  to return to the current screen.

Un-Locking the Screen

Use the Lock screen to protect access to data on the device. Some email accounts require locking the screen. Refer to the device Integrator Guide for Android Version 8.1 for information on setting up the locking feature.

When locked, a pattern, PIN, or password is required to unlock the device. Press the Power button to lock the screen. The device also locks after a pre-defined time-out.

Press and release the Power button to wake the device. The Lock screen displays. Swipe the screen up to unlock. If the Pattern screen unlock feature is enabled, the Pattern screen appears instead of the Lock screen. If the PIN or Password screen unlock feature is enabled, enter the PIN or password after unlocking the screen.

Figure 32 Lock Screen

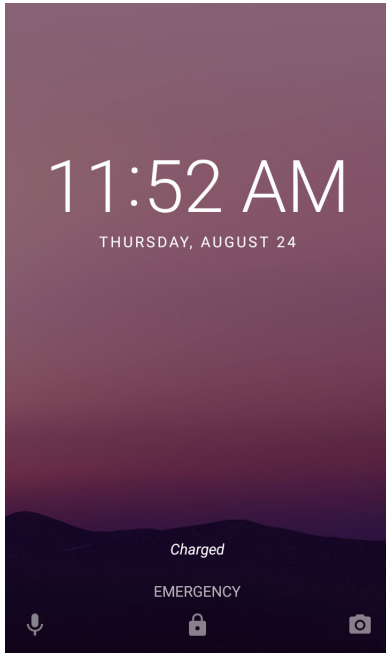

Figure 33 PIN Screen

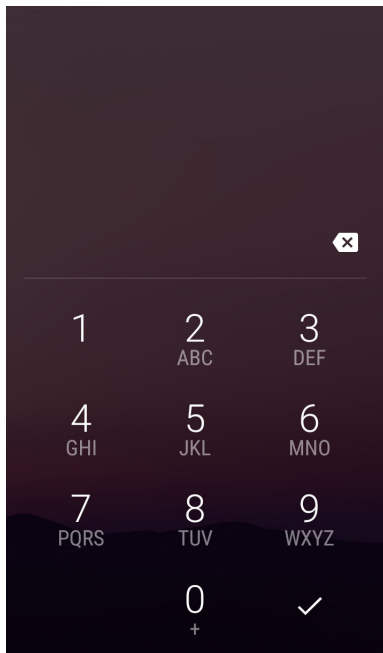

Figure 34 Pattern Screen

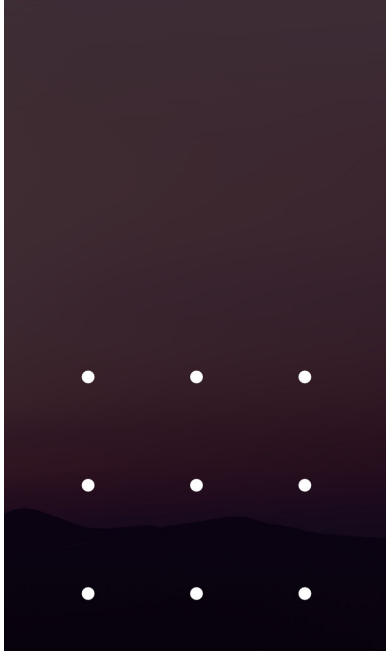
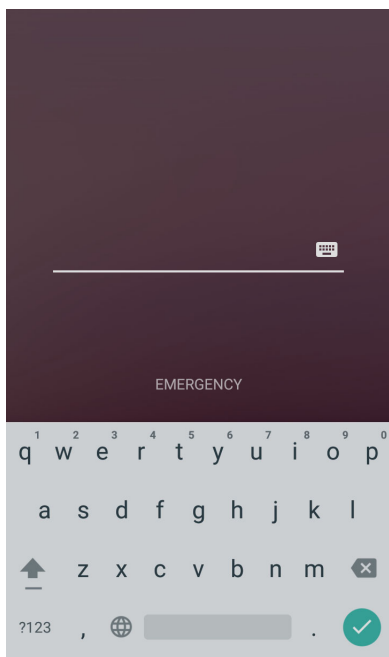



Figure 35 Password Screen



Smart Lock

Keep the device unlocked in some situations, like when the device is in your pocket or near a specific location. With Smart Lock, the user will not need to unlock the device with a PIN, pattern, or password.

To enable Smart Lock:

1. Ensure that a screen lock feature (PIN, pattern, or password) is enabled.
2. Swipe down from the Status bar to open the Quick Settings bar and then touch .

3. Touch **Security & location > Smart Lock**.
4. Enter the PIN, pattern, or password to continue.

Figure 36 Smart Lock Screen

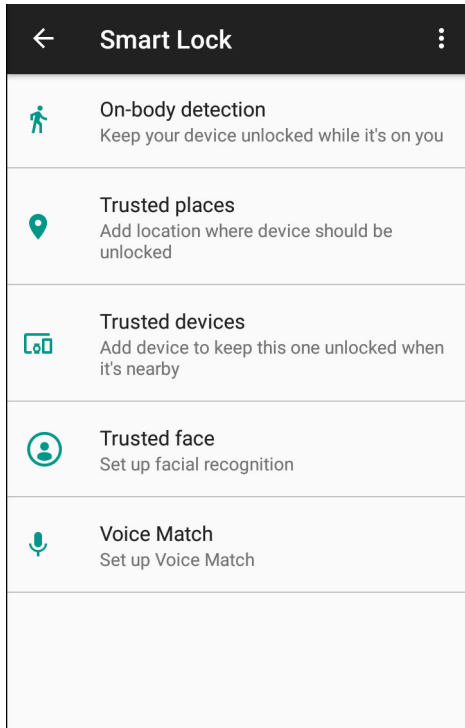

5. Select one of the options:
 - **On-body detection**
 - **Trusted places**
 - **Trusted devices**
 - **Trusted face**
 - **Voice Match.**
6. Follow the on-screen instructions for setting up each option.

Resetting the Device

There are two reset functions, soft reset and hard reset.

Performing a Soft Reset

Perform a soft reset if applications stop responding.

1. Press and hold the Power button until the menu appears.
2. Touch **Restart**.
3. The device reboots.

Performing a Hard Reset



CAUTION: Performing a hard reset with a microSD card installed in the device may cause damage or data corruption to the microSD card.

Perform a hard reset if the device stops responding.

1. Simultaneously press the Power, PTT and Volume Up buttons for at least four seconds.
2. When the screen turns off, release the buttons.
3. The device reboots.

Suspend Mode

The device goes into suspend mode when the user presses the Power button or after a period of inactivity (set in the Display settings window).

To wake the device from Suspend mode, press the Power button. The Lock screen displays. Swipe the screen up to unlock. If the Pattern screen unlock feature is enabled, the Pattern screen appears instead of the Lock screen. If the PIN or Password screen unlock feature is enabled, enter the PIN or password after unlocking the screen. See [Un-Locking the Screen on page 53](#).



NOTE: If the user enters the PIN, password, or pattern incorrectly five times, they must wait 30 seconds before trying again. If the user forgets the PIN, password, or pattern contact the system administrator.

Transferring Files with a Host Computer via USB

Connect the device to a host computer using a USB cable or a USB cradle to transfer files between the device and the host computer.

When connecting the device to a host computer, follow the host computer's instructions for connecting and disconnecting USB devices, to avoid damaging or corrupting files.

Transferring Files



NOTE: Use Transfer files to copy files between the device (internal memory or microSD card) and the host computer.

1. Connect a USB cable to the device or place the device into a USB cradle.

2. Pull down the Notification panel and touch **USB charging this device**.
By default, **Charge this device** is selected.

Figure 37 Use USB to Dialog Box

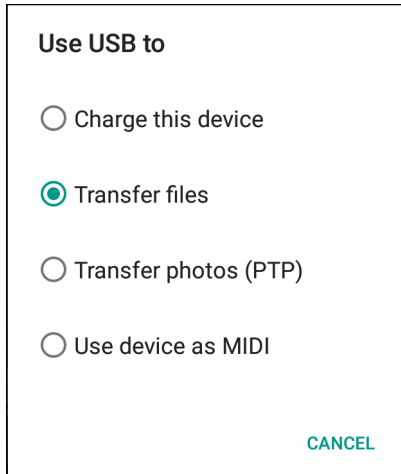

3. Touch **Transfer files**.

 **NOTE:** After you change the setting to **Transfer files**, and then disconnect the USB cable, the setting reverts back to **Charge this device**. If the USB cable is reconnected, select **Transfer files** again.

4. On the host computer, open a file explorer application.
5. Locate the **device** as a portable device.
6. Open the **SD card** or the **Internal storage** folder.
7. Copy files to and from the device or delete files as required.

Transferring Photos

To transfer photos using Photo Transfer Protocol:

 **NOTE:** Use Photo Transfer Protocol (PTP) to copy photos from either the microSD card or internal memory to the host computer.

1. Connect USB cable to the device or place the device into a USB cradle. See [Accessories](#) for setup information.
2. Pull down the Notification panel and touch **USB charging this device**.
3. Touch **Transfer photos (PTP)**.
4. On the host computer, open a file explorer application.
5. Open the **SD card** or the **Internal storage** folder.
6. Copy or delete photos as required.

Disconnect from the Host Computer

To disconnect the device from the host computer:

 **CAUTION:** Carefully follow the host computer's instructions to unmount the microSD card and disconnect USB devices correctly

to avoid losing information.

1. On the host computer, unmount the device.
2. Remove the USB from the device or remove the device from the cradle.

Applications

Introduction

This section describes the applications installed on the device.

ActiveEdge Touch Zone

The **ActiveEdge Touch Zone** app provides configurable settings which enable quick and convenient one-touch access to key features or apps while using other apps.



NOTE: The **ActiveEdge Touch Zone** is only available when the display is set to Portrait mode.

Configuring ActiveEdge

Figure 38 ActiveEdge App Settings

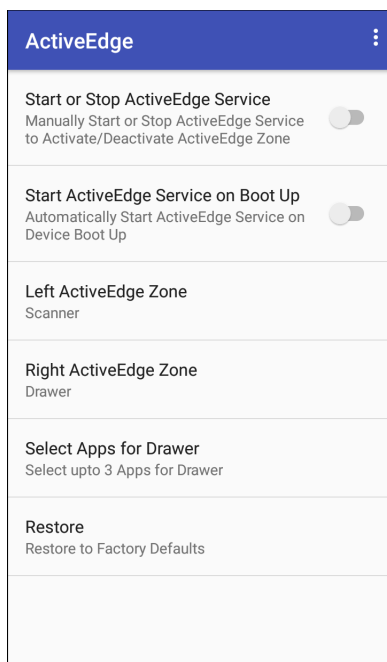

To configure ActiveEdge, swipe up from the bottom of the Home screen and touch

- **Start or Stop ActiveEdge Service** - Touch to start/stop the ActiveEdge service to enable/disable the ActiveEdge Zone.
- **Start ActiveEdge Service on Boot Up** - Automatically start the ActiveEdge service when the device boots up. The service is always running and available.
- **Left ActiveEdge Zone** - Configure the left ActiveEdge Zone to **Scanner**, **Drawer**, or **None**.
- **Right ActiveEdge Zone** - Configure the right ActiveEdge Zone to **Scanner**, **Drawer**, or **None**.

Figure 39 Left and Right ActiveEdge Zones

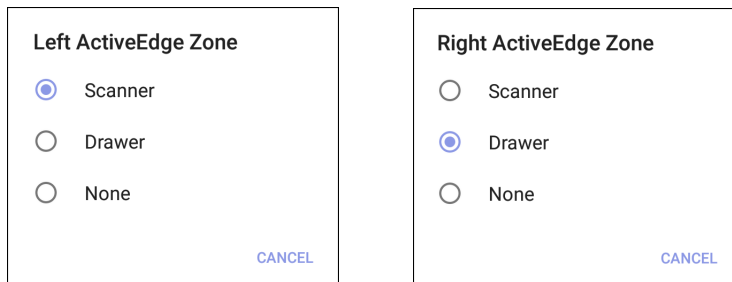

- **Select Apps for Drawer** - Select up to three apps to appear in the drawer. See Selecting Apps for a Drawer.
- **Restore** - Restore the settings to the factory defaults.
- **About ActiveEdge** - Open the **About ActiveEdge** window to display the version number. Select **⋮ > About**.

Selecting Apps for a Drawer

When the **Left ActiveEdge Zone** or the **Right ActiveEdge Zone** is set to **Drawer**, select up to three apps to display in the drawer.

To select which apps display in the drawer:

1. Touch **Select Apps for Drawer**.

Figure 40 Select Apps for Drawer

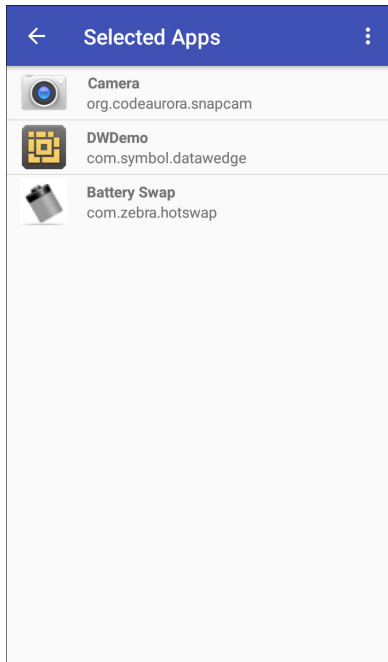

2. Touch **☰ > Select Apps**.

Figure 41 Select Apps for Drawer

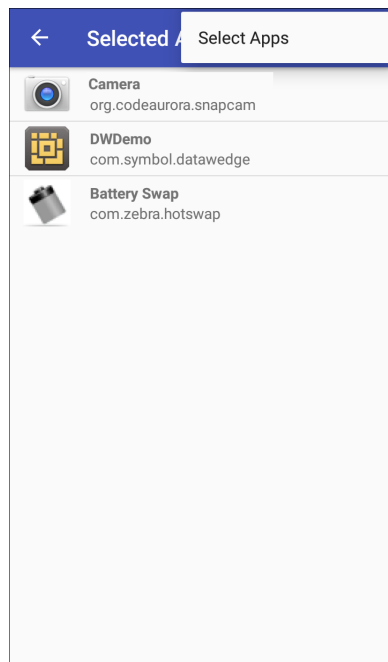

3. Choose up to three apps to appear in the **Drawer**.



NOTE: Configure the **Left ActiveEdge Zone** and the **Right ActiveEdge Zone** to any combination of **Scanner**,

Drawer, or **None**, except that both zones cannot be set to **Drawer**.

Figure 42 Select Apps for Drawer

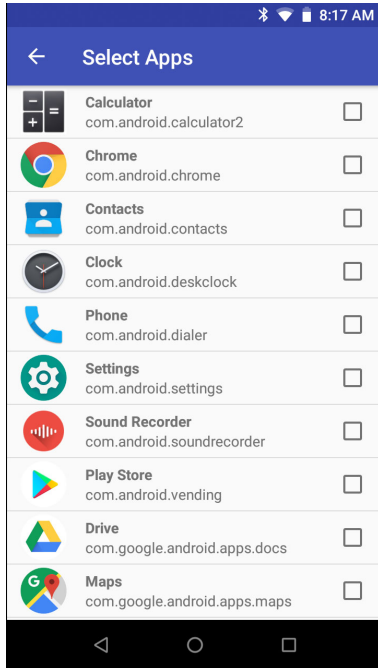

4. Touch .

Using ActiveEdge

Once configured, soft keys near the perimeter of the display provide access to those frequently used apps or tasks.

Figure 43 ActiveEdge Touch Zone Soft Key

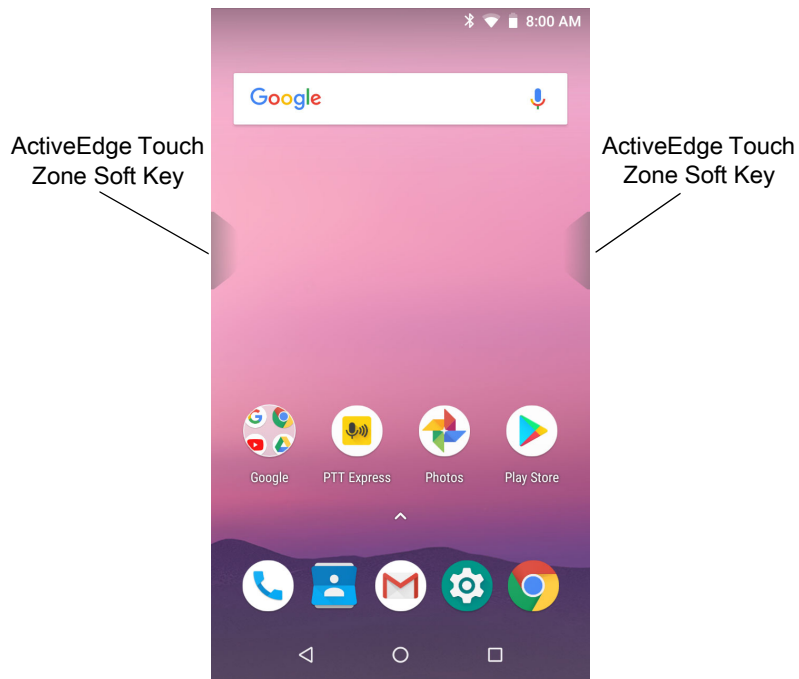

When a soft key is set to Scanner, touch and hold the soft key to scan a barcode.

Figure 44 Left ActiveEdge Zone set to Scanner

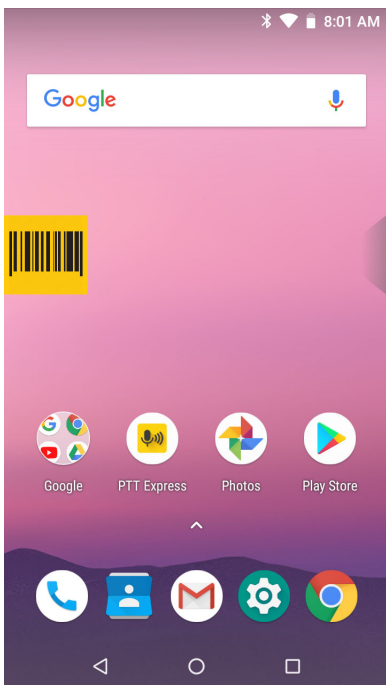

When a soft key is set to **Drawer**, touch the soft key to open the drawer and then select an app.

Figure 45 Right ActiveEdge Zone set to Drawer

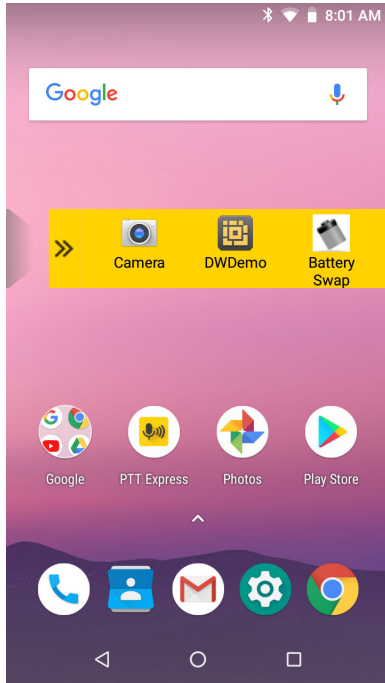

When the app is selected, the drawer automatically closes.

Battery Manager

The **Battery Manager** provides detailed information about the battery.

To open Battery Manager, swipe up from the bottom of the Home screen and touch .

Figure 46 Battery Manager Screen

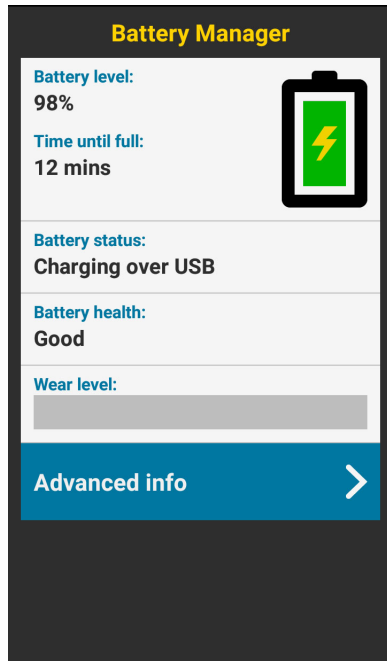





Table 8 Battery Icon Description

Battery Icon	Description
	Battery charge level.
	Battery charging.
	Battery charge level is below 20%.

- **Battery level** - The current battery charge level as a percentage. Displays -% when level is unknown.
- **Time until full** - The amount of time until the battery is fully charged.
- **Time since charging** - The amount of time since the device began charging.
- **Time until empty** - The amount of time until the battery is empty.

- **Battery status**
 - **Not charging** - The device is not connected to AC power.
 - **Charging over AC** - The device is connected to AC power and charging.
 - **Charging over USB** - The device is connected to a host computer with a USB cable and charging.
 - **Discharging** - That the battery is discharging.
 - **Full** - That the battery is fully charged.
 - **Unknown** - The battery status is unknown.
- **Battery health** - The health of the battery. If a critical error occurs,  appears. Touch to view the error description.
 - **Decommission** - The battery is past its useful life and should be replaced. See system administrator.
 - **Good** - The battery is good.
 - **Charge error** - An error occurred while charging. See system administrator.
 - **Over Current** - An over-current condition occurred. See system administrator.
 - **Dead** - The battery has no charge. Replace the battery.
 - **Over Voltage** - An over-voltage condition occurred. See system administrator.
 - **Below Temperature** - The battery temperature is below the operating temperature. See system administrator.
 - **Failure Detected** - A failure has been detected in the battery. See system administrator.
 - **Unknown** - See system administrator.
- **Wear level** - The health of the battery in graphical form. When the wear level exceeds 80%, the bar color changes to red.
- **Advanced info** - Touch to view additional battery information.
 - **Battery present status** - Indicates that the battery is present.
 - **Battery level** - The battery charge level as a percentage of scale.
 - **Battery scale** - The battery scale level used to determine battery level (100).
 - **Battery voltage** - The current battery voltage in millivolts.
 - **Battery temperature** - The current battery temperature in degrees Centigrade.
 - **Battery technology** - The type of battery.
 - **Battery current** - The average current into or out of the battery over the last second in mAh.
 - **Battery manufacture date** - The date of manufacture.
 - **Battery serial number** - The battery serial number. The number matches the serial number printed on the battery label.
 - **Battery part number** - The battery part number.
 - **Battery rated capacity** - Lists the rated capacity of the backup battery in mAh.
 - **Battery decommission status** - Indicates if the battery is past its life span.
 - **Battery Good** - The battery is in good health.

- **Decommissioned Battery** - The battery is past its useful life and should be replaced.
- **Base cumulative charge** - Cumulative charge using Zebra charging equipment only.
- **Battery present capacity** - Maximum amount of charge that could be pulled from the battery under the present discharge conditions if the battery were fully charged.
- **Battery health percentage** - With a range from **0** to **100**, this is the ratio of “present_capacity” to “design_capacity” at a discharge rate of “design_capacity”.
- **% decommission threshold** - The default % decommission threshold for a gifted battery as 80%.
- **Battery present charge** - Amount of usable charge remaining in the battery at present under the current discharge conditions.
- **Battery total cumulative charge** - The total accumulated charge in all chargers.
- **Battery time since first use** - The time passed since the battery was placed in a Zebra terminal for the first time.
- **Battery error status** - The error status of the battery.
- **App version** - The application version number.

Contacts

Use the **Contacts** app to manage contacts.

From a Home or Apps screen, touch **Contacts** to open to the main list of contacts. Contacts are listed in alphabetical order. Swipe up or down to scroll through the list.

Adding a Contact

1. In the **Contacts** app, touch .
2. If there are more than one account with contacts, touch the one to use.
3. Type the contact's name and other information. Touch a field to start typing, and swipe down to view all categories.
4. To open a menu with preset labels, such as Home or Work for an email address, touch the label to the right of the item of contact information. Or, to create your own label, touch **Custom** in the menu.
5. Touch the check mark next to **Add New Contact**.

Editing Contacts

1. In the **Contacts** app, touch a contact name to edit.
2. Touch .
3. Edit the contact information.
4. Touch **SAVE**.

Deleting Contacts

1. In the **Contacts** app, touch a contact name to delete.
2. Touch .
3. Touch **Delete**.
4. Touch **DELETE** to confirm.

Camera

This section provides information for taking photos and recording videos using the integrated digital cameras.



The device saves photos and videos on the microSD card, if installed and the storage path is changed manually. By default, or if a microSD card is not installed, the device saves photos and videos on the internal storage.

Taking Photos





NOTE: See [Photo Settings on page 72](#) for camera setting descriptions.

1. Swipe up from the bottom of the Home screen and touch **Camera**.

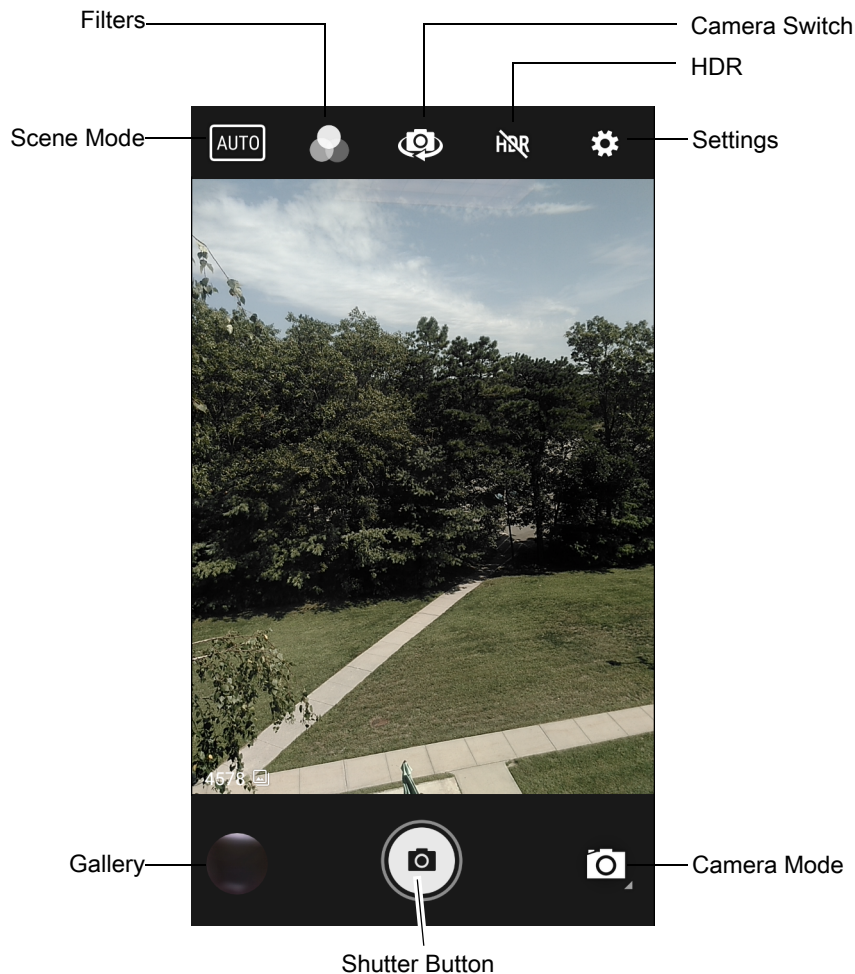
Figure 47 Camera Mode



2. If necessary, touch the Camera Mode icon and touch .
3. To switch between the rear camera and front camera, touch .
4. Frame the subject on the screen.
5. To zoom in or out, press two fingers on the display and pinch or expand fingers. The zoom controls appear on the screen.

6. Touch an area on the screen to focus. The focus circle appears. The two bars turn green when in focus.
7. Touch .
 - The camera takes a photo and a shutter sound plays.
 - The photo momentarily displays as a thumbnail in the lower left corner.



Taking a Panoramic Photo

Panorama mode creates a single wide image by panning slowly across a scene.

1. Swipe up from the bottom of the Home screen and touch **Camera**.

Figure 48 Panoramic Mode



2. Touch the Camera Mode icon and touch .
3. Frame one side of the scene to capture.
4. Touch  and slowly pan across the area to capture. A small white square appears inside the button indicating the capture is in progress.
 - If panning too quickly, the message **Too fast** appears.
5. Touch  to end the shot. The panorama appears immediately and a progress indicator displays while it saves the image.

Recording Videos

1. Swipe up from the bottom of the Home screen and touch **Camera**.

2. Touch the camera mode menu and touch .

Figure 49 Video Mode

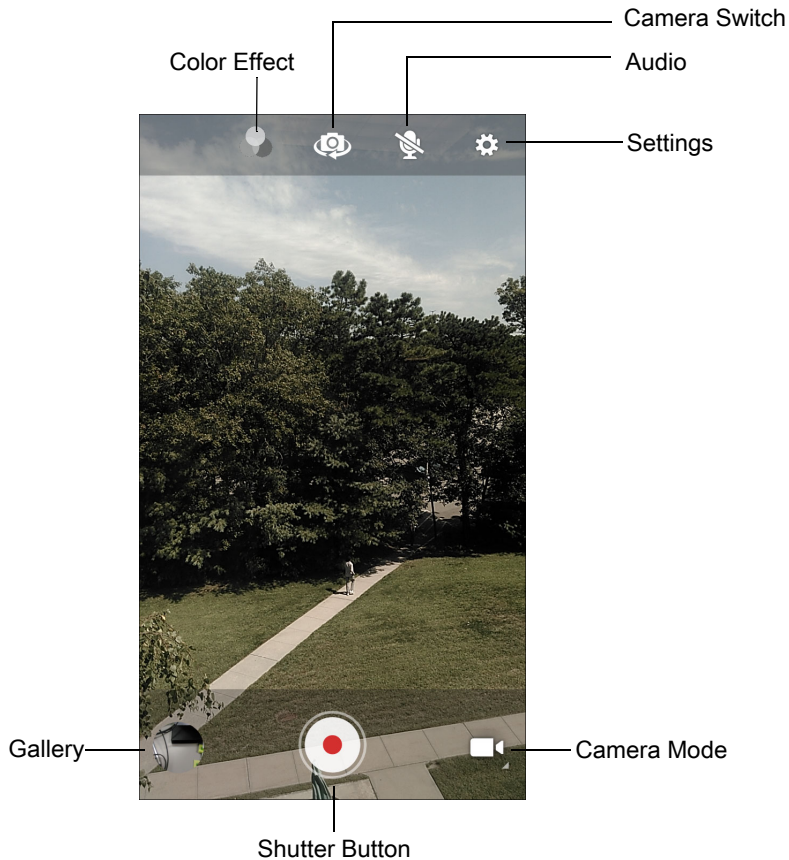









3. To switch between the rear camera and front camera (if available), touch .
4. Point the camera and frame the scene.
5. To zoom in or out, press two fingers on the display and pinch or expand fingers. The zoom controls appear on the screen.
6. Touch  to start recording.
The video time remaining appears in the top left of the screen.
7. Touch  to the end recording.
The video momentarily displays as a thumbnail in the lower left corner.

Photo Settings





In Photo mode, photo settings appear on screen. Touch  to display the photo settings options.





Front Camera

- **Selfie Flash** - Turns screen white to help produce a little extra light in dimmer settings. Options: **Off** (default), or **On**.

- **Picture size** - Set the size (in pixels) of the photo to: **5M pixels** (default), **3M pixels**, **HD1080**, **2M pixels**, **HD720**, **1M pixels**, **WVGA**, **VGA**, or **QVGA**.
- **Picture quality** - Set picture quality setting to: **Low**, **Standard** (default) or **High**.
- **Countdown timer** - Set to: **Off** (default), **2 seconds**, **5 seconds** or **10 seconds**.
- **Storage** – Set location to store the photo to: **Phone** or **SD Card**.
- **Face Detection** - Select to turn face detection **Off** (default) or **On**.
- **ISO** - Set how sensitive the camera is to light. Options: **Auto** (default), **ISO Auto (HJR)**, **ISO100**, **ISO200**, **ISO400**, **ISO800** or **ISO1600**.
- **Exposure** - Touch to adjust the exposure settings. Options: **+2**, **+1**, **0** (default), **-1** or **-2**.
- **White balance** - Select how the camera adjusts colors in different kinds of light, to achieve the most natural-looking colors:
 -  **Incandescent** - Adjust the white balance for incandescent lighting.
 -  **Fluorescent** - Adjust the white balance for florescent lighting.
 -  **Auto** - Adjust the white balance automatically (default).
 -  **Daylight** - Adjust the white balance for daylight.
 -  **Cloudy** - Adjust the white balance for a cloudy environment.
- **Redeye reduction** - Helps eliminate redeye effect. Options: **Disabled** (default), or **Enable**.
- **ZSL** - Set the camera to immediately take a picture when the button is pressed (default – enabled)
- **Selfie Mirror** - Options: **Disable** (default), or **Enable**.
- **Anti Banding** - Allows the camera to avoid problems caused by artificial light sources that are not constant. These sources cycle (flicker) fast enough to go unnoticed to the human eye, appearing continuous. The camera's eye (its sensor) can still see this flicker. Options: **Auto** (default), **60 Hz**, **50 Hz**, or **Off**.

Rear Camera





- **Flash** - Select whether the camera relies on its light meter to decide whether a flash is necessary, or to turn it on or off for all shots.
 -  **Off** - Disable flash.
 -  **Auto** - Adjust flash automatically depending upon light meter (default).
 -  **On** - Enable flash upon taking a photo.
 -  **Torch** - Turn flash on continuously.
- **Picture size** - The size (in pixels) of the photo to: **13M pixels** (default), **8M pixels**, **5M pixels**, **3M pixels**, **HD 1080**, **2M pixels**, **HD720**, **1M pixels**, **WVGA**, **VGA** or **QVGA**.
- **Picture quality** - Set the picture quality setting to: **Low**, **Standard** (default) or **High**.
- **Countdown timer** - Select **Off** (default), **2 seconds**, **5 seconds** or **10 seconds**.
- **Storage** – Set the location to store the photo to: **Phone** or **SD Card**.
- **Face Detection** - Select to turn face detection **Off** (default) or **On**.
- **ISO** - Set camera sensitivity to light to: **Auto** (default), **ISO Auto (HJR)**, **ISO100**, **ISO200**, **ISO400**, **ISO800** or **ISO1600**.
- **Exposure** - Set the exposure settings to: **+2**, **+1**, **0**(default), **-1** or **-2**.

- **White balance** - Select how the camera adjusts colors in different kinds of light, to achieve the most natural-looking colors:
 -  **Incandescent** - Adjust the white balance for incandescent lighting.
 -  **Fluorescent** - Adjust the white balance for florescent lighting.
 -  **Auto** - Adjust the white balance automatically (default).
 -  **Daylight** - Adjust the white balance for daylight.
 -  **Cloudy** - Adjust the white balance for a cloudy environment.
- **Chroma Flash** - Sets the camera to take two pictures, one with flash and one without flash. The two images are combined to produce a final image with the sharpness and clarity and bright color tones from a picture with the flash, coupled with the natural colors of a picture without a flash. Options: **Off** (default) or **On**.
- **Redeye reduction** - Helps eliminate redeye effect. Options: **Disabled** (default), or **Enable**.
- **ZSL** - Set the camera to immediately take a picture when the button is pressed (default – enabled).
- **Anti Banding** - Allows the camera to avoid problems caused by artificial light sources that are not constant. These sources cycle (flicker) fast enough to go unnoticed to the human eye, appearing continuous. The camera's eye (its sensor) can still see this flicker. Options: **Auto** (default), **60 Hz**, **50 Hz**, or **Off**.



Video Settings





In Video mode, video settings appear on screen. Touch  to display the video settings options.

Front Camera

- **Video quality** - Set video quality to: **HD1080** (default), **HD720**, or **SD 480p**.
- **Video duration** - Set to: **30 seconds (MMS)** or **30 minutes** (default).
- **Storage** – Set the location to store the photo to: **Phone** (default) or **SD Card**.
 - **White balance** - Select how the camera adjusts colors in different kinds of light, to achieve the most natural-looking colors:
 -  **Incandescent** - Adjust the white balance for incandescent lighting.
 -  **Fluorescent** - Adjust the white balance for florescent lighting.
 -  **Auto** - Adjust the white balance automatically (default).
 -  **Daylight** - Adjust the white balance for daylight.
 -  **Cloudy** - Adjust the white balance for a cloudy environment.
- **Image Stabilization** - Set to reduce blurry videos due to device movement. Options: **On** or **Off** (default).

Rear Camera

- **Flash** - Select whether Rear-facing Camera relies on its light meter to decide whether a flash is necessary, or to turn it on or off for all shots.
 -  **Off** - Disable flash (default).
 -  **Torch** - Turn flash on continuously.
- **Video quality** - Set video quality to: **HD 1080p** (default), **HD 720p**, or **SD 480p**.
- **Video duration** - Set to: **30 seconds (MMS)**, or **30 minutes** (default).

- **Storage** – Set the location to store the photo to: **Phone** (default) or **SD Card**.
- **White balance** - Select how the camera adjusts colors in different kinds of light, to achieve the most natural-looking colors.
 -  **Incandescent** - Adjust the white balance for incandescent lighting.
 -  **Fluorescent** - Adjust the white balance for florescent lighting.
 -  **Auto** - Adjust the white balance automatically (default).
 -  **Daylight** - Adjust the white balance for daylight.
 -  **Cloudy** - Adjust the white balance for a cloudy environment.
- **Image Stabilization** - Set to reduce blurry videos due to device movement. Options: **On** or **Off** (default).

Diagnostic Tool

The **Diagnostic Tool** is a utility that determines the health of the device. Use the Diagnostic Tool to troubleshoot the device.

1. Swipe up from the bottom of the Home screen and touch .

Figure 50 Diagnostic Tool



2. Touch **RUN TEST**. The app tests all enabled subsystems (by default, only the Battery and System tests). See [Settings on page 79](#) to enable subsystem tests.

Figure 51 Test Passed Screen

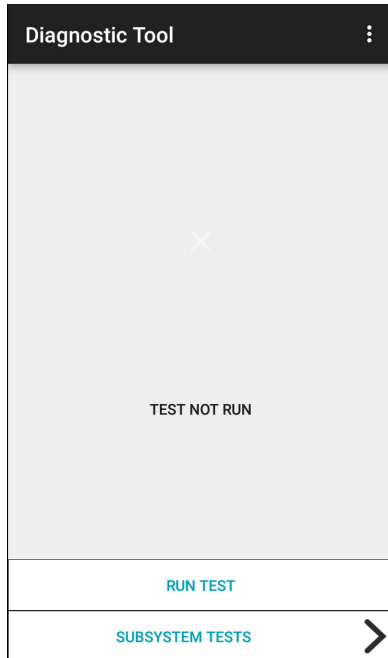
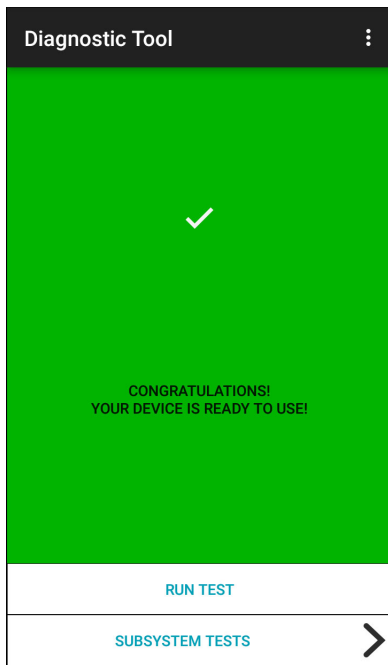
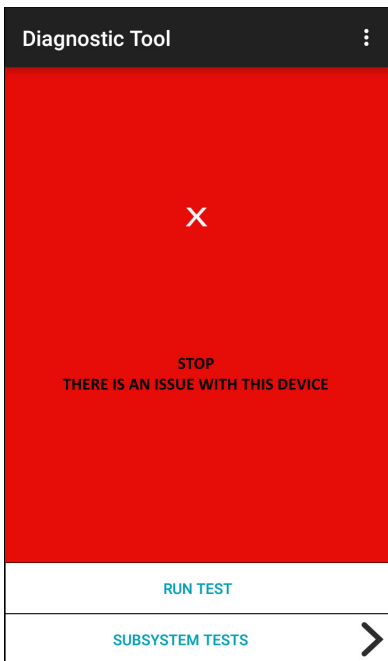

Figure 52 Test Failed Screen



3. To view each subsystem test, touch **Subsystem Tests**.

Figure 53 Subsystem Screen

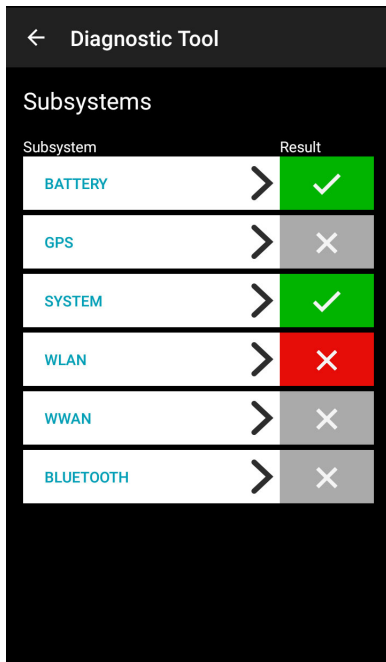



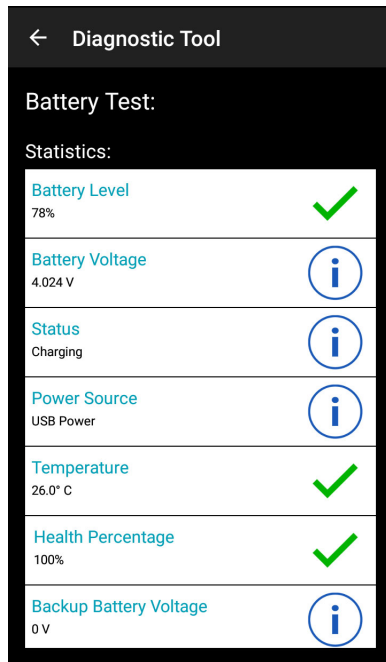

Table 9 Subsystem Test Result Indicators

Status Icon	Description
	Test passed.
	Test failed.
	Test not supported or not enabled.

4. Touch one of the subsystems to view details.

Figure 54 Battery Subsystem Details



Settings

By default only the Battery and System tests are enabled. To enable other tests:

1. Touch **☰** > **Settings**.
2. Touch to the left of the test name. A green box with a checkmark appears.
3. Touch **SAVE**.
4. Touch **Yes** to confirm.
5. Touch **◀**.

Battery Test Information

The Battery Test obtains the following information:

- **Battery Level** - Current battery charge level
- **Battery Voltage** - Current battery voltage
- **Status** - Whether the battery is charging (on AC power) or discharging (on battery power)
- **Power Source** - Whether the device is receiving power from the battery or from an external source
- **Temperature** - Current battery temperature
- **Health Percentage** - Indicates the ratio of present capacity to design capacity at a discharge rate of design capacity.
- **Backup Battery Voltage** - Backup battery voltage
- **Manufacture Date** - Manufacture date of the battery.

GPS Test Information

Not supported on this device.

System Test Information

Use the System Test to determine if the CPU or memory loads are too high, there are too many processes running on the device, or storage on the device is almost full.

The System Test obtains the following information:

- **CPU Load** - Amount of CPU being used
- **Free Physical Memory** - Amount of RAM available
- **Free Storage** - Amount of internal Flash memory available
- **Process Count** - Number of processes currently running.

WLAN Test Information

If the WiFi radio is not present or disabled, skip this test. This test determines if the device's WLAN configuration is correct or whether there is any connection with an access point or network.

The WLAN test obtains the following information:

- **WLAN Enabled** - WLAN radio is enabled or disabled
- **WLAN Status** - Current status of association with the access point
- **ESSID** - Name of the wireless network
- **BSSID** - MAC address of the connected access point
- **MAC Address** - Device's MAC address
- **Signal** - Strength of the Wi-Fi signal (in dBm)
- **IP Address** - IP address of the device.

WWAN Test Information

Not supported on this device.

Bluetooth Test Information

The Bluetooth Test obtains the following information:

- **Enabled** - Whether the Bluetooth radio is enabled or disabled
- **Status** - Whether the device is paired to another Bluetooth device
- **Connectable/Discoverable** - Whether the device is discoverable or able to connect
- **Address** - Bluetooth radio MAC address
- **Name** - Bluetooth name for the device.

Files

Use the **Files** app to view and manage files on the device.







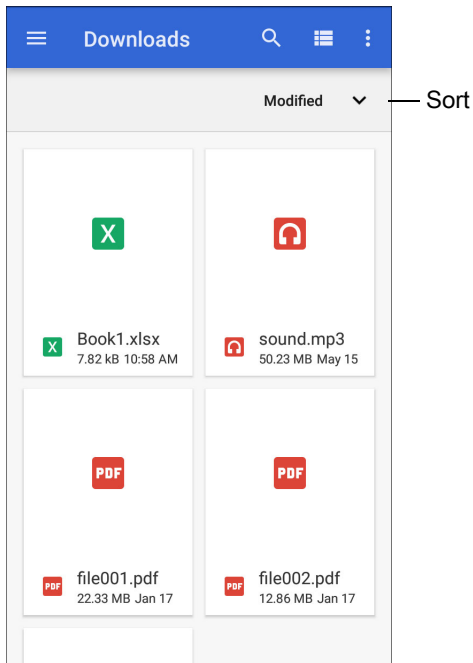

To open **Files**, swipe up from the bottom of the screen and touch .

Figure 55 Files Screen



- Touch and hold an item to open the File Operations menu. Select an option:
 -  - Share the file with other devices.
 -  - Delete the file.
 -  - View additional options.
 - **Open with** - Select which app is used to open the file.
 - **Select all** - Select all folders and files.
 - **Copy to...** - Copy the file.
 - **Move to...** - Move the file or folder to a new location.
 - **Compress** - Compress the selected file(s) into a ZIP file.
 - **Rename** - Rename the file.
- Touch the Sort drop-down to sort files by name, type, size, or date.
-  - View all file locations.
-  - Search for a specific file on the device.
-  /  - Change the folder to display items as a list / grid.
-  - Open the options menu.
 - **New Window** - Create a new Files window.
 - **New Folder** - Create a new folder.
 - **Select all** - Select all folders and files.
 - **Show/Hide internal storage** - Show or hide internal storage.

Gallery



NOTE: The device supports the following image formats: jpeg, gif, png and bmp.

The device supports the following video formats: H.263, H.264 and MPEG4 Simple Profile.

Available on device with AOSP only.

Use Gallery to:

- View photos
- Play videos
- Perform basic editing of photos
- Set photos as wallpaper
- Set photos as a contact photo
- Share photos and videos.

Gallery presents all photos and videos stored on the microSD card and internal memory.

To open **Gallery**, swipe up from the bottom of the Home screen and touch **Gallery**, or in the camera app touch the thumbnail image at the bottom left.

By default, **Gallery** opens to the **Timeline** view.

Figure 56 Gallery - Timeline View

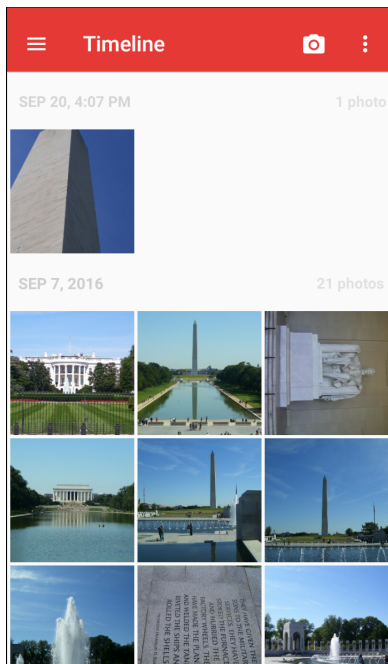





Touch  > **Albums** to view photos sorted by albums or  > **Videos** to view only videos.

Figure 57 Gallery — Albums View

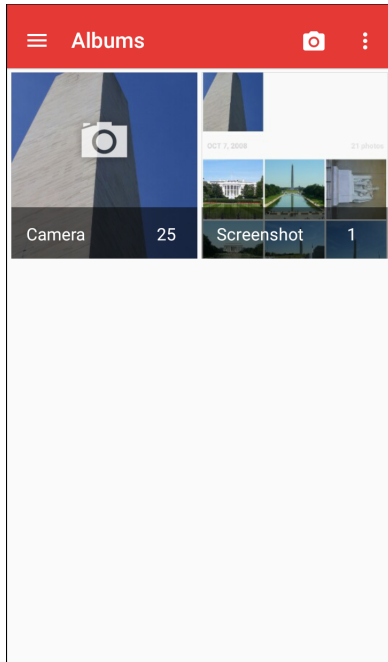

- Touch an album to open it and view its contents. The photos and videos in the album are displayed in chronological order.
- Touch a photo or video in an album to view it.
- Touch  > **Timeline** to return to the default **Gallery** screen.

Working with Albums

Albums are groups of images and videos in folders. Touch an album to open it. The photos and videos are listed in a chronologically ordered grid. The name of the album displays at the top of the screen.

Figure 58 Photos Inside an Album

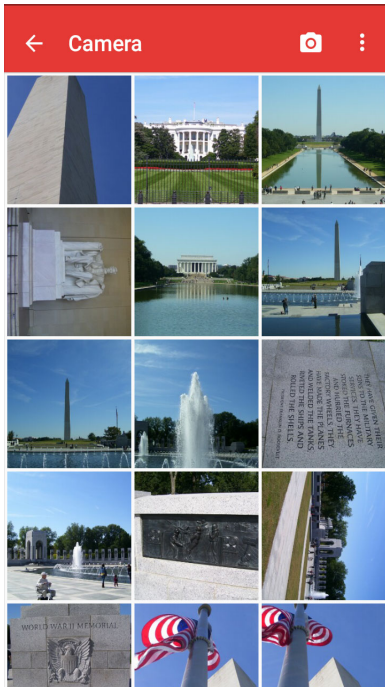

Swipe up or down to scroll through the images.

Sharing an Album

1. Swipe up from the bottom of the Home screen and touch **Gallery**.
2. Touch and hold an album to highlight it.
3. Touch other albums as required.
4. Touch . The Share menu opens.
5. Touch the app to use to share the selected albums.
6. Follow the instructions within the selected app.

Getting Album Information

1. Swipe up from the bottom of the Home screen and touch **Gallery**.
2. Touch and hold an album to highlight it.
3. Touch .
4. Touch **Details**.

Deleting an Album

To delete an album and its contents:

1. Swipe up from the bottom of the Home screen and touch **Gallery**.
2. Touch and hold an album to highlight it.
3. Check other albums to delete.
4. Touch .
5. In the **Delete selected item?** menu, touch **OK** to delete the album.

Working with Photos

Use **Gallery** to view photos on the device and edit and share photos.

Viewing and Browsing Photos

To view a photo:

1. Swipe up from the bottom of the Home screen and touch **Gallery**.
2. Touch an album to open it.
3. Touch a photo.

Figure 59 Photo Example

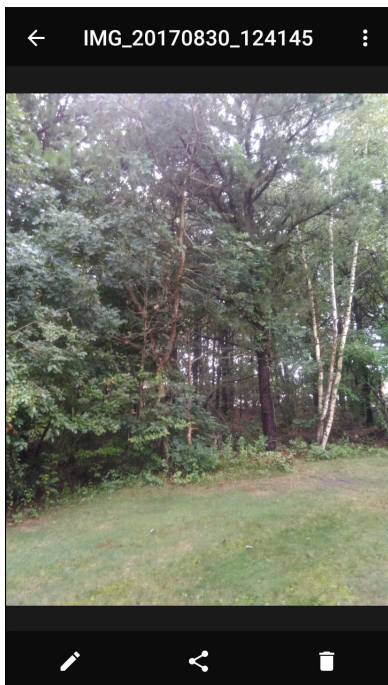

4. Swipe left or right to view the next or previous photo in the album.
5. Turn the device to view the photo in upright (portrait) or sideways (landscape) orientation. The photo is displayed (but not saved) in the new orientation.
6. Touch the photo to view the controls.

7. Double-tap the screen to zoom in or pinch two fingers together or spread them apart to zoom in or out.
8. Drag the photo to view parts that are not in view.

Cropping a Photo





1. In **Gallery**, touch a photo to view the controls.
2. Touch  >  > . The cropping tool appears.
3. Use the cropping tool to select the portion of the photo to crop.
 - Drag from the inside of the cropping tool to move it.
 - Drag an edge of the cropping tool to resize it to any proportion.

Figure 60 Cropping Tool

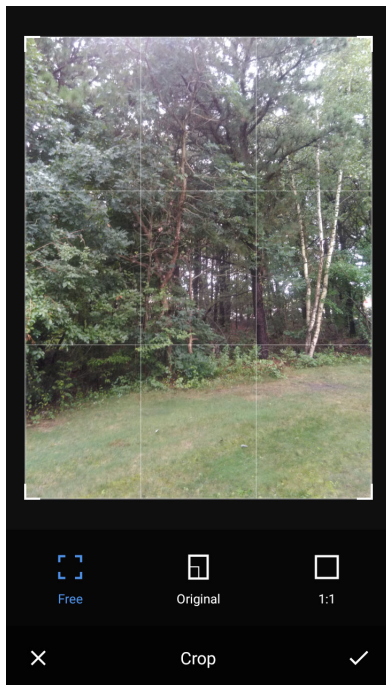

4. Touch  > **SAVE** to save a copy of the cropped photo. The original version is retained.

Setting a Photo as a Contact Icon

1. Swipe up from the bottom of the Home screen and touch **Gallery**.
2. Touch an album to open it.
3. Touch a photo to open it.
4. Touch .
5. Touch **Set picture as**.
6. Touch **Contact photo**.
7. In **Contacts**, touch a contact.
8. Touch the white box and crop the photo accordingly.

9. Touch **SAVE**.

Sharing a Photo

1. Swipe up from the bottom of the Home screen and touch **Gallery**.
2. Touch an album to open it.
3. Touch a photo to open it.
4. Touch .
5. Touch the app to use to share the selected photo.
6. Follow the instructions within the selected app.

Deleting a Photo

1. Swipe up from the bottom of the Home screen and touch **Gallery**.
2. Touch an album to open it.
3. Touch a photo to open it.
4. Touch .
5. Touch **OK** to delete the photo.

Working with Videos

Use **Gallery** to view and share videos.

Watching Videos

1. Swipe up from the bottom of the Home screen and touch **Gallery**.
2. Touch an album to open it.
3. Touch a video.
4. Touch  to play.
5. Touch the screen to view the playback controls.

Sharing a Video

1. Swipe up from the bottom of the Home screen and touch **Gallery**.
2. Touch an album to open it.
3. Touch a video to open it.
4. Touch . The Share menu appears.
5. Touch the app to use to share the selected video.
6. Follow the instructions within the selected app.

Deleting a Video

1. Swipe up from the bottom of the Home screen and touch **Gallery**.
2. Touch an album to open it.
3. Touch a video to open it.
4. Touch .
5. Touch **OK**.

Photos



NOTE: The device supports the following image formats: jpeg, gif, png, and bmp.

The device supports the following video formats: H.263, H.264, and MPEG4 Simple Profile.

Available on device with GMS only.

Use **Photos** to:

- View photos
- Play videos
- Perform basic editing of photos
- Set photos as wallpaper
- Set photos as a contact photo
- Share photos and videos.

Photos presents all photos and videos stored on the microSD card and internal memory.

To open **Photos**, swipe up from the bottom of the Home screen and touch **Photos**.

By default, **Photos** opens to the photos view.

Figure 61 Photos View

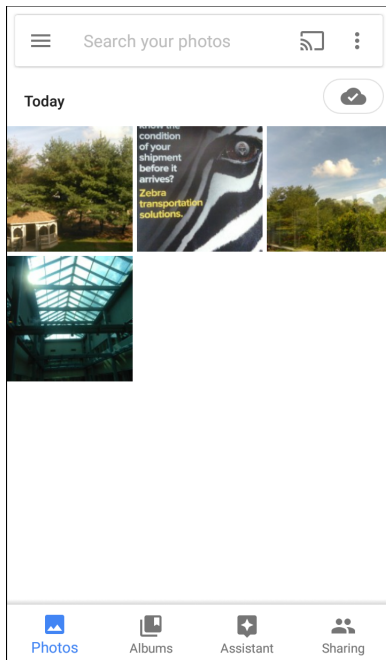

Touch **Albums** to view photos sorted by albums.

Figure 62 Albums View

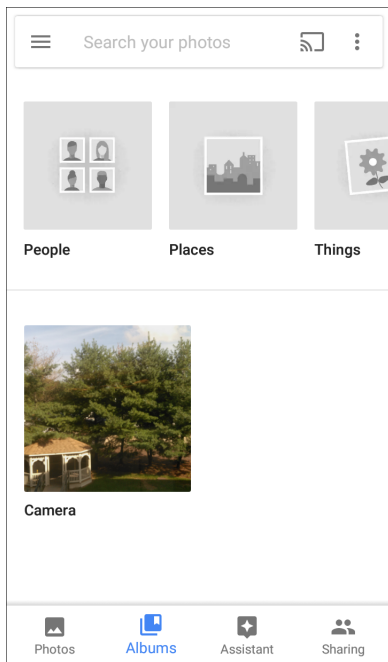

- Touch an album to view its contents. The photos and videos in the album appear in chronological order.
- Touch a photo or video in an album to view it.
- Touch **←** to return to the main screen.

Working with Albums

Albums are groups of images and videos in folders. Touch an album to open it. The photos and videos are listed in a chronologically ordered grid. The name of the album displays at the top of the screen.

Figure 63 Photos Inside an Album

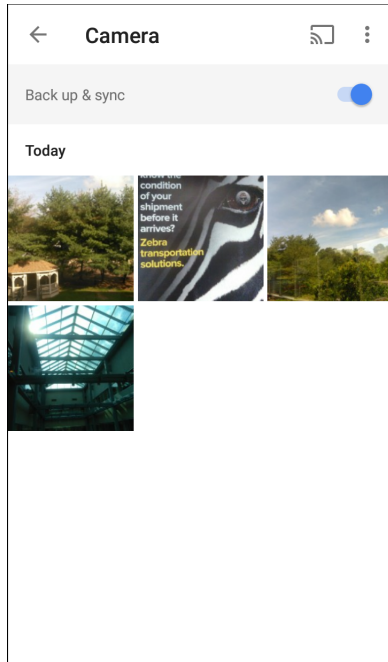

Swipe up to scroll through the images.

Sharing an Album

1. Swipe up from the bottom of the Home screen and touch **Photos**.
2. Touch **Albums**.
3. Touch an album.
4. Touch **⋮** > **Select**.
5. Select all photos in the album.
6. Touch **🔗**. The Share menu opens.
7. Touch an app to share the selected albums.
8. Follow the instructions within the selected app.

Deleting an Album

To delete an album and its contents:

1. Swipe up from the bottom of the Home screen and touch **Photos**.
2. Touch **Albums**.
3. Touch an album.

4. Touch **⋮** > **Select**.
5. Select all photos in the album.
6. Touch **🗑️**.
7. Touch **Move to trash** to delete the album.

Working with Photos

Use **Photos** to view photos on the internal memory and the microSD card.

Viewing and Browsing Photos

1. Swipe up from the bottom of the Home screen and touch **Photos**.
2. Touch a photo.

Figure 64 Photo Example

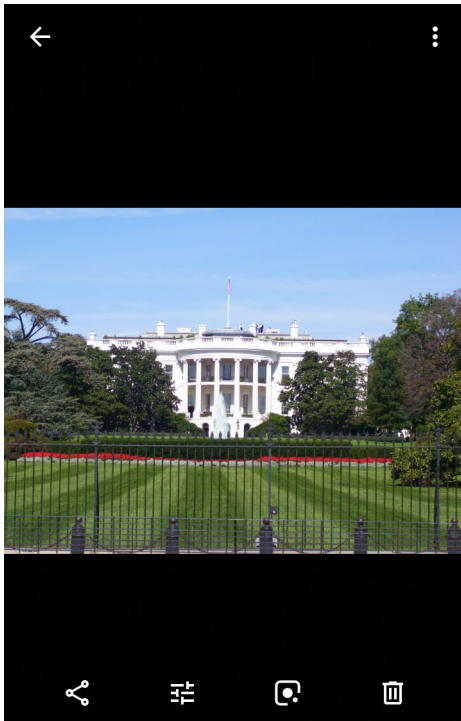

3. Swipe left or right to view the next or previous photo in the album.
4. Turn the device to view the photo in upright (portrait) or sideways (landscape) orientation. The photo is displayed (but not saved) in the new orientation.
5. Touch the photo to view the controls.
6. Double-tap the screen to zoom in, or pinch two fingers together or spread them apart to zoom in or out.
7. Drag the photo to view parts that are not in view.

Cropping a Photo

1. Swipe up from the bottom of the Home screen and touch **Photos**.



2. Touch a photo to view the controls.
3. Touch  > . The cropping tool appears.

Figure 65 Cropping Tool



4. Use the cropping tool to select the portion of the photo to crop.
 - Drag from the inside of the cropping area to move it.
 - Drag an edge of the cropping area to resize it to any proportion.
5. Touch **DONE**.
6. Touch **SAVE** to save a copy of the cropped photo. The original version is retained.

Setting a Photo as a Contact Icon

1. Swipe up from the bottom of the Home screen and touch **Photos**.
2. Touch the photo to open it.
3. Touch  > **Use as**.
4. Touch **Contact photo**.
5. In the **Contacts** app, touch a contact.
6. Touch the white box and crop the photo accordingly.
7. Touch **Done**.

Sharing a Photo

1. Swipe up from the bottom of the Home screen and touch **Photos**.

2. Touch an album to open it.
3. Touch a photo to open it.
4. Touch .
5. Touch the app to use to share the selected photo.
6. Follow the instructions within the selected app.

Deleting a Photo

1. Swipe up from the bottom of the Home screen and touch **Photos**.
2. Touch a photo to open it.
3. Touch .
4. Touch **MOVE TO TRASH**.

Working with Videos

Use **Photos** to view and share videos.

Watching a Video

1. Swipe up from the bottom of the Home screen and touch **Photos**.
2. Touch a video to play.
3. Touch the screen to view the playback controls.

Sharing a Video

1. Swipe up from the bottom of the Home screen and touch **Photos**.
2. Touch a video to open it.
3. Touch . The Share menu appears.
4. Touch the app to use to share the selected video.
5. Follow the instructions within the selected app.

Deleting a Video

1. Swipe up from the bottom of the Home screen and touch **Photos**.
2. Touch a video to open it.
3. Touch .
4. Touch **MOVE TO TRASH** to delete the video.

Device Central

Device Central displays detailed information about the device and connected peripherals and supports the following Zebra devices:

- RS507/RS507X Hands-free Imager
- RS6000 Bluetooth Ring Scanner
- RS5000 Corded Ring Scanner
- HS3100 Bluetooth Headset
- DS3678 Digital Scanner.

Device Central features include:

- Discovering and pairing with supported peripherals via Bluetooth or corded connection.
- Paging a connected RS6000 Ring Scanner.
- Updating the firmware of supported ring scanners. Refer to the RS5000 Quick Start Guide or RS6000 User Guide for more information.
- Displaying the connection status of peripherals.
- Displaying information for a connected peripheral in the notification bar.

Figure 66 Device Central Screen

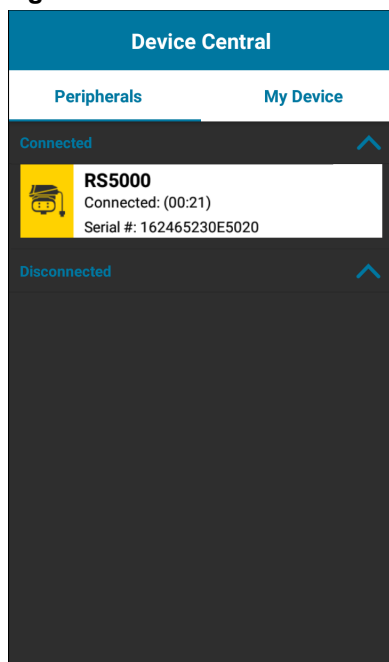

Device Central Tabs

- **Peripherals** Tab - displays all currently connected and previously connected peripherals. Connected peripherals display the length of time (in minutes) that they have been connected. When an RS6000 is connected the **Page** button displays. See [Paging an RS6000 Ring Scanner on page 96](#).

Touch the peripheral information to display the **Device Details** screen.

- **Device Details** - displays detailed device information for the selected peripheral.

- **My Device** Tab - displays information about the device and the current version of Device Central.
 - **Device Details** - displays the **Phone status** screen.
 - **Device Battery Details** - displays the **Battery** screen.

Figure 67 Page RS6000

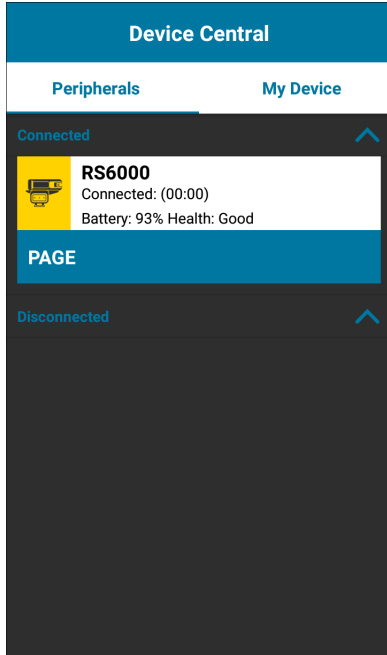

Paging an RS6000 Ring Scanner

Use **Page** to easily locate the connected RS6000 Ring Scanner:

1. With the RS6000 Ring Scanner connected, swipe up from the bottom of the screen and touch .



NOTE: The RS6000 Ring Scanner must be within 10 m (32 ft) of the device.

2. Under the RS6000 peripheral information, touch **Page to page the RS6000**. The paged RS6000 beeps and vibrates.

Figure 68 Page RS6000

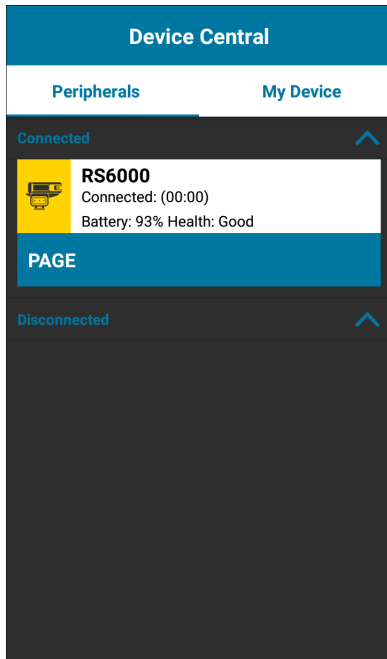

To stop paging, press the scan trigger of the RS6000. On a triggerless RS6000, reset the RS6000 to stop paging. Refer to the RS6000 User Guide.

DataWedge Demonstration



NOTE: DataWedge is disabled on the Home screen. To enable this feature, go to the DataWedge settings and enable Barcode input option.

Use **DataWedge Demonstration** to demonstrate data capture functionality.

Figure 69 DataWedge Demonstration Window

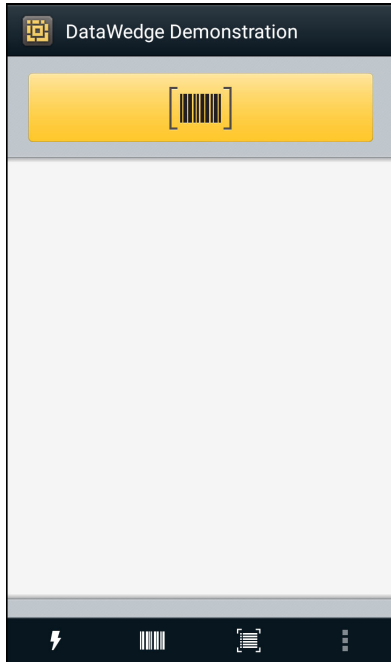





Table 10 DataWedge Demonstration Icons

	Icon	Description
Illumination		Imager illumination is on. Touch to turn illumination off.
		Imager illumination is off. Touch to turn illumination on.
Data Capture		The data capture function is through the internal imager.
		A Bluetooth scanner is connected.
		A Bluetooth scanner is not connected.
		The data capture function is through the rear camera.

Table 10 *DataWedge Demonstration Icons (Continued)*

	Icon	Description
Scan Mode		Imager is in picklist mode. Touch to change to normal scan mode.
		Imager is in normal scan mode. Touch to change to picklist mode.
		Opens a menu to view the application information or to set the application DataWedge profile.



NOTE: See the device Integrator Guide for Android Version 8.1 for information on DataWedge configuration.

Scanner Selection

To select a scanner, touch  > **Settings** > **Scanner selection**.

See [Data Capture](#) for more information.

Either press the programmable button or touch the yellow scan button to capture data. The data appears in the text field below the yellow button.

PTT Express Voice Client



NOTE: PTT Express Voice Client enables Push-To-Talk (PTT) communication between disparate enterprise devices. Leveraging existing Wireless Local Area Network (WLAN) infrastructure, PTT Express delivers simple PTT communication without requiring voice communication server.

- **Group Call:** Press and hold the PTT (Talk) button to start communicating with other voice client users.
- **Private Response:** Double-press the PTT button to respond to the originator of the last broadcast or to make a Private Response.

PTT Audible Indicators

The following tones provide helpful cues when using the voice client.

- **Talk Tone:** Double chirp. Plays when the Talk button is depressed. This is a prompt for the user to start talking.
- **Access Tone:** Single beep. Plays when another user just finished a broadcast or response. The user is now able to initiate a Group Broadcast or Private Response.
- **Busy Tone:** Continuous tone. Plays when the Talk button is depressed and another user is already communicating on the same talkgroup. Plays after the maximum allowed talk time is reached (60 seconds).
- **Network Tone:**
 - Three increasing pitch beeps. Plays when PTT Express acquires the WLAN connection and the service is enabled.
 - Three decreasing pitch beeps. Plays when PTT Express loses the WLAN connection or the service is disabled.



PTT Notification Icons

Notification icons indicate the current state of the PTT Express Voice client.

Table 11 *PTT Express Icon Descriptions*

Status Icon	Description
	The PTT Express Voice client is disabled.
	The PTT Express Voice client is enabled but not connected to a WLAN.
	The PTT Express Voice client is enabled, connected to a WLAN, and listening on the Talk Group indicated by the number next to the icon.
	The PTT Express Voice client is enabled, connected to a WLAN, and communicating on the Talk Group indicated by the number next to the icon.
	The PTT Express Voice client is enabled, connected to a WLAN, and in a private response.

Table 11 PTT Express Icon Descriptions (Continued)

Status Icon	Description
	The PTT Express Voice client is enabled and muted.
	The PTT Express Voice client is enabled but it is not able to communicate due to a VoIP telephony call in progress.

Enabling PTT Communication

1. Swipe up from the bottom of the Home screen and touch .
2. Slide the **Enable/Disable Switch** to the **ON** position. The button changes to **ON**.

Selecting a Talk Group

One of 32 Talk Groups can be selected by PTT Express users. However, only one talk group may be enabled at a time on the device. Touch one of the 32 Talk Groups. The selected Talk Group is highlighted.

PTT Communication



NOTE: This section describes the default PTT Express client configuration. Refer to the PTT Express V1.2 User Guide for detailed information on using the client.

PTT communication may be established as a Group Call. When PTT Express is enabled, the PTT button on the left side of the device is assigned for PTT communication. When the Wired Headset is used, Group Calls can also be initiated using the headset Talk button.



NOTE: When using a wired headset, use only Zebra wired headsets with a PTT button.

Figure 70 PTT Button

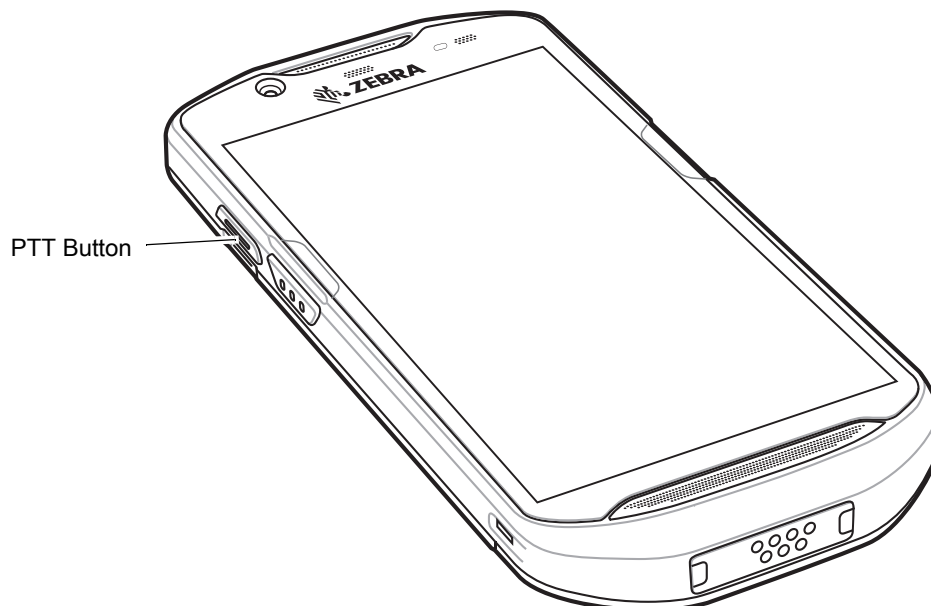

Creating a Group Call



NOTE: When using a wired headset, use only Zebra wired headsets with a PTT button.

1. Press and hold the PTT button (or the Talk button on the headset) and listen for the talk tone.
If you hear a busy tone, release the button and wait a moment before making another attempt. Ensure that PTT Express and the WLAN are enabled.
2. Start talking after hearing the talk tone.





NOTE: Holding the button for more than 60 seconds (default) drops the call, allowing others to make Group calls. Release the button when finished talking to allow others to make calls.

Responding with a Private Response

The Private Response can only be initiated once a Group Call has been established. The initial Private Response is made to the originator of the Group Call.

1. Wait for an access tone.
2. Within 10 seconds, double-press the PTT button, and listen for the talk tone.
3. If you hear a busy tone, release the button and wait a moment before making another attempt. Ensure that PTT Express and the WLAN are enabled.
4. Start talking after the talk tone plays.
5. Release the button when finished talking.

Disabling PTT Communication

1. Swipe up from the bottom of the Home screen and touch .
2. Slide the **Enable/Disable Switch** to the **OFF** position. The button changes to **OFF**.
3. Touch .

RxLogger

RxLogger is a comprehensive diagnostic tool that provides app and system metrics. Create custom plug-ins that work seamlessly with this tool. RxLogger diagnoses device and application issues, and tracks information for: CPU load, memory load, memory snapshots, battery consumption, power states, wireless logging, TCP dumps, Bluetooth logging, GPS logging, logcat, ANR dumps, etc. All logs and files generated are saved in flash storage on the device (internal or external).

Figure 71 RxLogger

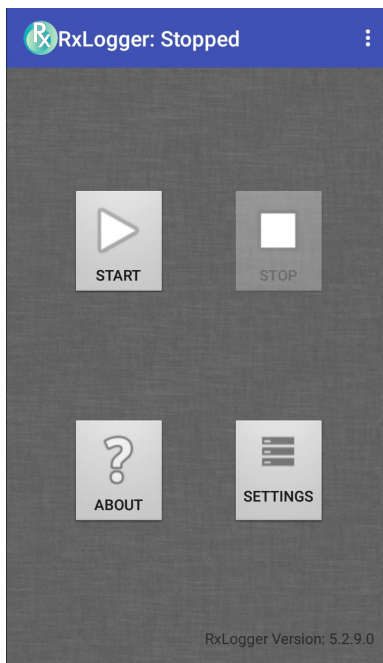

RxLogger Utility

RxLogger Utility is a data monitoring application for viewing logs in the device while RxLogger is running. Access the logs and RxLogger Utility features in the App View or the Overlay View.

In the App View, view logs in the RxLogger Utility.

Figure 72 RxLogger Utility App View

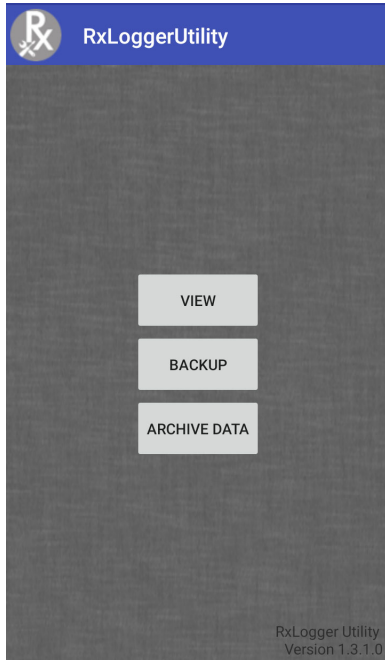

Refer to the device Integrator Guide for detailed information on the RxLogger Utility.

SimulScan Demo

The SimulScan Demo app is an out of the box demonstration app, included on devices that support SimulScan.

The SimulScan Demo app includes the following:

- Postal, Transportation and Logistics Example - Demonstrate the Optical Character Recognition (OCR) and Optical Mark Recognition (OMR) features.
- Manufacturing Example - Demonstrate the MultiCode 20 feature.
- Demo Customization - Create a template using the Template Builder or use a default template. Test templates on the device.

Figure 73 SimulScan Demo Home Screen

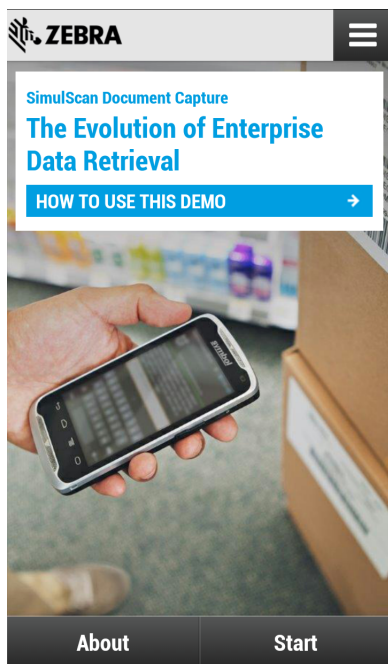

Printing the Sample Forms

In order to perform the Postal, Transportation & Logistics or Manufacturing demonstrations, print the example forms stored on the device.

1. Launch **SimulScan Demo** application.
2. On the **SimulScan Demo** home screen, touch **HOW TO USE THIS DEMO**.
3. Scroll down and touch **Export sample forms** button. The device copies the forms to the `\simulscan\samples` folder in Internal Storage.
4. Connect the device to a computer using the USB Charging cable.
5. Copy the files from the `\simulscan\samples` folder in Internal Storage to the computer.
6. Print the forms.

Using the Postal, Transportation and Logistics Example

1. Print the Postal, Transportation and Logistics form. See [Printing the Sample Forms on page 105](#).

Figure 74 Postal, Transportation and Logistics Form

1 Payer account number and insurance details		2 Non-Document Shipments Only (Customs Requirements)	
Charge to <input checked="" type="checkbox"/> Shipper <input type="checkbox"/> Receiver <input type="checkbox"/> 3rd party <small>Not all payment options are available in all countries.</small> Payer Account No. 001-12349876		Attach the original and four copies of a Proforma or Commercial Invoice Shipper's VAT/GST number 564451112 Receiver's VAT/GST or Shipper's EIN/SSN 1111577738 Harmonised Commodity Code if applicable	
Shipment Insurance see reverse <input checked="" type="checkbox"/> Yes Insurance value (in local currency) 1400		Destination duties/taxes if left blank receiver pays duties/taxes <input type="checkbox"/> Receiver <input type="checkbox"/> Shipper <input type="checkbox"/> Other _____ <small>specify approved account number</small>	
3 From (Shipper)		4 To (Receiver)	
Shipper's account number 155-22263 Company name Pure Theory Ltd Address 163B Lansdown Drive Fitzrovia, London England WC2 1AB		Company name TFW Solutions Delivery address <small>We cannot deliver to a PO Box</small> Solvalla Travbaneplan 12A 64 Bromma Postcode/Zip Code (required) 286 32 Country Sweden	
Contact name Scott Andrews Phone, Fax or E-mail (required) 0207 553633		Contact person Aidan Peterson Phone, Fax or E-mail (required) +46 8 123 89 67	
5 Shipper's agreement			
<small>(Signature required) Unless otherwise agreed in writing, I/we agree to the Terms and Conditions of Carriage between me/us and (1) such Terms and Conditions and, where applicable, the Convention limits and/or excludes liability for loss, damage or delay and (2) this shipment does not contain cash or dangerous goods (see reverse).</small>			
Signature  Date 10 / 10 / 13			

For more information visit our website or call our local office

2. Place the form on a flat surface.
3. On the device, launch **SimulScan Demo** app.
4. Touch the **Menu** icon in the top right corner of the screen.
5. Touch **Postal, Transportation & Logistics**.
6. Touch **Start SimulScan**.

- Use the image control at the bottom of the screen to control the flash, audio and zoom level.

Figure 75 Image Controls

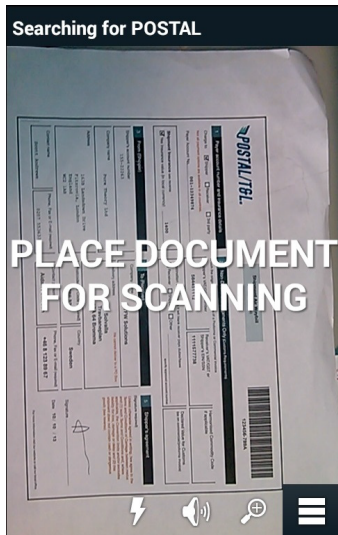

- Position the camera over the form. Ensure that the complete border of the form is visible on the screen.
- Hold the device steady.
- Once the device detects the form **Tap Screen to Scan** appears on the screen.
- Tap the screen to start the data capture. When completed, the device beeps and the data from the form displays.

Figure 76 Postal Data Screen

POSTAL	
Field	Parsed Data
Barcode	123456-789A
Charge To	<input checked="" type="checkbox"/>
Account Number	155-22253
Shipper Name	<div style="border: 1px solid red; background-color: #ffe6e6; padding: 2px;"> ▲ Check Result Pssupcs Thckry Ltd </div> Pure Theory Ltd
Shipper Address	<div style="border: 1px solid red; background-color: #ffe6e6; padding: 2px;"> ▲ Check Result 1538 Landsdown Drive lill,tgrav;la, ll;pdolrls England WC2 IAB </div> 163B Landsdown Drive Fitzrovia, London England WC2 IAB
RESCAN ACCEPT	

- Touch the text boxes to correct any errors. Note: if there are too many errors, touch **Rescan** to perform the capture again.

13. Touch **Accept** to confirm the data is correct. The **Results summary** screen appears.

14. Touch **OK**.

Using the Manufacturing Example

1. Print the Manufacturing form. See [Printing the Sample Forms on page 105](#).

Figure 77 Manufacturing Form

The image shows a screenshot of a mobile application interface for an MSI reader. The screen displays the following information:

- Top Left:** A purple gear icon with a white 'M' inside.
- Top Center:** The text "MSI reader".
- Top Right:** A small black icon and the text "<5 kgs MV unit".
- Part Number:** "PART NUMBER (P) 5290261-69" with a large barcode below it.
- Supplier:** "SUPPLIER (V) V4305156059" with a large barcode below it.
- Quantity:** "QUANTITY (Q) 000128" with a small barcode below it.
- Pkg ID/Serial Number:** "PKG ID/SERIAL NUMBER (IS) 1SX1000114" with a small barcode below it.
- Made in Mexico:** "MADE IN MEXICO" with a small barcode below it.
- Bottom Right:** A purple gear icon with a white 'M' inside and the text "MANUFACTURING LTD".

2. Place the form on a flat surface.
3. On the device, launch **SimulScan Demo** app.
4. Touch the **Menu** icon in the top right corner of the screen.
5. Touch **Manufacturing**.
6. Touch **Start SimulScan**.
7. Point the top of the device at the document and center the target on the document.
8. Hold the device steady.

- The device starts the data capture. When completed, the device beeps and the data from the document displays.

Figure 78 Manufacturing Data

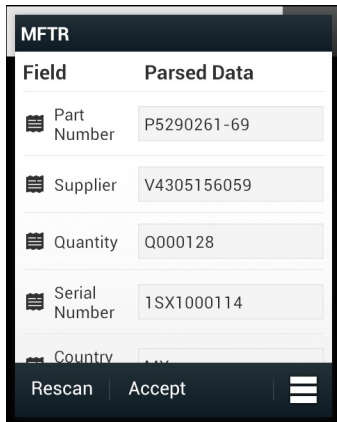

- Touch the text boxes to correct any errors. If there are too many errors, touch **Rescan** to perform the capture again.
- Touch **Accept** to confirm the data is correct. The **Results summary** screen appears.
- Touch **OK**.

Settings

To set the settings for the **SimulScan Demo** application touch **Menu** icon > **Settings**.

Figure 79 Settings Screen

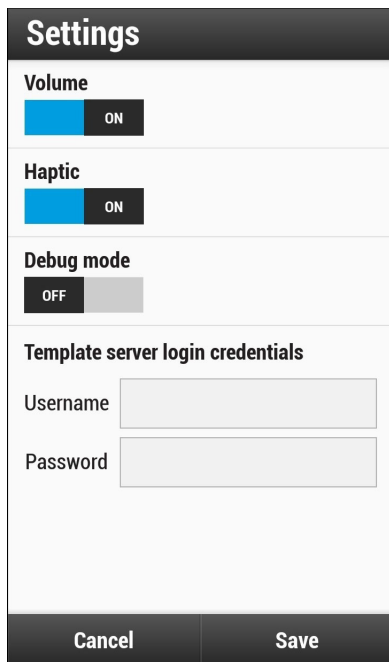

- Volume** - Toggle switch to turn audible notification on and off.
- Haptic** - Toggle switch to turn vibration notification on and off.

- **Debug mode** - Toggle switch to enable or disable debug mode.
- **Template server login credentials** - enter credentials for accessing the template server.

Advanced Settings

Use the Advanced setting to configure data capture options. In the data capture screen, touch  in the bottom right corner of the screen.

Figure 80 Advanced Settings Screen



- **Identification Timeout** - Set the amount of time to wait before timing out identifying the target document. Options: **2 seconds**, **5 seconds**, **10 seconds**, **15 seconds**, **20 seconds** or **25 seconds**.
- **Processing Timeout** - Once the target document is identified, amount of time to wait before timing out processing.
- **Audio Feedback** - Turn on or off audio feedback on successful parse.
- **Haptic Feedback** - Turn on or off haptic (vibration) feedback on successful parse.
- **LED Feedback** - Turn on or off LED feedback on successful parse.
- **Debug Mode** - If enabled, allows a session to write form capture, region images, region values, and other data to storage. Use only when directed by administrator.
- **Auto Capture** - Set to **On** to automatically capture forms when detected. Set to **Off** to manually capture forms when user taps screen or presses a trigger button.
- **Image Correction** - Turn on when document is crumpled or curved and requires advanced image correction.
- **Capture Sensitivity** - Increase sensitivity for increased document identification accuracy before processing.
- **About** - Displays the SimulScan Engine version number.
- **Quit Scanner** - Exit Advanced Settings screen.

Creating a Demo Customization

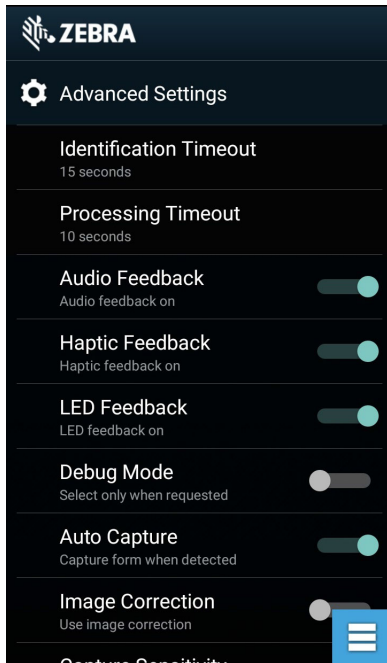
Before creating a customized demo, first:

- Create a template using the Template Builder tool.
- Copy a company logo and image to the device storage location.

1. Touch **Menu** icon.
2. Touch **Setup Custom Demo**.

Figure 81 Custom Demo Setup Screen

The screenshot shows a mobile application screen titled "Title". It contains several text input fields and two buttons at the bottom. The fields are labeled "Name", "Custom Demo Setup", "Image", "Logo", "Introduction", "Header Color", and "Icon color". The "Name" field contains "Custom Demo", and the "Custom Demo Setup" field also contains "Custom Demo". The "Image" field contains "Image.jpg" and the "Logo" field contains "Logo.jpg". The "Introduction" field contains the text: "Whether capturing multiple barcodes, delivery sheets, distribution manifests or inventory tables, SimulScan Document Capture saves you hours." The "Header Color" and "Icon color" fields are empty. At the bottom, there are two buttons: "Cancel" and "Done".

3. In the **Name** text box, enter a name for the custom demo that appears in the drop-down menu.
4. In the **Custom Demo Setup** text box, enter a title for the demo that appears in the demo screen title box.
5. Touch the **Image** field to select an image from the SD card.
6. Touch the **Logo** field to select the logo image from the SD card.
7. In the **Introduction** text box, enter text that appears on the demo screen.
8. In the **Header color** text box, enter the hex color value for the header.
9. In the **Icon color** text box, enter the hex color value for Menu icon and button text.
10. In the **Key Features** text box, enter text that appears in bullet format under the Key Feature heading.
11. Touch one of the **SimulScan Document Capture Template** fields to select a template
 - a. **Browse external storage** - select a template loaded on the device.
 - b. **Default templates** - select one of the default templates.
 - c. **Select from server** - select a template from the SimulScan server.
12. Touch **Done**. The customized example appears on the screen.

13. Touch **Start SimulScan** to begin the demonstration.

Default Templates

The following templates are available:

- **Default - BankCheck.xml** – Reads the MICR E-13B font (length between 19 and 40 characters) on bank checks.
- **Default - Barcode 1.xml** – Reads a single supported bar code.
- **Default - Barcode 10.xml** – Reads up to 10 supported bar codes.
- **Default - Barcode 2.xml** – Reads two supported bar codes.
- **Default - Barcode 4.xml** – Reads up to supported four bar codes.
- **Default - Barcode 5.xml** – Reads up to supported five bar codes.
- **Default - BookNumber.xml** – Reads the OCR-B ISBN 10 or 13 digit book numbers.
- **Default - DocCap + Optional Barcode** – Captures a full page image and decode any supported bar codes that are in the form. The captured area is the largest rectangular region in the field of view defined by the solid border or contrast of background. Any OCR or OMR content will not be decoded in this mode. The captured area is further processed to correct, de-skew and sharpen and returned as a picture.
- **Default - DocCap + Required Barcode** – Captures a full page image and decode of any supported bar codes that are present in the form. The captured area is the largest rectangular region in the field of view defined by the solid border or contrast of background. Any OCR or OMR content will not be decoded in this mode. The captured area is further processed to correct, de-skew and sharpen and returned as a picture.
- **Default - TravelDoc.xml** – Reads passport and Visa travel documents with OCR-B types A and B fonts.
- **Default - Unstructured Multi-Line** – Reads up to seven lines of text.
- **Default - Unstructured Single Line** – Reads a single line of text.

Sound Recorder

Use **Sound Recorder** to record audio messages.

Recordings are saved on the microSD card (if installed) or the internal storage and are available in the Music application (non-GMS devices) or the Play Music application (GMS devices).

Figure 82 Sound Recorder Application

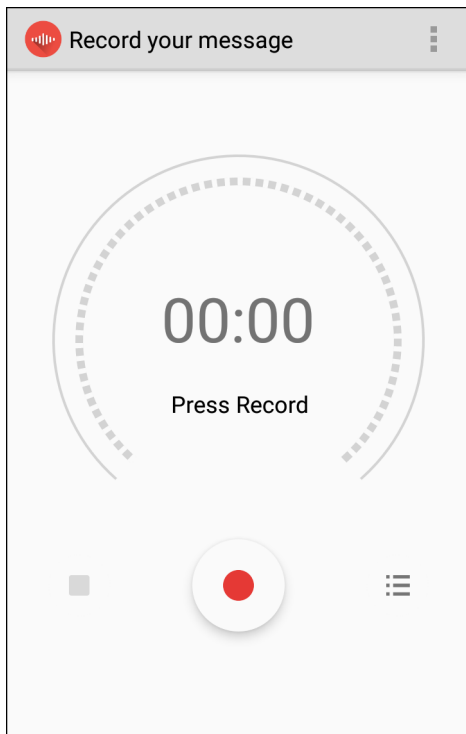

Touch **☰** to open options menu.

- **File type** - Select the file type for the recording file.
 - **AMR**
 - **3GPP**
 - **AAC**
 - **WAV**
 - **AMR-WR**
 - **AMR-WB-3GPP.**
- **Storage location** - Select the location for the recording file.
 - **Phone storage**
 - **SD card.**

Data Capture

Introduction

The device supports data capture using:

- integrated imager
- integrated camera
- RS507/RS507x Hands-free imager
- RS6000 Bluetooth Ring Scanner
- DS3678 Digital Scanner
- LI3678 Linear Scanner
- DS2278 Digital Scanner.

Imaging

The device with an integrated 2D imager has the following features:

- Omnidirectional reading of a variety of bar code symbologies, including the most popular linear, postal, PDF417, and 2D matrix code types.
- The ability to capture and download images to a host for a variety of imaging applications.
- Advanced intuitive laser aiming cross-hair and dot aiming for easy point-and-shoot operation.

The imager uses imaging technology to take a picture of a bar code, stores the resulting image in its memory, and executes state-of-the-art software decoding algorithms to extract the bar code data from the image.

Digital Camera

The device with an integrated camera based barcode scanning solution has the following features:

- Omnidirectional reading of a variety of barcode symbologies, including the most popular linear, postal, QR, PDF417, and 2D matrix code types.
- Cross-hair reticle for easy point-and-shoot operation.
- Picklist mode to decode a particular barcode from many in the field of view.

The solution uses the advanced camera technology to take a digital picture of a barcode, and executes state-of-the-art software decoding algorithms to extract the data from the image.

Linear Imager

The device with an integrated linear imager has the following features:

- Reading a variety of bar code symbologies, including the most popular 1-D code types.
- Intuitive aiming for easy point-and-shoot operation.

The imager uses imaging technology to take a picture of a bar code, stores the resulting image in its memory, and executes state-of-the-art software decoding algorithms to extract the bar code data from the image.

Operational Modes

The device with an integrated imager supports two modes of operation, listed below. Activate each mode by pressing the Scan button.

- **Decode Mode:** In this mode, the device attempts to locate and decode enabled barcodes within its field of view. The imager remains in this mode as long as the user holds the scan button, or until it decodes a barcode.



NOTE: To enable Pick List Mode, configure in DataWedge or set in an application using a API command.

- **Pick List Mode:** This mode allows the user to selectively decode a barcode when more than one barcode is in the device's field of view. To accomplish this, move the aiming crosshair or dot over the required barcode to decode only this barcode. This feature is ideal for pick lists containing multiple barcodes and manufacturing or transport labels containing more than one barcode type (either 1D or 2D).

NOTE: To enable Basic MultiBarcode Mode, configure in DataWedge or set in an application using a API command.

- **Basic MultiBarcode Mode:** In this mode, the device attempts to locate and decode a specific number of unique barcodes within its field of view. The device remains in this mode as long as the user holds the scan button, or until it decodes all the barcodes. Available on integrated SE2100 or SE4710 imagers only.
 - The device attempts to scan the programmed number of unique barcodes (from 2 through 10).
 - If there are duplicate barcodes (same symbology type and data), only one of the duplicate barcodes is decoded and the remainder are ignored. If the label has two duplicate barcodes plus another two different barcodes, a maximum of three barcodes will be decoded from that label; one will be ignored as a duplicate.
 - Barcodes can be of multiple symbology types and still be acquired together. For example, if the specified quantity for a Basic MultiBarcode scan is four, two barcodes can be symbology type Code 128 and the other two can be symbology type Code 39.
 - If the specified number of unique barcodes is not initially in view of the device, the device will not decode any data until the device is moved to capture the additional barcode(s) or time out occurs. If the device field of view contains a number of barcodes greater than the specified quantity, the device randomly decodes barcode(s) until the specified number of unique barcodes is reached. For example, if the count is set to two and eight barcodes are in the field of view, the device decodes the first two unique barcodes it sees, returning the data in random order.
 - Basic MultiBarcode Mode does not support concatenated barcodes.

RS507/RS507x Hands-Free Imager

The RS507 and RS507x Hands-free Imagers are wearable barcode scan solution for both 1D and 2D bar code symbologies. The scanner supports Bluetooth Human Interface Device (HID) connection to the device.

Figure 83 RS507/RS507x Hands-Free Imager

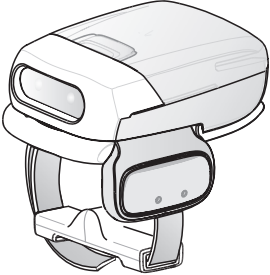

Refer to the RS507/RS507x Hands-free Imager Product Reference Guide for more information.

RS6000 Bluetooth Ring Scanner

The RS6000 Bluetooth Ring Scanner is a wearable bar code scan solution for both 1D and 2D bar code symbologies.

Figure 84 RS6000 Bluetooth Ring Scanner

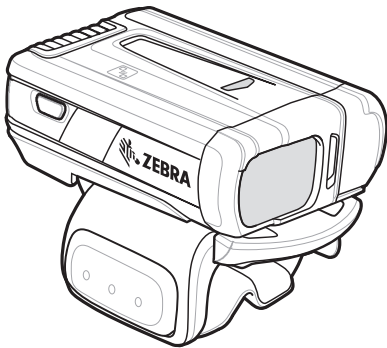

Refer to the RS6000 Bluetooth Ring Scanner Product Reference Guide for more information.

DS3678 Digital Scanner

The cordless DS3678 combines superior 1D and 2D omnidirectional bar code scanning performance and advanced ergonomics in a lightweight design.

Figure 85 DS3678 Digital Scanner

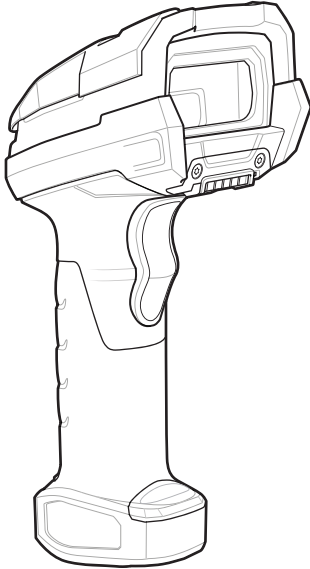

Refer to the DS36X8 Digital Scanner Product Reference Guide for more information.

LI3678 Linear Scanner

The cordless LI3678 combines excellent scanning performance and advanced ergonomics to provide the best value in a lightweight scanner, ensuring comfort and ease of use for extended periods of time.

Figure 86 LI3678 Linear Scanner

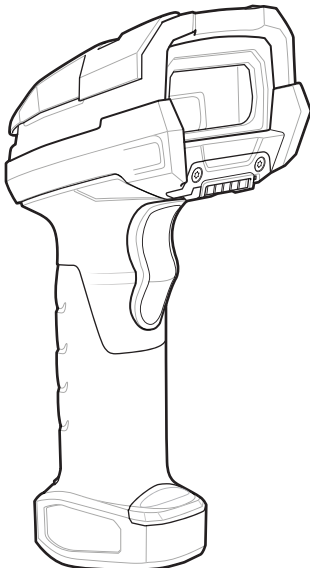

Refer to the LI36X8 Linear Scanner Product Reference Guide for more information.

DS2278 Digital Scanner

The DS2278 digital imager scanner scans both 1D and 2D bar codes and does not compromise performance or features.

Figure 87 DS2278 Digital Scanner

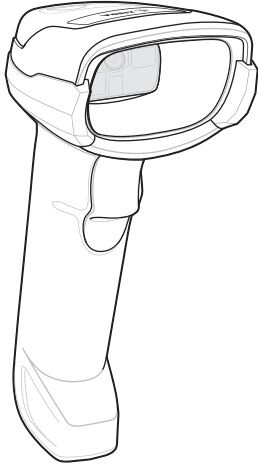

Refer to the DS22788 Digital Scanner Product Reference Guide for more information.

Scanning Considerations

Typically, scanning is a simple matter of aim, scan, and decode, with a few quick trial efforts to master it. However, consider the following to optimize scanning performance:

- **Range:** Scanners decode best over a particular working range — minimum and maximum distances from the barcode. This range varies according to barcode density and scanning device optics. Scan within range for quick and constant decodes; scanning too close or too far away prevents decodes. Move the scanner closer and further away to find the right working range for the barcodes being scanned.
- **Angle:** Scanning angle is important for quick decodes. When laser beams reflect directly back into the scanner from the barcode, this specular reflection can blind the scanner. To avoid this, scan the barcode so that the beam does not bounce directly back. Do not scan at too sharp an angle; the scanner needs to collect scattered reflections from the scan to make a successful decode. Practice quickly shows what tolerances to work within.
- Hold the device farther away for larger symbols.
- Move the device closer for symbols with bars that are close together.



NOTE: Scanning procedures depend on the app and device configuration. An app may use different scanning procedures from the one listed above.

Scanning with Internal Imager

To read a barcode, a scan-enabled app is required. The device contains the DataWedge app that allows the user to enable the imager, decode the barcode data, and display the barcode content.

To scan with the internal imager:

1. Ensure that an app is open on the device and a text field is in focus (text cursor in text field).

2. Point the exit window on the top of the device at a barcode.

Figure 88 Imager Scanning

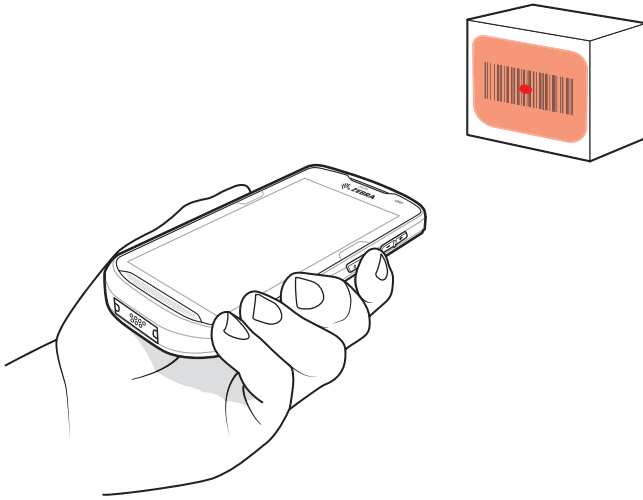

3. Press and hold the scan button.
The red laser aiming pattern turns on to assist in aiming.



NOTE: When the device is in Picklist mode, the imager does not decode the barcode until the crosshair or aiming dot touches the barcode.

4. Ensure the barcode is within the area formed by the crosshairs in the aiming pattern. The aiming dot increases visibility in bright lighting conditions.

Figure 89 Aiming Pattern

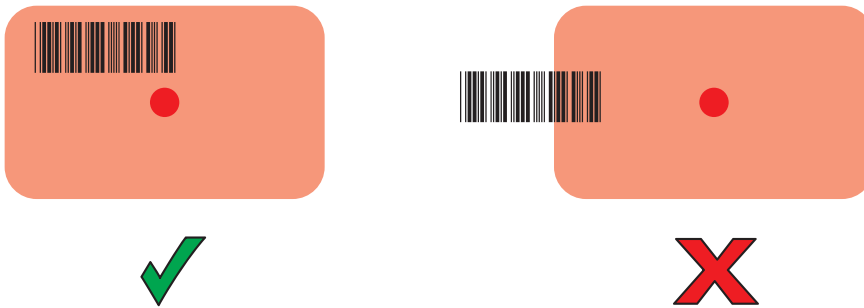
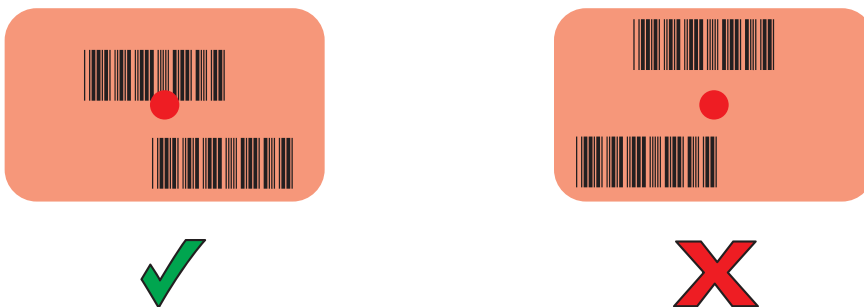

Figure 90 Pick List Mode with Multiple Barcodes



5. The Data Capture LED lights green and a beep sounds, by default, to indicate the barcode was decoded successfully.

6. Release the scan button.



NOTE: Imager decoding usually occurs instantaneously. The device repeats the steps required to take a digital picture (image) of a poor or difficult barcode as long as the scan button remains pressed.

7. The barcode content data displays in the text field.

Scanning with Internal Camera

To read a barcode, a scan-enabled app is required. The device contains the DataWedge app that allows the user to enable the imager, decode the barcode data, and display the barcode content.

To scan with the internal camera:



NOTE: When capturing barcode data in poor lighting, turn on Illumination mode in the DataWedge application.

1. Ensure that an app is open on the device and a text field is in focus (text cursor in text field).
2. Point the camera exit window on the back of the device at a barcode.

Figure 91 Camera Scanning

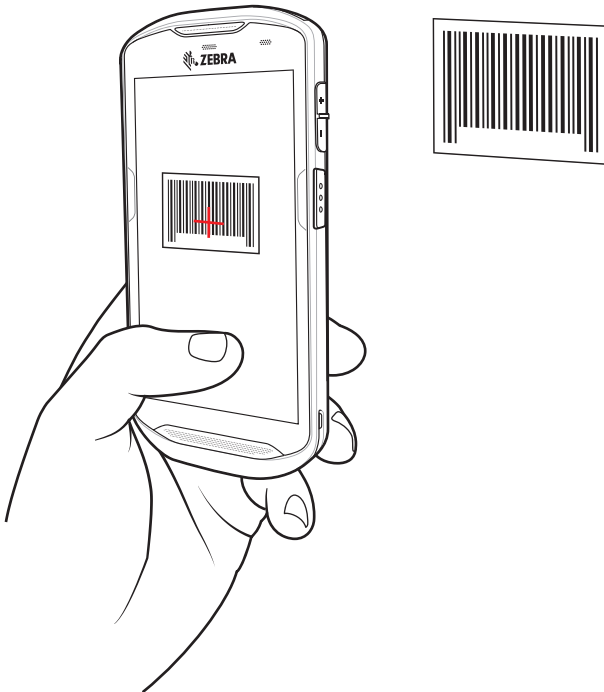

3. Press and hold the scan button. By default, a preview window appears on the screen.



NOTE: When Picklist mode is enabled, move the device until the bar code is centered under the red target on the screen.

4. Move the device until the barcode is visible on the screen.
5. The Decode LED lights green, a beep sounds and the device vibrates, by default, to indicate the bar code was decoded successfully.
6. The captured data appears in the text field.

Scanning with RS6000 Bluetooth Ring Scanner

To read a barcode, a scan-enabled app is required. The device contains the DataWedge app that allows the user to enable the scanner to decode barcode data and display the barcode content.

To scan with the RS6000:

1. Pair the RS6000 with the device. See [Pairing Using Simple Serial Interface on page 128](#) or [Pairing Using Bluetooth Human Interface Device on page 129](#) for more information.
2. Ensure that an app is open on the device and a text field is in focus (text cursor in text field).
3. Point the RS6000 at a barcode.

Figure 92 Barcode Scanning with RS6000

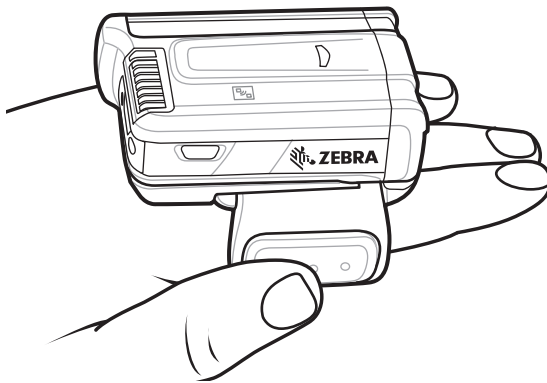

4. Press and hold the trigger.

The red laser aiming pattern turns on to assist in aiming. Ensure the barcode is within the area formed by the cross-hairs in the aiming pattern. The aiming dot increases visibility in bright lighting conditions.

The RS6000 LEDs light green and a beep sounds to indicate the barcode was decoded successfully. When the RS6000 is in Pick List mode, the RS6000 does not decode the barcode until the center of the crosshair touches the barcode.

Figure 93 RS6000 Aiming Pattern

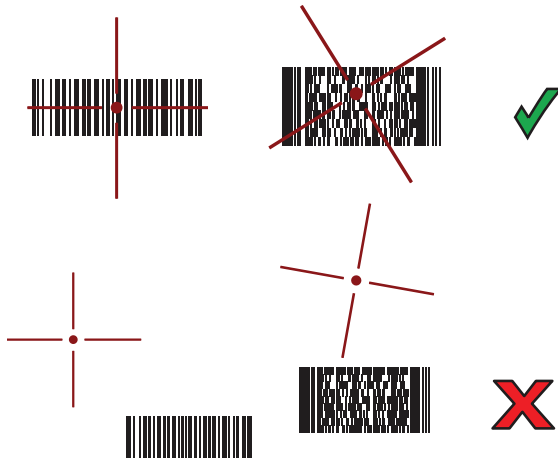

Figure 94 RS6000 Pick List Mode with Multiple Barcodes in Aiming Pattern



5. The captured data appears in the text field.

Scanning with RS507/RS507X Hands-Free Imager

To read a barcode, a scan-enabled app is required. The device contains the DataWedge app that allows the user to enable the scanner to decode barcode data and display the barcode content.

To scan with the RS507/RS507X:

1. Pair the RS507/RS507X with the device. See [Pairing Using Simple Serial Interface on page 128](#) or [Pairing in HID Mode Using Near Field Communication on page 127](#) for more information.
2. Ensure that an app is open on the device and a text field is in focus (text cursor in text field).

- Point the RS507/RS507X at a barcode.

Figure 95 Barcode Scanning with RS507/RS507X

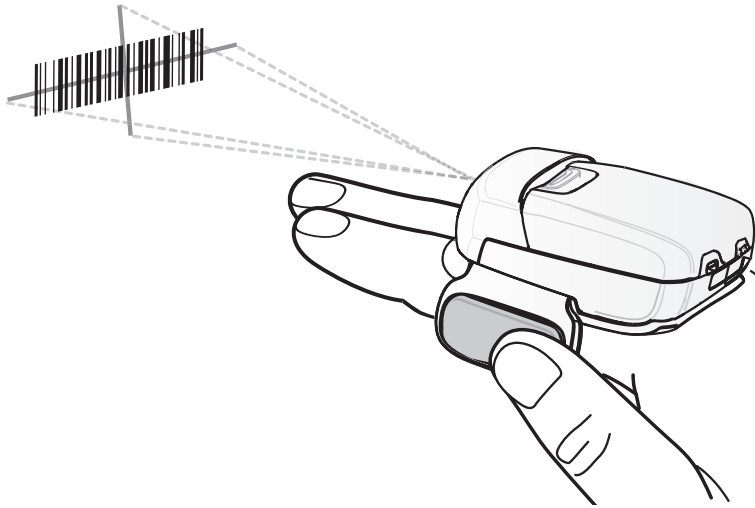

- Press and hold the trigger.

The red laser aiming pattern turns on to assist in aiming. Ensure the barcode is within the area formed by the cross-hairs in the aiming pattern. The aiming dot increases visibility in bright lighting conditions.

The RS507/RS507X LEDs light green and a beep sounds to indicate the barcode was decoded successfully. When the RS507/RS507X is in Pick List mode, the RS507/RS507X does not decode the barcode until the center of the crosshair touches the barcode.

Figure 96 RS507/RS507X Aiming Pattern



Figure 97 RS507/RS507X Pick List Mode with Multiple Barcodes in Aiming Pattern



- The captured data appears in the text field.

Scanning with DS3678 Bluetooth Scanner

To scan with the DS3678:

- Pair the DS3678 with the device. See [Pairing a Bluetooth Scanner on page 130](#) for more information.
- Ensure that an app is open on the device and a text field is in focus (text cursor in text field).
- Point the DS3678 at a barcode.

Figure 98 Barcode Scanning with DS3678 (-SR shown)

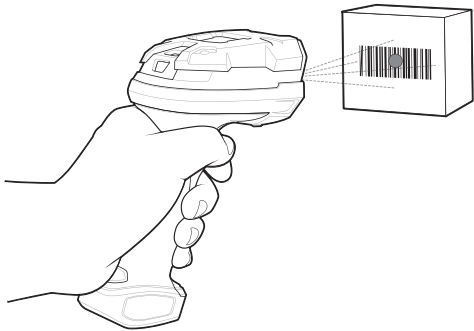

- Press and hold the trigger.

Ensure the barcode is within the area formed by the aiming pattern. The aiming dot increases visibility in bright lighting conditions.

Figure 99 DS3678-SR Aiming Pattern

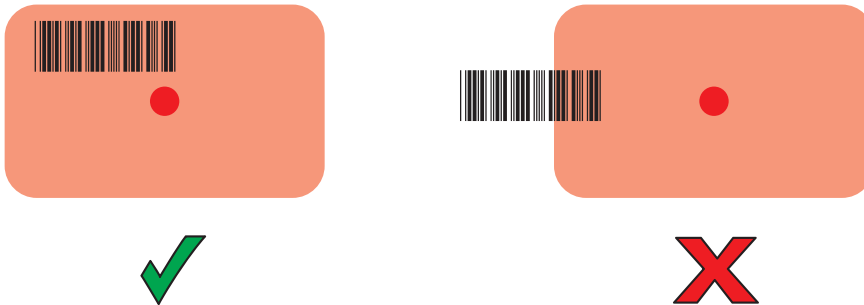
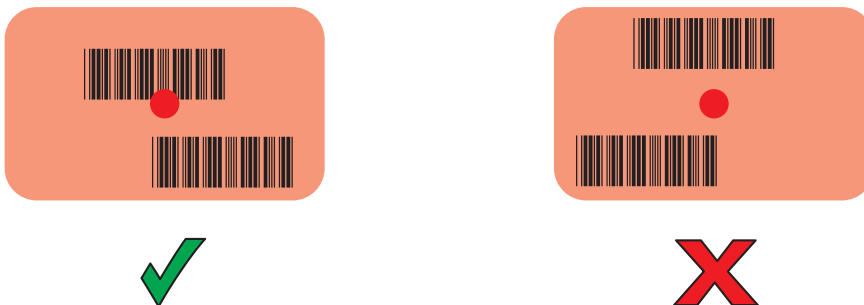

Figure 100 DS3678-SR Pick List Mode with Multiple Barcodes in Aiming Pattern



- The captured data appears in the text field.

Scanning with LI3678 Linear Imager

To scan with the LI3678:

1. Pair the LI3678 with the device. See [Pairing a Bluetooth Scanner on page 129](#) for more information.
2. Ensure that an app is open on the device and a text field is in focus (text cursor in text field).
3. Point the LI3678 at a barcode.

Figure 101 Barcode Scanning with LI3678

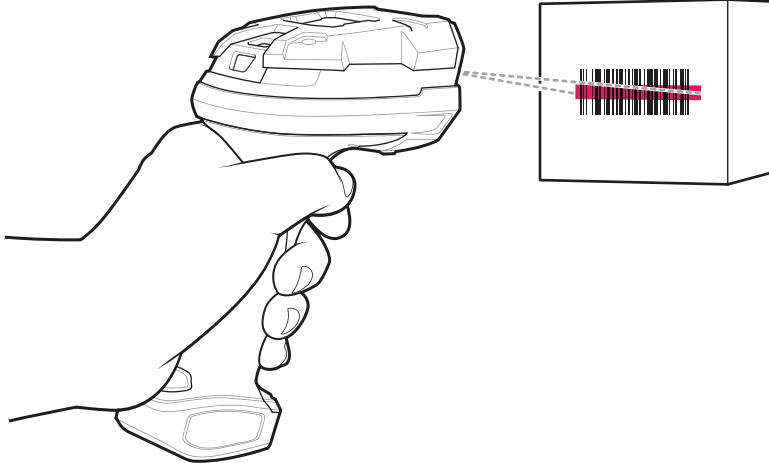

4. Press and hold the trigger.
5. Ensure the aiming pattern covers the barcode.

Figure 102 LI3678-SR Aiming Pattern

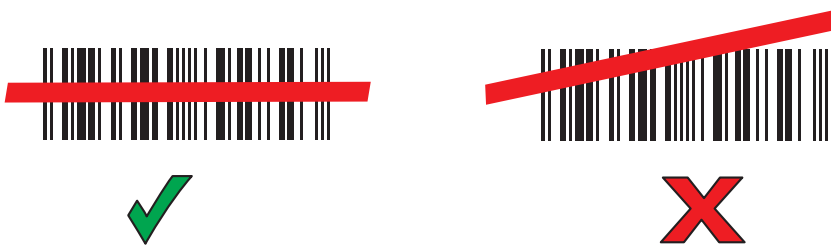

6. Upon successful decode, the scanner beeps and the LED displays a single green flash.
7. The captured data appears in the text field.

Scanning with DS2278 Digital Scanner

To scan with the DS2278:

1. Pair the DS278 with the device. See [Pairing a Bluetooth Scanner on page 129](#) for more information.
2. Ensure that an app is open on the device and a text field is in focus (text cursor in text field).

- Point the scanner at a barcode.

Figure 103 Barcode Scanning with DS2278

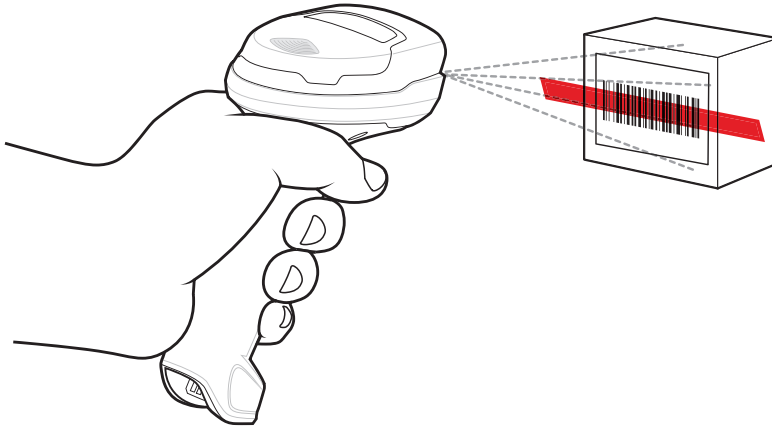

- Press and hold the trigger.
- Ensure the aiming pattern covers the barcode.

Figure 104 DS2278 Aiming Pattern



- Upon successful decode, the scanner beeps and the LED flashes, and the scan line turns off.
- The captured data appears in the text field.

Pairing the RS507/RS507X/RS6000 Hands-Free Imager

To connect the RS507/RS507X or RS6000 imager to the device, use one of the following methods:

- Near Field Communication (NFC) (RS6000 only)
- Simple Serial Interface (SSI)
- Bluetooth Human Interface Device (HID) Mode.

Pairing Using Near Field Communication

The device provides the ability to pair the RS6000 using NFC.



NOTE: RS6000 Only.

To pair using NFC:

- Ensure that the RS6000 is in SSI mode. Refer to the RS6000 User Guide for more information.

2. Ensure that NFC is enabled on the device.
3. Align the NFC icon on the RS6000 with the NFC antenna on the device.

The RS6000 Status LED blinks blue indicating that the RS6000 is attempting to establish connection with the device. When connection is established, the Status LED turns off and the RS6000 emits a single string of low/high beeps.

A notification appears on the device screen and the  icon appears in the Status bar.

Figure 105 Align NFC Antennas



Pairing in HID Mode Using Near Field Communication

The device provides the ability to pair the RS6000 in HID mode using NFC.

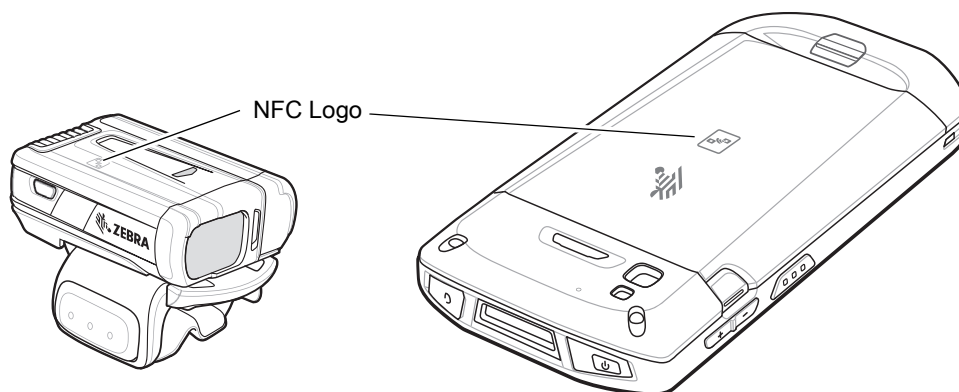

NOTE: RS6000 Only.

To pair in HID mode using NFC:

1. Ensure that NFC is enabled on the device.
2. Ensure that Bluetooth is enabled on the device.
3. Place the RS6000 in Human Interface Device (HID) mode. If the RS6000 is already in HID mode, skip to step 4.
 - a. Remove the battery from the RS6000.
 - b. Press and hold the Restore key.
 - c. Install the battery onto the RS6000.
 - d. Keep holding the Restore key for about five seconds until a chirp is heard and the Scan LEDs flash green.
 - e. Scan the barcode below to place the RS6000 in HID mode.

Figure 106 RS6000 Bluetooth HID Barcode

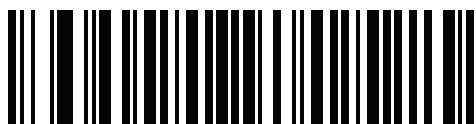

4. Remove the battery from the RS6000.
5. Re-install the battery into the RS6000.

6. Align the NFC icon on the RS6000 with the NFC antenna on the device.

The RS6000 Status LED blinks blue indicating that the RS6000 is attempting to establish connection with the device. When connection is established, the Status LED turns off and the RS6000 emits a single string of low/high beeps.

A notification appears on the device screen and the  icon appears in the Status bar.

Figure 107 Align NFC Antennas



Pairing Using Simple Serial Interface

To pair the RS507/RS507X or RS6000 with the device using SSI.

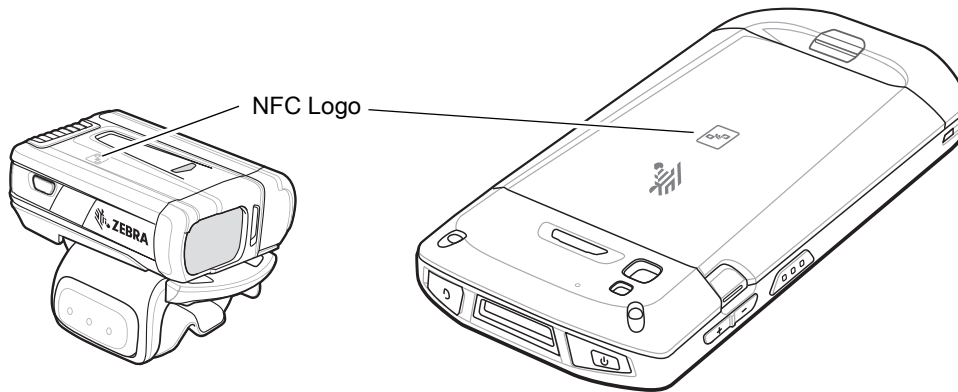

1. Swipe up from the bottom of the Home screen and touch .

Figure 108 Bluetooth Pairing Utility

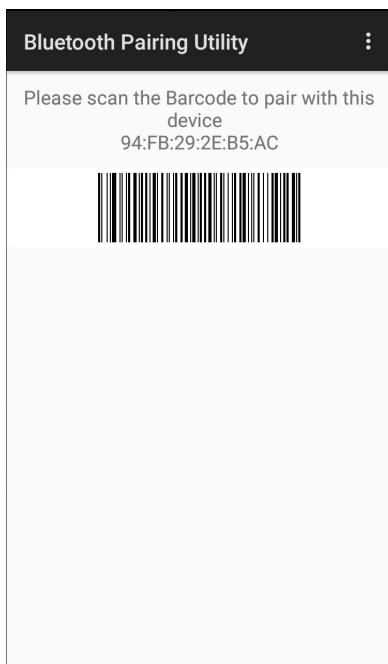

2. Using the RS507/RS507X or RS6000, scan the barcode on the screen.

The RS507/RS507X or RS6000 emits a string of high/low/high/low beeps. The Scan LED flashes green indicating that the RS507/RS507X or RS6000 is attempting to establish connection with the device. When connection is established, the Scan LED turns off and the RS507/RS507X or RS6000 emits one string of low/high beeps.

A notification appears on the Notification panel and the  icon appears in the Status bar.

Pairing Using Bluetooth Human Interface Device

To pair the RS507/RS507X or RS6000 with the device using HID:

1. Ensure that Bluetooth is enabled on both devices.
2. Ensure that the Bluetooth device to discover is in discoverable mode.
3. Ensure that the two devices are within 10 meters (32.8 feet) of one another.
4. Place the RS507/RS507X or RS6000 in Human Interface Device (HID) mode. If the RS507/RS507X or RS6000 is already in HID mode, skip to step 5.
 - a. Remove the battery from the RS507/RS507X or RS6000.
 - b. Press and hold the Restore key.
 - c. Install the battery onto the RS507/RS507X or RS6000.
 - d. Keep holding the Restore key for about five seconds until a chirp is heard and the Scan LEDs flash green.
 - e. Scan the barcode below to place the RS507/RS507X or RS6000 in HID mode.

Figure 109 RS507 Bluetooth HID Barcode



Figure 110 RS6000 Bluetooth HID Barcode

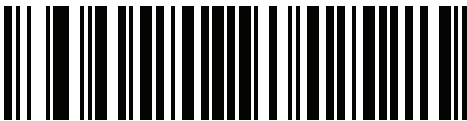

5. Remove the battery from the RS507/RS507X or RS6000.
6. Re-install the battery into the RS507/RS507X or RS6000.
7. Swipe down from the Status bar to open the Quick Access panel and then touch .
8. Touch **Bluetooth**.
9. Touch **Pair new device**. The device begins searching for discoverable Bluetooth devices in the area and displays them under **Available devices**.
10. Scroll through the list and select RS507/RS507X or RS6000.

The device connects to the RS507/RS507X or RS6000 and **Connected** appears below the device name. The Bluetooth device is added to the **Paired devices** list and a trusted (“paired”) connection is established.

A notification appears on Notification panel and the  icon appears in the Status bar.

Pairing a Bluetooth Scanner

Connect the scanner to the device using Bluetooth Human Interface Device (HID) Mode.

Pairing Using Simple Serial Interface

To pair the scanner with the device using SSI:



1. Ensure that the two devices are within 10 meters (32.8 feet) of one another.
2. Install the battery into the scanner.
3. On the device swipe up from the bottom of the Home screen and touch .

Figure 111 Bluetooth Pairing Utility

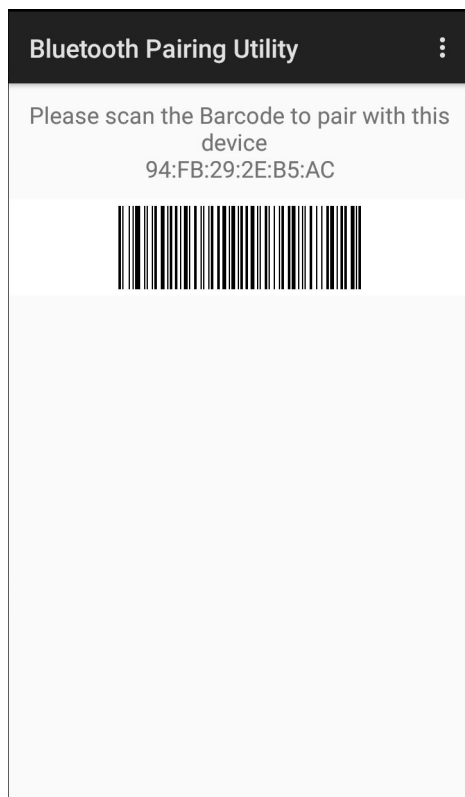

4. Using the scanner, scan the barcode on the screen.
The scanner emits a high/low/high/low beeps. The Scan LED flashes green indicating that the scanner is attempting to establish connection with the device. When connection is established, the Scan LED turns off and the scanner emits one string of low/high beeps.
5. On the device touch .

Pairing Using Bluetooth Human Interface Device

To pair the scanner with the device using HID:

1. Remove the battery from the scanner.

2. Replace the battery.
3. After the scanner reboots, scan the barcode below to place the scanner in HID mode.

Figure 112 Bluetooth HID Classic Barcode



4. On the device, swipe down from the Status bar to open the Quick Access panel and then touch .
5. Touch **Bluetooth**.
6. Touch **Pair new device**. The device begins searching for discoverable Bluetooth devices in the area and displays them under **Available devices**.
7. Scroll through the list and select XXXXX xxxxxx, where XXXXX is the scanner and xxxxxx is the serial number.



The device connects to the scanner, the scanner beeps once and **Connected** appears below the device name. The Bluetooth device is added to the **Paired devices** list and a trusted (“paired”) connection is established.

DataWedge



DataWedge is a utility that adds advanced barcode scanning capability to any application without writing code. It runs in the background and handles the interface to built-in barcode scanners. The captured barcode data is converted to keystrokes and sent to the target application as if it was typed on the keypad.

To configure DataWedge refer to the device Integrator Guide or Product Reference Guide.

Enabling DataWedge

1. Swipe up from the bottom of the Home screen and touch .
2. Touch  > **Settings**.
3. Touch the **DataWedge enabled** checkbox. A blue checkmark appears in the checkbox indicating that DataWedge is enabled.
4. Touch .

Disabling DataWedge

1. Swipe up from the bottom of the Home screen and touch .
2. Touch  > **Settings**.
3. Touch the **DataWedge enabled** checkbox. A blue checkmark disappears from the checkbox indicating that DataWedge is disabled.
4. Touch .

Wireless

Introduction

This section provides information on the wireless features:

- Wireless Local Area Network (WLAN)
- Bluetooth
- Near Field Communications (NFC)
- Cast.

Wireless Local Area Networks

Wireless local area networks (WLANs) allow the device to communicate wirelessly inside a building. Before using the device on a WLAN, the facility must be set up with the required hardware to run the WLAN (sometimes known as infrastructure). The infrastructure and the device must both be properly configured to enable this communication.

Refer to the documentation provided with the infrastructure (access points (APs), access ports, switches, Radius servers, etc.) for instructions on how to set up the infrastructure.

Once the infrastructure is set up to enforce the chosen WLAN security scheme, use the **Wireless & networks** settings configure the device to match the security scheme.

The device supports the following WLAN security options:

- Open
- Wireless Equivalent Privacy (WEP)
- Wi-Fi Protected Access (WPA)/WPA2 Personal (PSK)
- Extensible Authentication Protocol (EAP).
 - EAP-FAST - with MSCHAPV2 and GTC authentication.

The **Status** bar displays icons that indicate Wi-Fi network availability and Wi-Fi status. See [Status Bar on page 37](#) for more information.



NOTE: To extend the life of the battery, turn off Wi-Fi when not in use.

Scanning and Connecting to a Wi-Fi Network

To scan and connect to a Wi-Fi network:

1. Swipe down from the Status bar to open the Quick Access panel.

Figure 113 Quick Access Panel

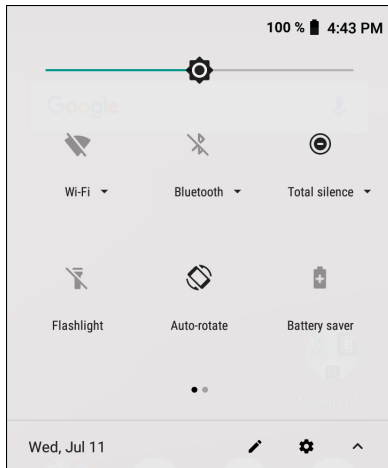

2. Touch **Wi-Fi** to open the **Wi-Fi** screen. The device searches for WLANs in the area and lists them.

Figure 114 Wi-Fi Screen

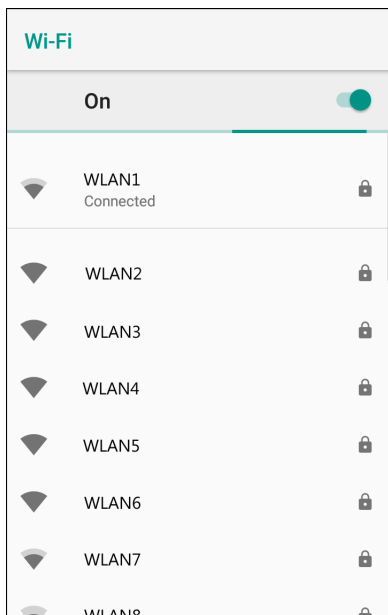



3. Scroll through the list and select the desired WLAN network.
4. For open networks, touch profile once or press and hold and then select **Connect to network** or for secure networks enter the required password or other credentials then touch **Connect**. See the system administrator for more information.

The device obtains a network address and other required information from the network using the dynamic host configuration protocol (DHCP) protocol. To configure the device with a fixed internet protocol (IP) address, Refer to the device Integrator Guide for more information.

5. In the Wi-Fi setting field, **Connected** appears indicating that the device is connected to the WLAN.

Removing a Wi-Fi Network

To remove a remembered or connected network:

1. Swipe down from the status bar to open the quick access panel and then touch .
2. Touch **Network & Internet > W-Fi**.
3. Scroll down to the bottom of the list and touch **Saved networks**.
4. Touch the name of the network.
5. In the dialog box, touch **FORGET**.
6. Touch .

Bluetooth

Bluetooth devices can communicate without wires, using frequency-hopping spread spectrum (FHSS) radio frequency (RF) to transmit and receive data in the 2.4 GHz Industry Scientific and Medical (ISM) band (802.15.1). Bluetooth wireless technology is specifically designed for short-range (10 m (32.8 ft)) communication and low power consumption.

Devices with Bluetooth capabilities can exchange information (e.g., files, appointments, and tasks) with other Bluetooth enabled devices such as printers, access points, and other mobile devices.

The device supports Bluetooth Low Energy. Bluetooth Low Energy is targeted at applications in the healthcare, fitness, security, and home entertainment industries. It provides reduced power consumption and cost while maintaining standard Bluetooth range.

Adaptive Frequency Hopping

Adaptive Frequency Hopping (AFH) is a method of avoiding fixed frequency interferers, and can be used with Bluetooth voice. All devices in the piconet (Bluetooth network) must be AFH-capable in order for AFH to work. There is no AFH when connecting and discovering devices. Avoid making Bluetooth connections and discoveries during critical 802.11b communications. AFH for Bluetooth consists of four main sections:

- Channel Classification - A method of detecting an interference on a channel-by-channel basis, or pre-defined channel mask.
- Link Management - Coordinates and distributes the AFH information to the rest of the Bluetooth network.
- Hop Sequence Modification - Avoids interference by selectively reducing the number of hopping channels.
- Channel Maintenance - A method for periodically re-evaluating the channels.

When AFH is enabled, the Bluetooth radio “hops around” (instead of through) the 802.11b high-rate channels. AFH coexistence allows enterprise devices to operate in any infrastructure.

The Bluetooth radio in this device operates as a Class 2 device power class. The maximum output power is 2.5 mW and the expected range is 10 m (32.8 ft). A definition of ranges based on power class is difficult to obtain due to power and device differences, and whether in open space or closed office space.



NOTE: It is not recommended to perform Bluetooth wireless technology inquiry when high rate 802.11b operation is required.

Security

The current Bluetooth specification defines security at the link level. Application-level security is not specified. This allows application developers to define security mechanisms tailored to their specific need. Link-level security occurs between devices, not users, while application-level security can be implemented on a per-user basis. The Bluetooth specification defines security algorithms and procedures required to authenticate devices, and if needed, encrypt the data flowing on the link between the devices. Device authentication is a mandatory feature of Bluetooth while link encryption is optional.

Pairing of Bluetooth devices is accomplished by creating an initialization key used to authenticate the devices and create a link key for them. Entering a common personal identification number (PIN) in the devices being paired generates the initialization key. The PIN is never sent over the air. By default, the Bluetooth stack responds with no key when a key is requested (it is up to user to respond to the key request event). Authentication of Bluetooth devices is based-upon a challenge-response transaction. Bluetooth allows for a PIN or passkey used to create other 128-bit keys used for security and encryption. The encryption key is derived from the link key used to authenticate the pairing devices. Also worthy of note is the limited range and fast frequency hopping of the Bluetooth radios that makes long-distance eavesdropping difficult.

Recommendations are:

- Perform pairing in a secure environment
- Keep PIN codes private and do not store the PIN codes in the device
- Implement application-level security.

Bluetooth Profiles

The device supports the Bluetooth services listed in the table below:

Table 12 Bluetooth Profiles

Profile	Description
Service Discovery Protocol (SDP)	Handles the search for known and specific services as well as general services.
Serial Port Profile (SPP)	Allows use of RFCOMM protocol to emulate serial cable connection between two Bluetooth peer devices. For example, connecting the device to a printer.
Object Push Profile (OPP)	Allows the device to push and pull objects to and from a push server.
Advanced Audio Distribution Profile (A2DP)	Allows the device to stream stereo-quality audio to a wireless headset or wireless stereo speakers.
Audio/Video Remote Control Profile (AVRCP)	Allows the device to control A/V equipment to which a user has access. It may be used in concert with A2DP.
Personal Area Network (PAN)	Allows the use of Bluetooth Network Encapsulation Protocol to provide L3 networking capabilities over a Bluetooth link. Only PANU role is supported.
Human Interface Device Profile (HID)	Allows Bluetooth keyboards, pointing devices, gaming devices and remote monitoring devices to connect to the device.
Headset Profile (HSP)	Allows a hands-free device, such as a Bluetooth headset, to place and receive calls on the device.
Hands-Free Profile (HFP)	Allows car hands-free kits to communicate with the device in the car.

Table 12 Bluetooth Profiles (Continued)

Profile	Description
Phone Book Access Profile (PBAP)	Allows exchange of Phone Book Objects between a car kit and a mobile device to allow the car kit to display the name of the incoming caller; allow the car kit to download the phone book so the user can initiate a call from the car display.
Out of Band (OOB)	Allows exchange of information used in the pairing process. Pairing is completed using the Bluetooth radio, but requires information from the OOB mechanism. Using OOB with NFC enables pairing when devices simply get close, rather than requiring a lengthy discovery process.
Symbol Serial Interface (SSI)	Allows for communication with Bluetooth Imager.
Generic Attribute Profile (GATT)	Provides profile discovery and description services for Bluetooth Low Energy protocol. It defines how attributes are grouped together into sets to form services.
Dial Up Networking (DUN)	Provides a standard to access the Internet and other dial-up services over Bluetooth.
Generic Access Profile (GAP)	Use for device discovery and authentication.
OBject EXchange (OBEX)	Facilitates the exchange of binary objects between devices.

Bluetooth Power States

The Bluetooth radio is off by default:

- Suspend - When the device goes into suspend mode, the Bluetooth radio stays on.
- Airplane Mode - When the device is placed in Airplane Mode, the Bluetooth radio turns off. When Airplane mode is disabled, the Bluetooth radio returns to the prior state. When in Airplane Mode, the Bluetooth radio can be turned back on if desired.

Bluetooth Radio Power



Turn off the Bluetooth radio to save power or if entering an area with radio restrictions (e.g., an airplane). When the radio is off, other Bluetooth devices cannot see or connect to the device. Turn on the Bluetooth radio to exchange information with other Bluetooth devices (within range). Communicate only with Bluetooth radios in close proximity.



NOTE: To achieve the best battery life, turn off radios when not in use.



Enabling Bluetooth

To enable Bluetooth:

1. Swipe down from the Status bar to open the Quick Access panel.
2. Touch  to turn Bluetooth on.
3. Touch .

Disabling Bluetooth

To disable Bluetooth:

1. Swipe down from the Status bar to open the Quick Access panel.
2. Touch  to turn Bluetooth off.
3. Touch .



Discovering Bluetooth Device(s)

The device can receive information from discovered devices without pairing. However, once paired, the device and a paired device exchange information automatically when the Bluetooth radio is on. To find Bluetooth devices in the area:

1. Ensure that Bluetooth is enabled on both devices.
2. Ensure that the Bluetooth device to discover is in discoverable mode.
3. Ensure that the two devices are within 10 meters (32.8 feet) of one another.
4. Swipe down from the Status bar to open the Quick Access panel.
5. Touch **Bluetooth**.
6. Touch **MORE SETTINGS**. The **Bluetooth** screen appears.
7. Touch **Pair new device**. The device begins searching for discoverable Bluetooth devices in the area and displays them under **Available devices**.
8. Scroll through the list and select a device. The Bluetooth pairing request dialog box appears.
9. Touch **Pair** on both devices.
10. The Bluetooth device is added to the **Paired devices** list and a trusted (“paired”) connection is established.

Changing the Bluetooth Name

By default, the device has a generic Bluetooth name that is visible to other devices when connected.

1. Swipe down from the Status bar to open the Quick Access panel and then touch .
2. Touch **Connected devices > Bluetooth**.
3. If Bluetooth is not on, move the switch to turn Bluetooth on.
4. Touch **Device name**.
5. Enter a name and touch **RENAME**.
6. Touch .



Connecting to a Bluetooth Device

Once paired, connect to a Bluetooth device.

1. Swipe down from the Status bar to open the Quick Access panel and then touch .
2. Touch **Connected device > Bluetooth**.
3. In the list, touch the unconnected Bluetooth device.
When connected, **Connected** appears below the device name.



Selecting Profiles on the Bluetooth Device

Some Bluetooth devices have multiple profiles. To select a profile:

1. Swipe down from the Status bar to open the Quick Access panel and then touch .
2. Touch **Connected Devices > Bluetooth**.
3. In the **Paired Devices** list, touch  next to the device name.
4. Turn on or off a profile to allow the device to use that profile.
5. Touch .

Unpairing a Bluetooth Device

To unpair a Bluetooth device and erase all pairing information:

1. Swipe down from the Status bar to open the Quick Access panel and then touch .
2. Touch **Connected devices > Bluetooth**.
3. In the **Paired Devices** list, touch  next to the device name.
4. Touch **FORGET**.
5. Touch .

Near Field Communications

NFC/HF RFID is a short-range wireless connectivity technology standard that enables secure transaction between a reader and a contactless smartcard. The technology is based on ISO/IEC 14443 type A and B (proximity) and ISO/IEC 15693 (vicinity) standards, using the HF 13.56 MHz unlicensed band. The device supports the following operating modes:

- Reader mode
- Peer-to-Peer communication
- Card Emulation mode.

Using NFC, the device can:

- Read contactless cards such as contactless tickets, ID cards and ePassport.
- Read and write information to contactless cards such as SmartPosters and tickets, as well as devices with NFC interface such as vending machines.
- Read information from supported medical sensors.
- Pair with supported Bluetooth devices such as printers, ring scanners (ex. RS6000), and headsets (ex. HS3100).
- Exchange data with another NFC device.
- Emulate contactless card such as payment, ticket, or SmartPoster.

The device NFC antenna is positioned to read NFC cards from the top of the device while the device is being held.

Reading NFC Cards

To read NFC cards:

1. Launch an NFC enabled application.
2. Hold device as shown.

Figure 115 Reading Cards

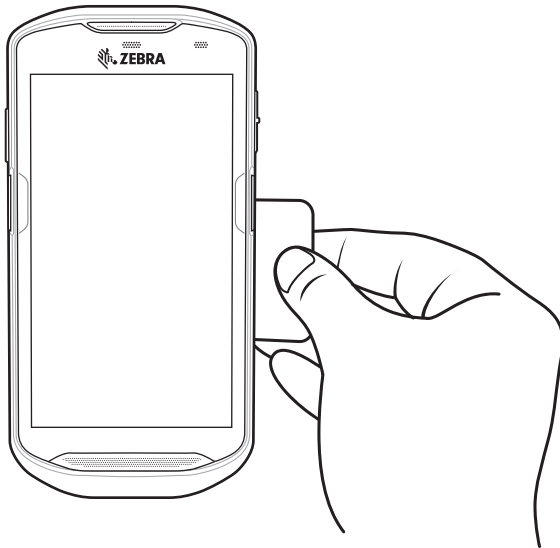

3. Move the device close to the NFC card until it detects the card.
4. Hold the card steadily until the transaction is complete (usually indicated by the application).

Sharing Information Using NFC

You can beam content like a web page, contact cards, pictures, YouTube links or location information from your screen to another device by bringing the devices together back to back.

Make sure both devices are unlocked, support NFC, and have both NFC and Android Beam turned on.

1. Open a screen that contains a web page, video, photo or contact.

2. Move the back of the device toward the back of the other device.

Figure 116 Sharing Data Using NFC

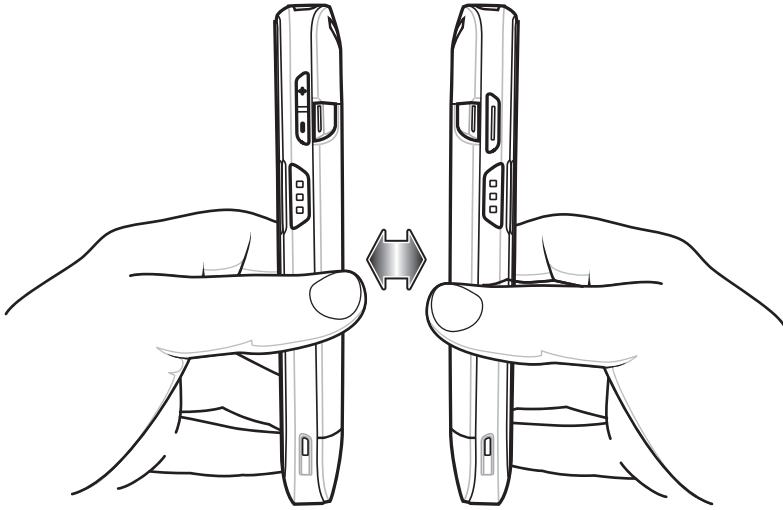



When the devices connect, a sound emits, the image on the screen reduces in size, the message **Touch to beam** displays.

3. Touch anywhere on the screen.
The transfer begins.

Cast

Use **Cast** to mirror the device screen on a Miracast enabled wireless display.

1. Swipe down from the Status bar to open the Quick Settings bar and then touch .
2. Touch **Connected Devices**.
3. Touch **Cast**.
4. Touch  > **Enable wireless display**. The device searches for nearby Miracast devices and lists them.
5. Touch a device to begin casting.
6. Touch .

Accessories

Introduction

This chapter provides information for using the accessories for the device.

Accessories

This table lists the accessories available for the device.

Table 13 *Accessories*

Accessory	Part Number	Description
Cradles		
1-Slot USB/Charge Only Cradle Kit	CRD-TC51-1SCU-01	Provides device charging and communication. Includes cradle, power supply (PWR-BGA12V50W0WW) and DC line cord.
4-Slot Charge Only Cradle with Battery Charger Kit	CRD-TC51-5SC4B-01	Charges up to four devices and four spare batteries. Includes cradle, power supply (PWR-BGA12V108W0WW) and DC line cord
5-Slot Charge Only Cradle Kit	CRD-TC51-5SCHG-01	Charges up to five devices. Includes, cradle, power supply (PWR-BGA12V108W0WW) and DC line cord.
5-Slot Ethernet Cradle Kit	CRD-TC51-5SETH-01	Provides device charging and provides Ethernet communication for up to five devices. Includes cradle, power supply (PWR-BGA12V108W0WW) and DC line cord.
Cradle Mount	BRKT-SCRD-SMRK-01	Mounts the 5-Slot Charge Only Cradle, 5-Slot Ethernet Cradle, and 4-Slot Battery Charger to a wall or rack.
USB-Ethernet Adapter	KT-TC51-ETH1-01	Provides USB and Ethernet communication with the 1-Slot USB/Charge Only Cradle Kit.
Batteries and Chargers		
4,300 mAh (typical) / 4,050 mAh (minimum) PowerPrecisionPlus Battery	BTRY-TC51-43MA1-01 BTRY-TC51-43MA1-10	Replacement battery (single pack). Replacement battery (10-pack).

Table 13 *Accessories (Continued)*

Accessory	Part Number	Description
4-Slot Battery Charger Kit	SAC-TC51-4SCHG-01	Charges up to four battery packs. Includes cradle, power supply (PWR-BGA12V50W0WW) and DC line cord.
Charge Only Vehicle Cradle	CRD-TC56-CVCD1-01	Charges and securely holds the device. Requires power cable CHG-AUTO-CLA1-01 or CHG-AUTO-HWIRE1-01, sold separately.
Charge and Communication Cables		
Rugged Charge/USB Cable	CBL-TC51-USB1-01	Provides communication and power to the device. Requires power supply PWR-WUA5V12W0xx.
Rugged USB-C Adapter	ADPTR-TC56-USBC-01	Provides communication and power to the device using a USB-C cable (CBL-TC5X-USBC2A-01).
USB-C Communication and Charge Cable	CBL-TC5X-USBC2A-01	Provides UBC-A to USB-C communication and power to the device.
USB Communication Cable	25-124330-01R	Provides micro USB to USB communication for use with 1-Slot USB/Charge Only Cradle Kit.
Audio Accessories		
2.5 mm Audio Adapter	CBL-TC51-HDST25-01	Plugs into the device and provides audio to a wired headset with 2.5 mm plug.
2.5 mm Headset	HDST-25MM-PTVP-01	Use for PTT and VoIP calls.
3.5 mm Audio Adapter	CBL-TC51-HDST35-01	Plugs into the device and provides audio to a wired headset with collared 3.5 mm plug.
3.5 mm Headset	HDST-35MM-PTVP-01	Use for PTT and VoIP calls.
Miscellaneous		
Rugged Boot	SG-TC5X-EXO1-01	Provides additional protection for the device.
Trigger Handle	TRG-TC51-SNP1-01	Adds gun-style handle with a scanner trigger for comfortable and productive scanning. Requires Rugged Boot.
Trigger Handle Kit (with Rugged Boot)	TRG-TC51-TRG1-01	Adds gun-style handle with a scanner trigger for comfortable and productive scanning.
Screen Protector	KT-TC51-SCRNP1-01	Add additional screen protection.
SmartDEX Solution	DEX30	Provides wireless DEX communications to the device.
Wrist Lanyard	SG-PD40-WLD1-01	Use to hold the device on wrist. For use with Trigger Handle or Rugged Boot.
Rugged I/O Connector	ADP-TC51-RGIO1-03	Replacement Rugged I/O Connector (3-pack).
Carrying Solutions		
Soft Holster	SG-TC51-HLSTR1-01	Use to hold the device on hip. Accepts device with Rugged Boot and Trigger Handle
Hand Strap	SG-TC51-EHDSTP1-03	Replacement hand strap with hand strap mounting clip (3-pack).

Table 13 Accessories (Continued)

Accessory	Part Number	Description
Basic Hand Strap	SG-TC51-BHDSTP1-03	Provide a hand strap to assist in holding the device without a Rugged Boot.
Stylus and Coiled Tether	SG-TC7X-STYLUS-03	Stylus with coiled tether (3-pack).
Power Supplies		
Power Supply	PWR-BGA12V50W0WW	Provides power to the 1-Slot USB Charge cradle and 4-Slot Spare Battery Charger. Requires AC line cord.
Power Supply	PWR-BGA12V108W0WW	Provides power to the 4-Slot Charge Only Cradle with battery Charger, 5-Slot Charge Only cradle and the 5-Slot Ethernet Cradle. Requires DC Line Cord, p/n 50-16002-029R and country specific three wire grounded AC line cord sold separately.
Power Supply	PWR-WUA5V12W0US	Provides 12 VDC, 2.5 A power to the Rugged Charge/USB cable. Includes plug adapter for use in the United States.
Power Supply	PWR-WUA5V12W0GB	Provides 12 VDC, 2.5 A power to the Rugged Charge/USB cable. Includes plug adapter for use in the European Union.
Power Supply	PWR-WUA5V12W0EU	Provides 12 VDC, 2.5 A power to the Rugged Charge/USB cable. Includes plug adapter for use in the United Kingdom.
Power Supply	PWR-WUA5V12W0AU	Provides 12 VDC, 2.5 A power to the Rugged Charge/USB cable. Includes plug adapter for use in Australia.
Power Supply	PWR-WUA5V12W0CN	Provides 12 VDC, 2.5 A power to the Rugged Charge/USB cable. Includes plug adapter for use in China.
Power Supply	PWR-WUA5V12W0IN	Provides 12 VDC, 2.5 A power to the Rugged Charge/USB cable. Includes plug adapter for use in India.
Power Supply	PWR-WUA5V12W0KR	Provides 12 VDC, 2.5 A power to the Rugged Charge/USB cable. Includes plug adapter for use in Korea.
Power Supply	PWR-WUA5V12W0BR	Provides 12 VDC, 2.5 A power to the Rugged Charge/USB cable. Includes plug adapter for use in Brazil.
DC Line Cord	CBL-DC-381A1-01	Provides power from the power supply (PWR-BGA12V108W0WW) to the 4-Slot Charge Only Cradle with Battery Charger, 5-Slot Charge Only Cradle and 5-Slot Ethernet Cradle.

Table 13 *Accessories (Continued)*

Accessory	Part Number	Description
DC Line Cord	CBL-DC-388A1-01	Provides power from the power supply (PWR-BGA12V50W0WW) to the 1-Slot USB/Charge Only Cradle and 4-Slot Battery Charger.
2-way DC Cable	CBL-DC-523A1-01	Connects one power supply (PWR-BGA12V108W0WW) to two 4-Slot Battery Chargers.
US AC Line Cord	23844-00-00R	Provide power to power supplies.

1-Slot USB Charge Cradle



CAUTION: Ensure that you follow the guidelines for battery safety described in [Battery Safety Guidelines on page 180](#).

The 1-Slot USB Charge Cradle:

- Provides 5 VDC power for operating the device.
- Charges the device's battery.
- Provides USB communication with host computer.

Figure 117 1-Slot USB Charge Cradle

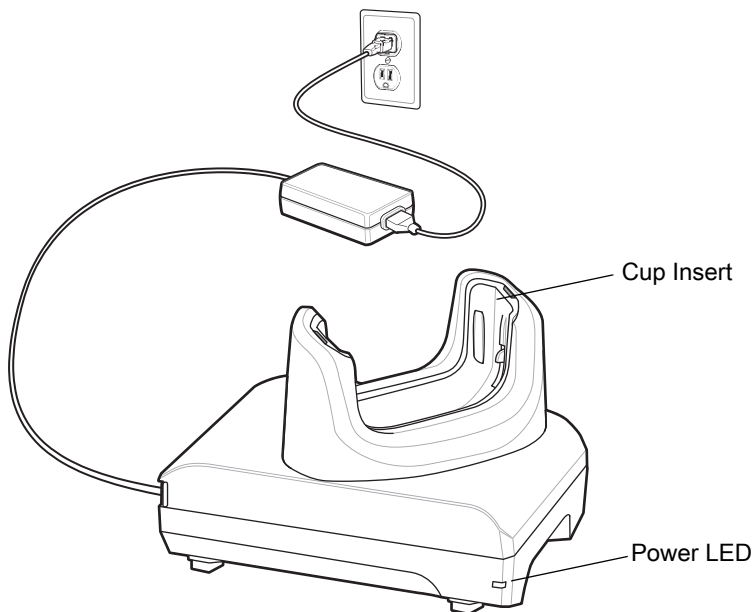

Charging the Device

To charge a device:



NOTE: If the device has a Rugged Boot, remove the cup insert before inserting the device. See Integrator Guide for details. By default, the device includes an interface connector. If the interface connector is removed for USB Type C cable connectivity, then it must be replaced before charging or receiving an Ethernet IP address if placed in a cradle.

1. Insert the device into the slot to begin charging.

Figure 118 Battery Charging

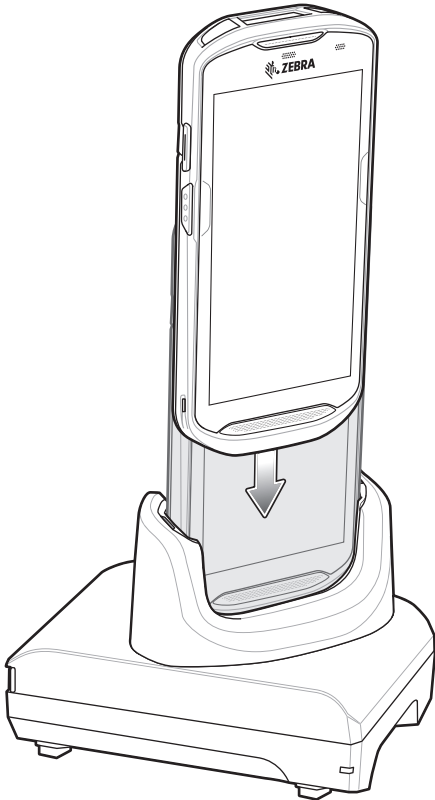

2. Ensure the device is seated properly.

Inserting a Device with Rugged Boot into Cradle

Each cradle cup has an insert that must be removed prior to inserting the device with Rugged Boot. Remove the insert and then insert the device into the cup.

Figure 119 Remove Insert from Cup

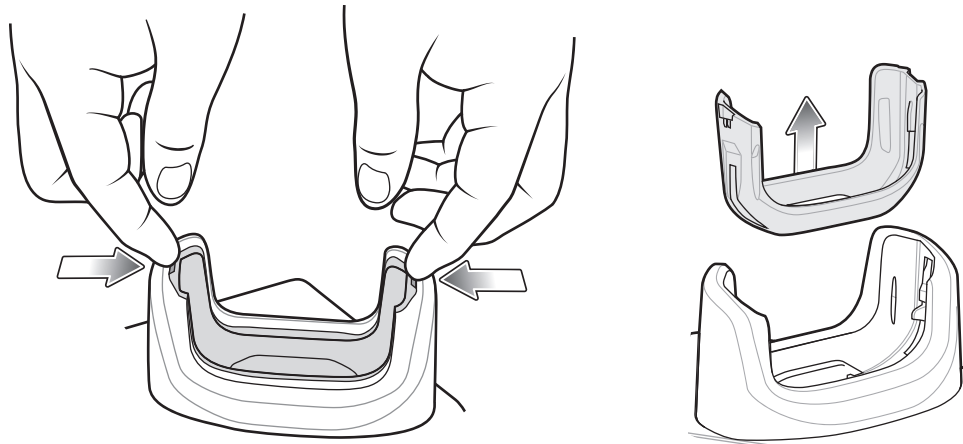

Battery Charging

The device's Charging/Notification LED indicates the status of the battery charging in the device. See Table 3 on page 22 for device charging status. The 4,150 mAh (typical) / 3,840 mAh (minimum) battery charges from fully depleted to 90% in approximately 2.5 hours and from fully depleted to 100% in approximately three hours.



NOTE: In many cases the 90% charge provides plenty of charge for daily use. A full 100% charge lasts for approximately 14 hours of use.

To achieve the best fast charging results use only Zebra charging accessories and batteries. Charge batteries at room temperature with the device in sleep mode.

Charging Temperature

Charge batteries in temperatures from 5°C to 40°C (41°F to 104°F). The device or cradle always performs battery charging in a safe and intelligent manner. At higher temperatures (e.g. approximately +37°C (+98°F)) the device or cradle may for small periods of time alternately enable and disable battery charging to keep the battery at acceptable temperatures. The device and cradle indicates when charging is disabled due to abnormal temperatures via its LED.

4-Slot Charge Only Cradle with Battery Charger



CAUTION: Ensure that you follow the guidelines for battery safety described in [Battery Safety Guidelines on page 180](#).

The 4-Slot Charge Only Cradle with Battery Charger:

- Provides 5 VDC power for operating the device.
- Simultaneously charges up to four devices and up to four spare batteries using the Battery Charger Adapter.

Figure 120 4-Slot Charge Only Cradle with Battery Charger

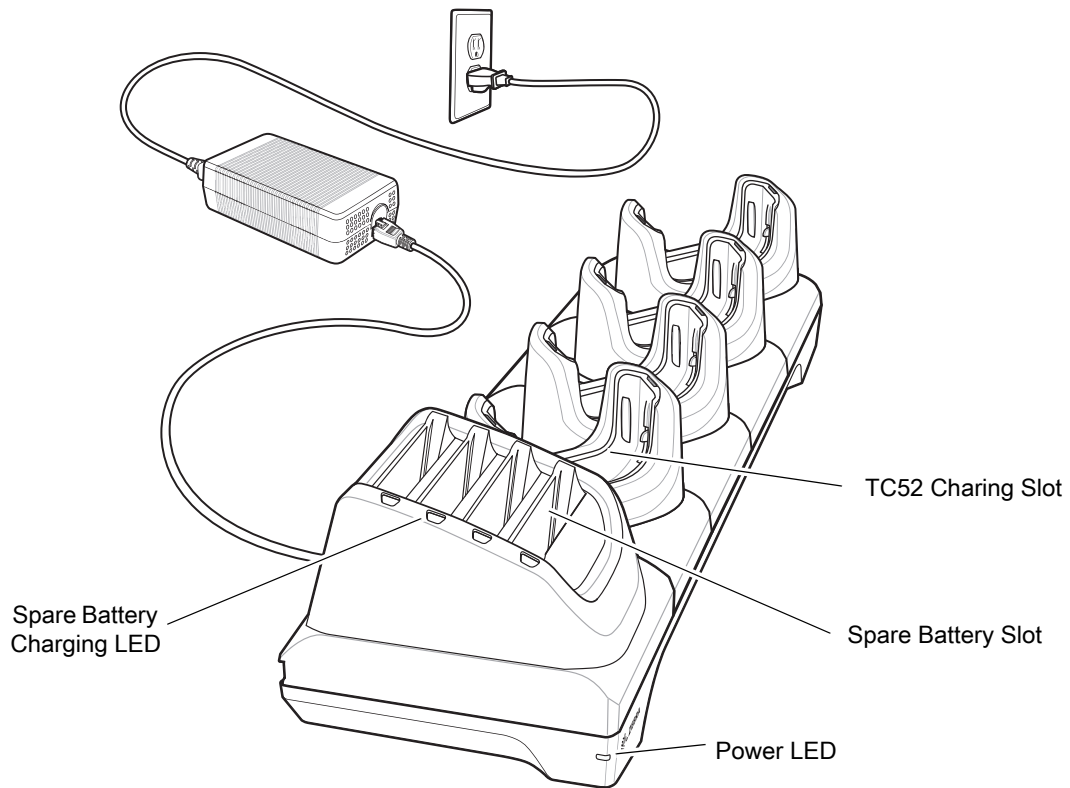

Charging the Device

To charge a device:



NOTE: If the device has a Rugged Boot, remove the cup insert before inserting the device. See Integrator Guide for details.

1. Insert the device into a slot to begin charging.

Figure 121 Device Battery Charging

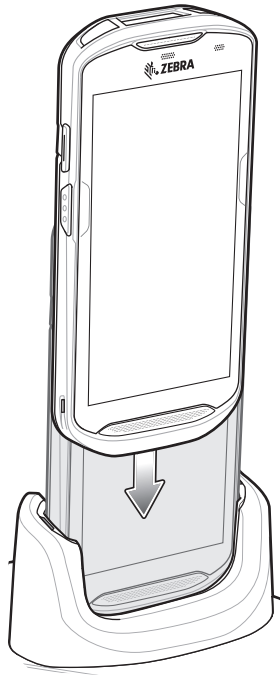
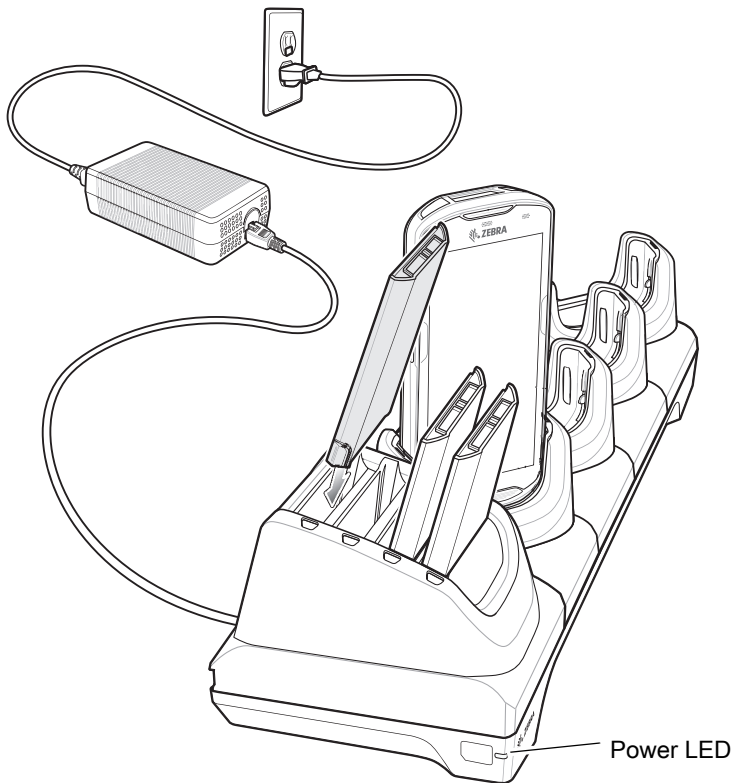

Figure 122 Spare Battery Charging



2. Ensure the device is seated properly.



NOTE: See the Integrator Guide for information on installing the 4-Slot Battery Charger onto the cradle.

Inserting a TC52 with Rugged Boot into Cradle

Each cradle cup has an insert that must be removed prior to inserting the device with Rugged Boot. Remove the insert and then insert the device into the cup.

Figure 123 Remove Insert from Cup

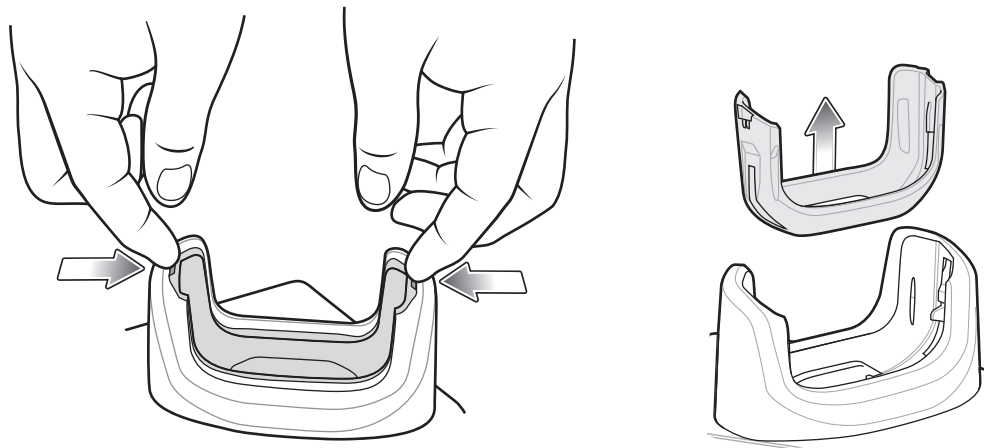

Battery Charging

Main Battery Charging

The device's Charging/Notification LED indicates the status of the battery charging in the device. See [Table 3 on page 21](#) for device charging status. The battery charges from fully depleted to 90% in approximately 2.5 hours and from fully depleted to 100% in approximately three hours.



NOTE: In many cases the 90% charge provides plenty of charge for daily use. A full 100% charge lasts for approximately 14 hours of use.

To achieve the best fast charging results use only Zebra charging accessories and batteries. Charge batteries at room temperature with the device in sleep mode.

Spare Battery Charging







The Spare Battery Charging LED on the cup indicates the status of the spare battery charging. The battery charges from fully depleted to 90% in approximately 2.3 hours and from fully depleted to 100% in approximately three hours.



NOTE: In many cases the 90% charge provides plenty of charge for daily use. A full 100% charge lasts for approximately 14 hours of use.

To achieve the best fast charging results use only Zebra charging accessories and batteries.

Table 14 Spare Battery LED Charging Indicators

LED	LED	Indication
Solid amber		Spare battery is charging.
Solid amber with alternate bright amber		Best spare battery is charging.
Solid Green		Spare battery charging is complete.
Solid Green with alternate bright green		Best spare battery charging is complete.
Solid Red		Spare battery is charging and battery is at the end of useful life. Charging complete and battery is at the end of useful life.
Fast Blinking Red (2 blinks/second)		Error in charging; check placement of spare battery and battery is at the end of useful life.
Off		No spare battery in slot. Spare battery not placed in slot correctly. Cradle is not powered.

Charging Temperature

Charge batteries in temperatures from 5°C to 40°C (41°F to 104°F). The device or cradle always performs battery charging in a safe and intelligent manner. At higher temperatures (e.g. approximately +37°C (+98°F)) the device or cradle may for small periods of time alternately enable and disable battery charging to keep the battery at acceptable temperatures. The device and cradle indicates when charging is disabled due to abnormal temperatures via its LED.

5-Slot Charge Only Cradle



CAUTION: Ensure that you follow the guidelines for battery safety described in [Battery Safety Guidelines on page 180](#).

The 5-Slot Charge Only Cradle:

- Provides 5 VDC power for operating the device.
- Simultaneously charges up to five devices.

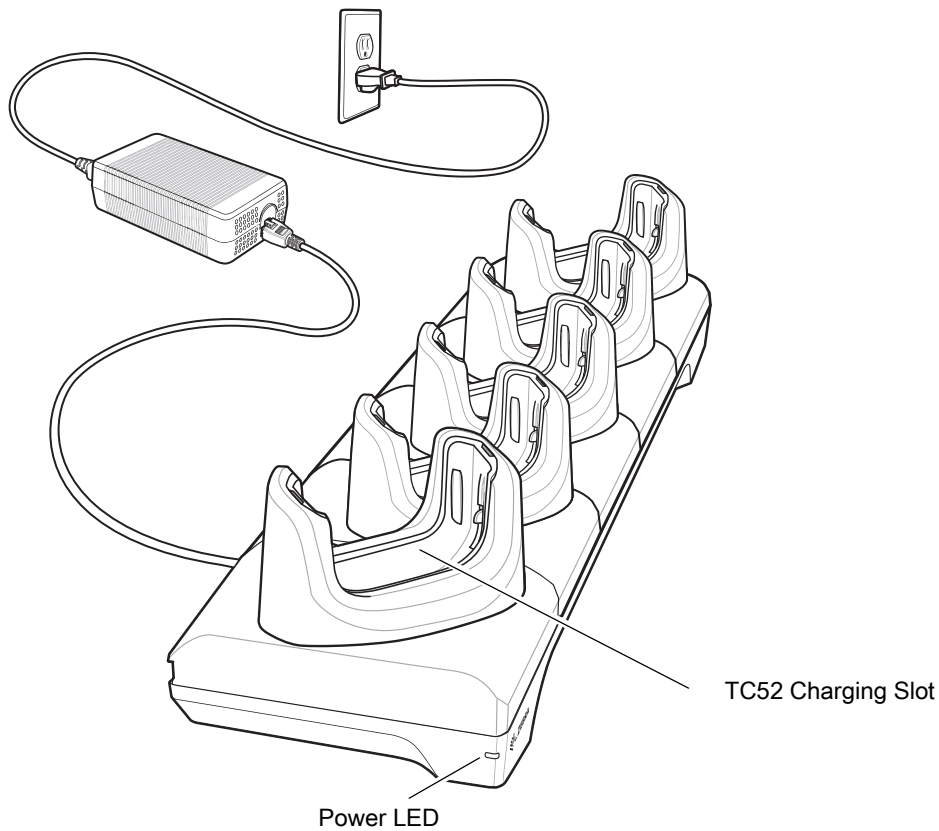
Figure 124 5-Slot Charge Only Cradle

Charging the Device

To charge a device:



NOTE: If the device has a Rugged Boot, remove the cup insert before inserting the device. See TC52 Touch Computer Integrator Guide for Android 8 Oreo for details.

1. Insert the device into a slot to begin charging.

Figure 125 TC52 Battery Charging

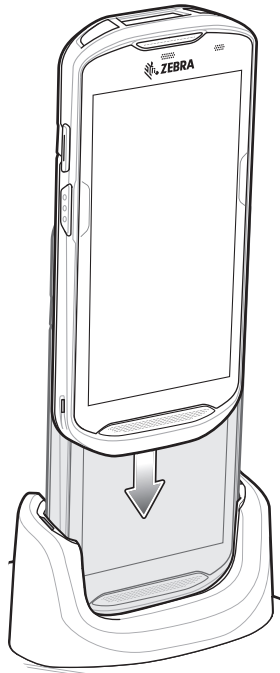

2. Ensure the device is seated properly.



NOTE: See the Integrator Guide for Android 8.1 Oreo for information on installing the 4-Slot Battery Charger onto the cradle.

Inserting a Device with Rugged Boot into Cradle

Each cradle cup has an insert that must be removed prior to inserting the device with Rugged Boot. Remove the insert and then insert the device into the cup.

Figure 126 Remove Insert from Cup

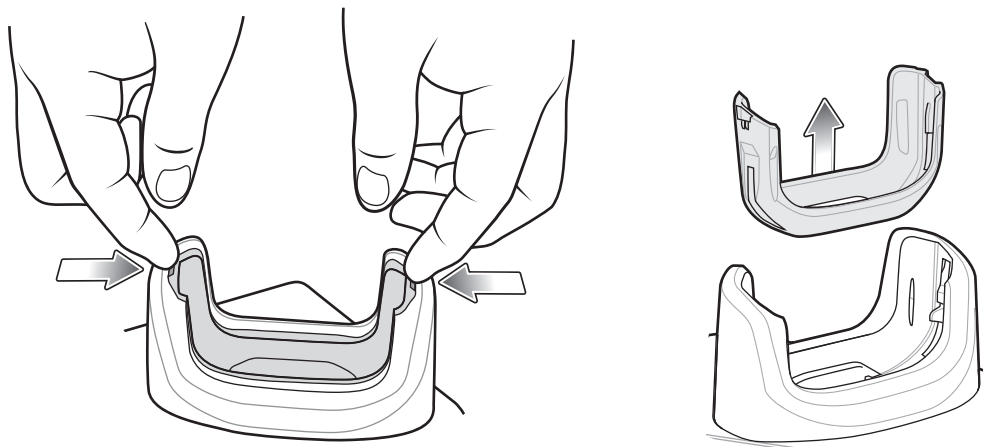

Battery Charging

Main Battery Charging

The device's Charging/Notification LED indicates the status of the battery charging in the device. See [Table 3 on page 21](#) for device charging status. The battery charges from fully depleted to 90% in approximately 2.5 hours and from fully depleted to 100% in approximately three hours.



NOTE: In many cases the 90% charge provides plenty of charge for daily use. A full 100% charge lasts for approximately 14 hours of use.

To achieve the best fast charging results use only Zebra charging accessories and batteries. Charge batteries at room temperature with the device in sleep mode.

Charging Temperature

Charge batteries in temperatures from 5°C to 40°C (41°F to 104°F). The device or cradle always performs battery charging in a safe and intelligent manner. At higher temperatures (e.g. approximately +37°C (+98°F)) the device or cradle may for small periods of time alternately enable and disable battery charging to keep the battery at acceptable temperatures. The device and cradle indicates when charging is disabled due to abnormal temperatures via its LED.

5-Slot Ethernet Cradle



CAUTION: Ensure that you follow the guidelines for battery safety described in [Battery Safety Guidelines on page 180](#).

The 5-Slot Ethernet Cradle:

- Provides 5 VDC power for operating the device.
- Connects the device (up to five) to an Ethernet network.
- Simultaneously charges up to five devices.

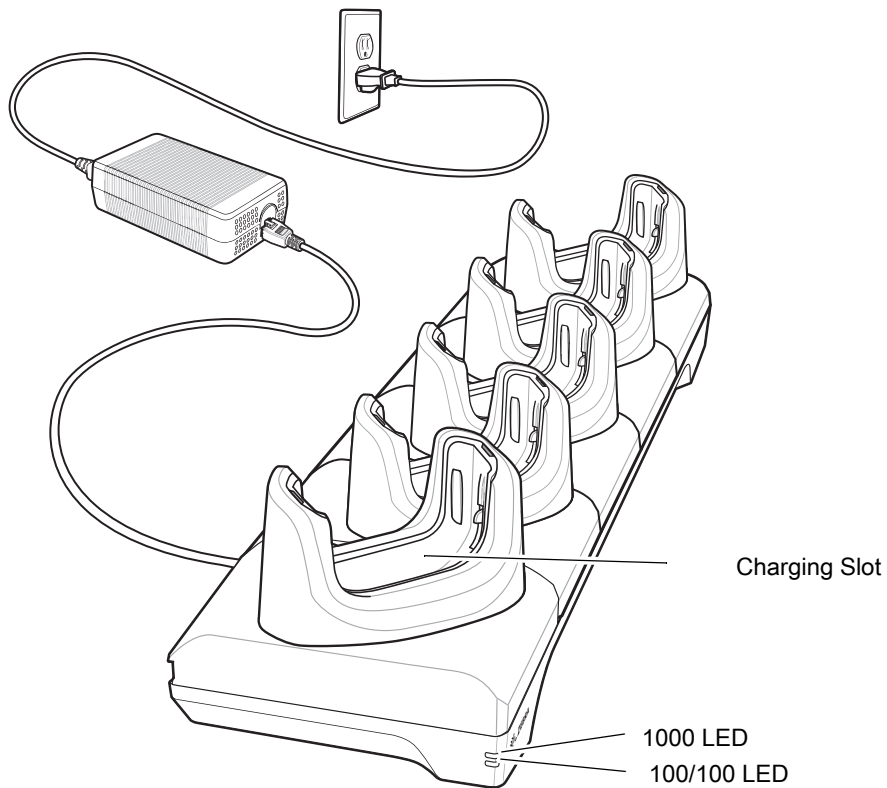
Figure 127 5-Slot Ethernet Cradle

Charging the Device

To charge a device:



NOTE: If the device has a Rugged Boot, remove the cup insert before inserting the device. See TC52 Touch Computer Integrator Guide for Android 8 Oreo for details.

1. Insert the device into a slot to begin charging.

Figure 128 TC52 Battery Charging

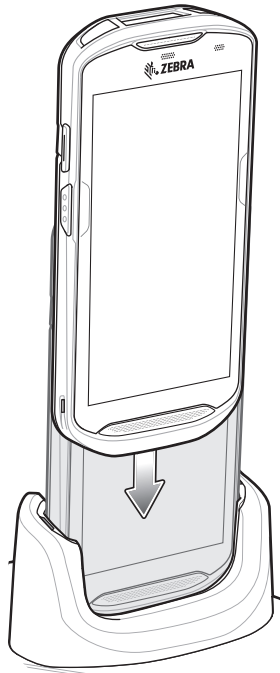

2. Ensure the device is seated properly.

Inserting a TC52 with Rugged Boot into Cradle

Each cradle cup has an insert that must be removed prior to inserting the device with Rugged Boot. Remove the insert and then insert the device into the cup.

Figure 129 Remove Insert from Cup

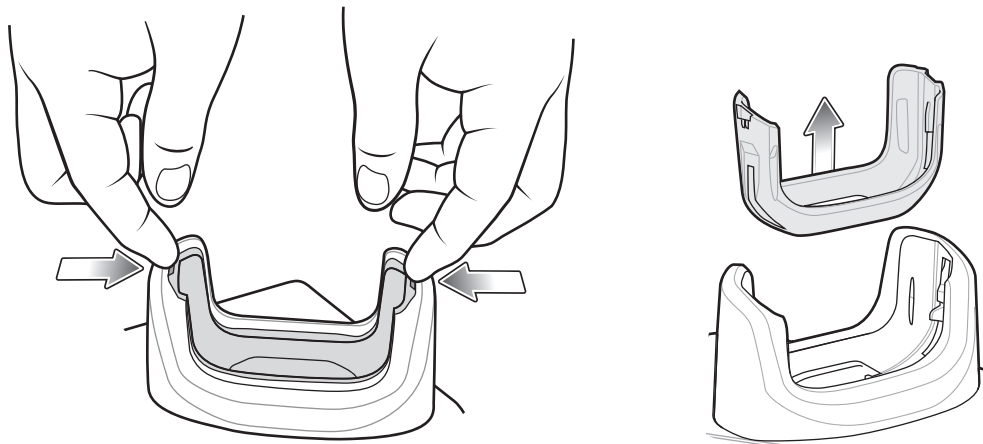

Battery Charging

Main Battery Charging

The device's Charging/Notification LED indicates the status of the battery charging in the device. See [Table 3 on page 21](#) for device charging status. The battery charges from fully depleted to 90% in approximately 2.5 hours and from fully depleted to 100% in approximately three hours.



NOTE: In many cases the 90% charge provides plenty of charge for daily use. A full 100% charge lasts for approximately 14 hours of use.

To achieve the best fast charging results use only Zebra charging accessories and batteries. Charge batteries at room temperature with the device in sleep mode.



Charging Temperature

Charge batteries in temperatures from 5°C to 40°C (41°F to 104°F). The device or cradle always performs battery charging in a safe and intelligent manner. At higher temperatures (e.g. approximately +37°C (+98°F)) the device or cradle may for small periods of time alternately enable and disable battery charging to keep the battery at acceptable temperatures. The device and cradle indicates when charging is disabled due to abnormal temperatures via its LED.

Establishing Ethernet Connection



NOTE: Refer to the TC52 Touch Computer Integrator Guide for Android 8 Oreo for information on configuring the Ethernet settings.

1. Swipe down with two fingers from the status bar to open the quick access panel and then touch .
2. Touch **Ethernet**.
3. Slide the Ethernet switch to the **ON** position.
4. Insert the device into a slot.
The  icon appears in the Status bar.
5. Touch **Eth0** to view Ethernet connection details.

LED Indicators

There are two green LEDs on the side of the cradle. These green LEDs light and blink to indicate the data transfer rate.

Table 15 LED Data Rate Indicators

Data Rate	1000 LED	100/10 LED
1 Gbps	On/Blink	Off
100 Mbps	Off	On/Blink
10 Mbps	Off	On/Blink

4-Slot Battery Charger



CAUTION: Ensure that you follow the guidelines for battery safety described in [Battery Safety Guidelines on page 180](#).

This section describes how to use the 4-Slot Battery Charger to charge up to four device batteries.

Charging Spare Batteries

1. Connect the charger to a power source.
2. Insert the battery into a battery charging well and gently press down on the battery to ensure proper contact.

Figure 130 4-Slot Battery Charger

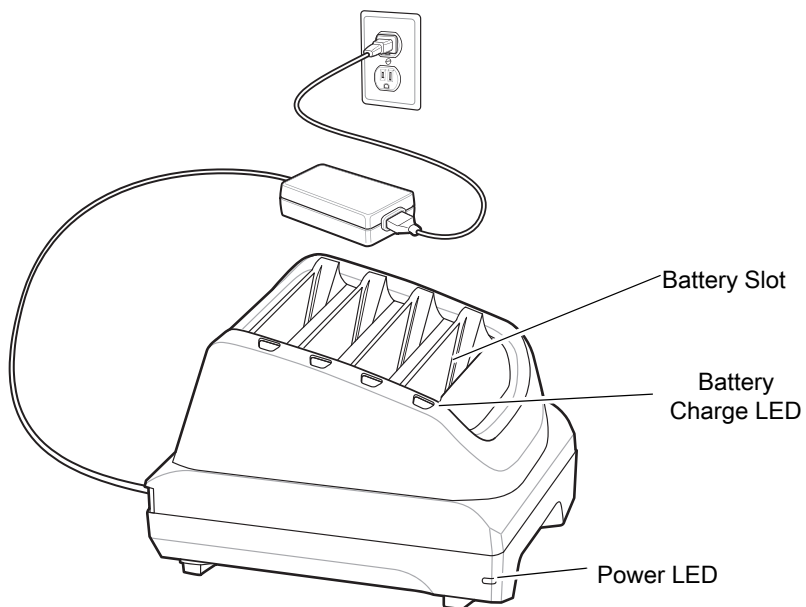

Battery Charging

Spare Battery Charging

Figure 131 Insert Battery into Charger

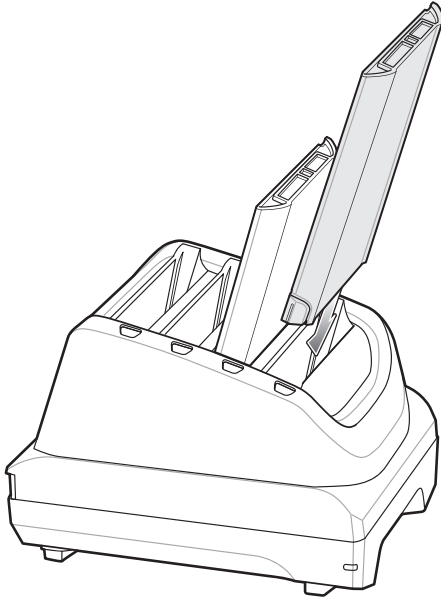

Each Battery Charging LED indicates the status of the battery charging in each slot. See Table 14 on page 151 for spare battery charging indicator descriptions.

The 4,150 mAh (typical) / 3,840 mAh (minimum) battery charges from fully depleted to 90% in approximately 2.3 hours and from fully depleted to 100% in approximately three hours.



NOTE: In many cases the 90% charge provides plenty of charge for daily use. A full 100% charge lasts for approximately 14 hours of use.

To achieve the best fast charging results use only Zebra charging accessories and batteries.

Charging Temperature

Charge batteries in temperatures from 5°C to 40°C (41°F to 104°F). The device or cradle always performs battery charging in a safe and intelligent manner. At higher temperatures (e.g. approximately +37°C (+98°F)) the device or cradle may for small periods of time alternately enable and disable battery charging to keep the battery at acceptable temperatures. The device and cradle indicates when charging is disabled due to abnormal temperatures via its LED.

Rugged Boot

The Rugged Boot provides additional protection for the device.

Installation

To install the Rugged Boot:

1. Insert the bottom of the device into the bottom of the boot.

Figure 132 Insert Device into Boot

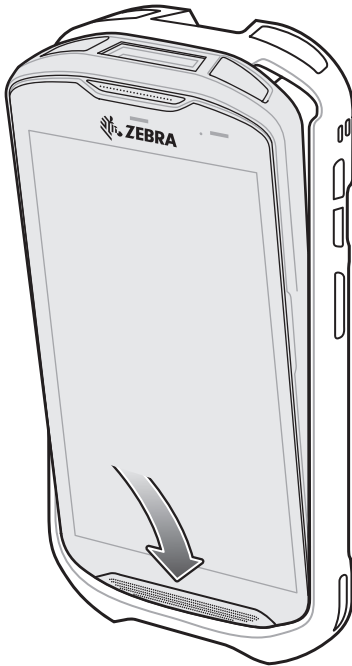

2. Lift the top of the Rugged Boot over the top of the device.

Figure 133 Lift Boot Over Device

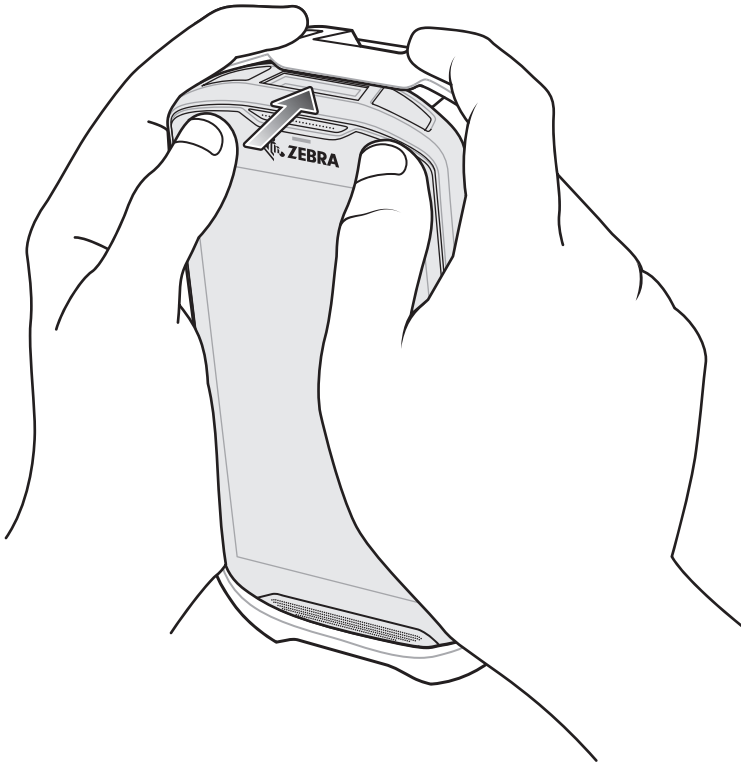

3. Push the device into the Rugged Boot.

Figure 134 Push Device into Boot

Installing Stylus

To install the optional stylus:

1. Insert one of the loop ends of the tether through the hole in the stylus.
2. Feed the tether through the loop.
3. Pull the tether until the loop tightens.
4. Insert the loop into the hand strap holder.
5. Feed the stylus through the loop.

Figure 135 Install Tether to Stylus

Figure 136 Install Stylus on Hand Strap

Charging with Cradles

Before inserting the device with the Rugged Boot into the cradle cup, remove the insert from the cup.

1. Using index fingers on both hands, push the insert toward the center of the cup.

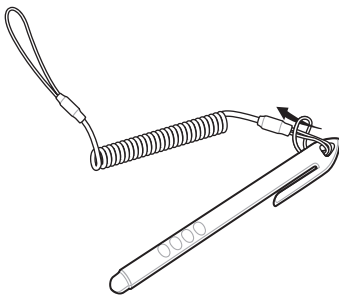
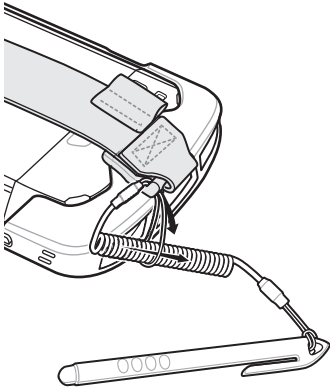
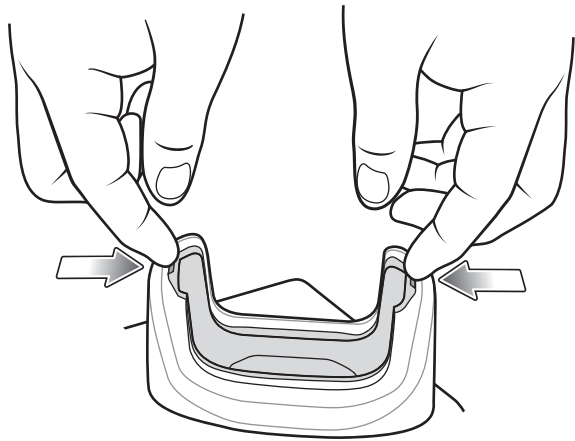
Figure 137 Pull Insert Toward Center

2. Lift insert out of cup.

Figure 138 Lift Insert Out of Cup

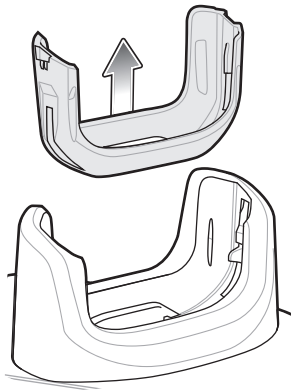

3. Insert the device into the cradle.

Figure 139 Insert Device with Boot into Cradle Cup

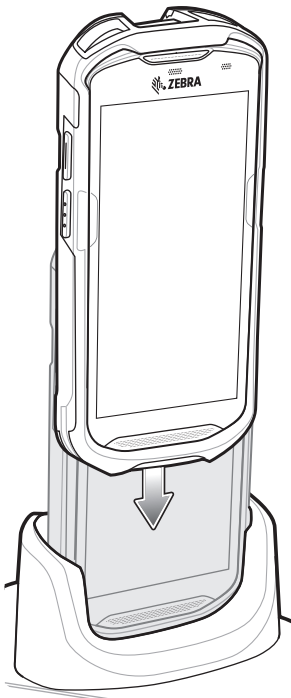

Basic Hand Strap Kit

Use to Basic Hand Strap Kit to add a hand strap to the device.

Figure 140 Basic Hand Strap Kit

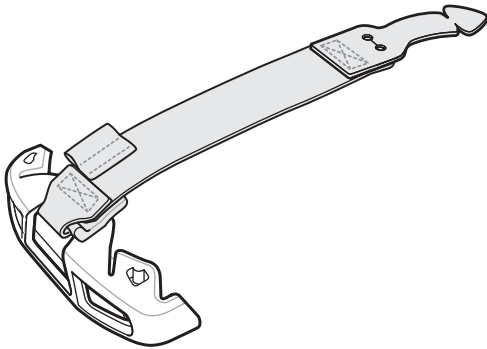

Installation

To install the Basic Hand Strap Kit:

1. Remove the two rubber plugs on the back of the device.

Figure 141 Remove Plugs

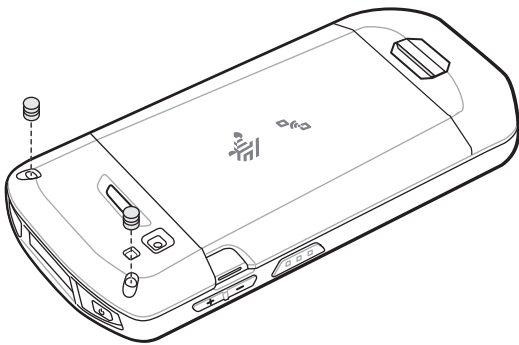

2. Align the top cap onto the device.
3. Rotate the top cap over the top of the device.

Figure 142 Rotate Top Cap Cover Top of Device

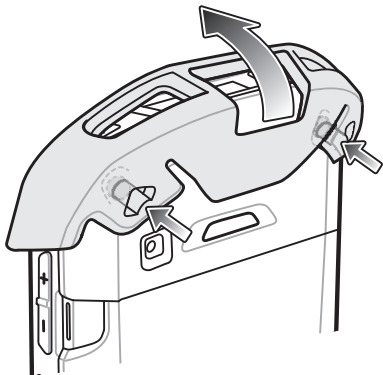

4. Insert the tab end of the hand strap into the slot on the device.

Figure 143 Insert Hand Strap Tab into Slot

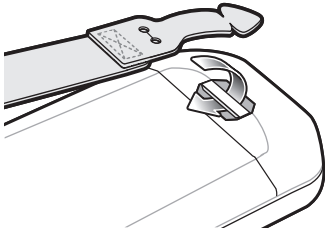

5. Feed the tab into the cut in the strap.

Figure 144 Feed Tab into Slot

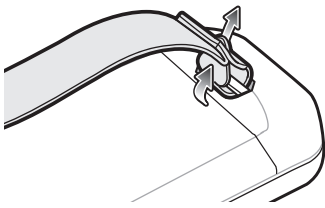

6. Align the hand strap clip with the top cap.

Figure 145 Install Hand Strap Clip onto Top Cap

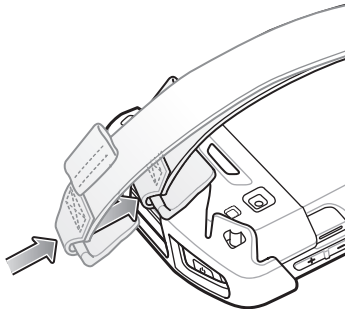

7. Push the clip onto the top cap.

Removal

To remove the Basic Hand Strap Kit:

1. Using thumbs, push the top cap up and rotate over the top of the device.

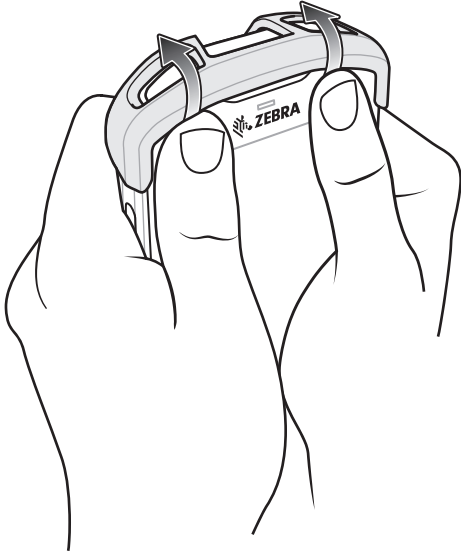
Figure 146 Remove Top Cap

2. Pull the strap tab through the cut slot.
3. Pull the Hand Strap tab through the slot in the device.

2.5 mm Audio Adapter



NOTE: The Audio Adapter is available for the device standard configuration.

The 2.5 mm Audio Adapter plugs into the device and connects to a wired headset with a 2.5 mm plug.

To attach a 2.5 mm headset:

1. Open the headset jack cover.
2. Insert the 2.5 mm Audio Adapter plug into the headset jack.

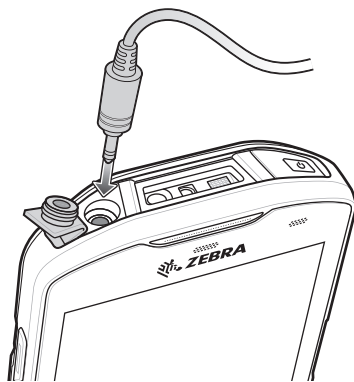
Figure 147 Audio Adapter Installation

3. Insert the 2.5 mm headset plug into the jack on the Audio Adapter.

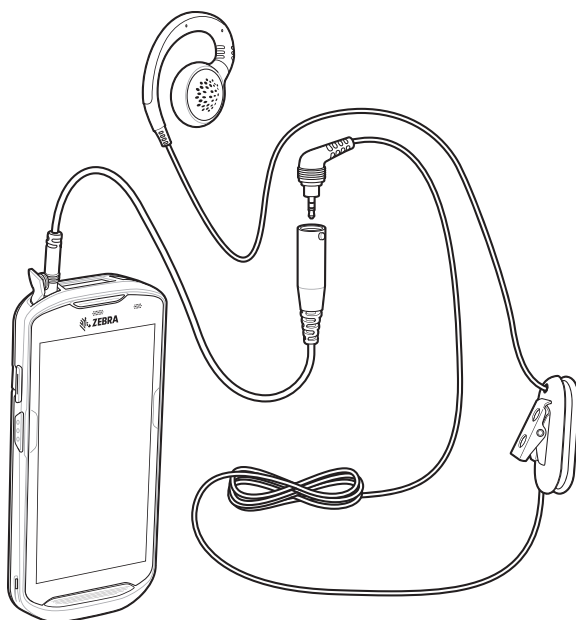
Figure 148 Connect Headset to Audio Adapter

CAUTION: After removing headset, headset jack cover must be replaced and securely seated to ensure proper device sealing.

3.5 mm Audio Adapter



NOTE: The Audio Adapter is available for the device standard configuration.

The 3.5 mm Audio Adapter plugs into the device and connects to a wired headset with a 3.5 mm plug.

To attach a 3.5 mm headset:

1. Open the headset jack cover.
2. Insert the 3.5 mm Audio Adapter plug into the headset jack.

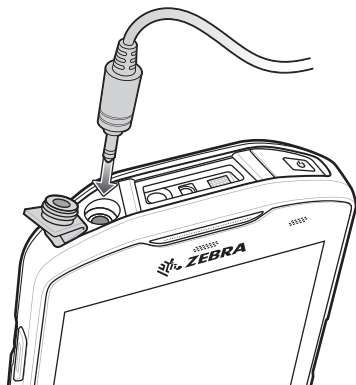
Figure 149 Audio Adapter Installation

3. Connect the 3.5 mm connector plug of the headset into the 3.5 mm Audio Adapter.

Figure 150 Connect Headset to 3.5 mm Adapter Cable

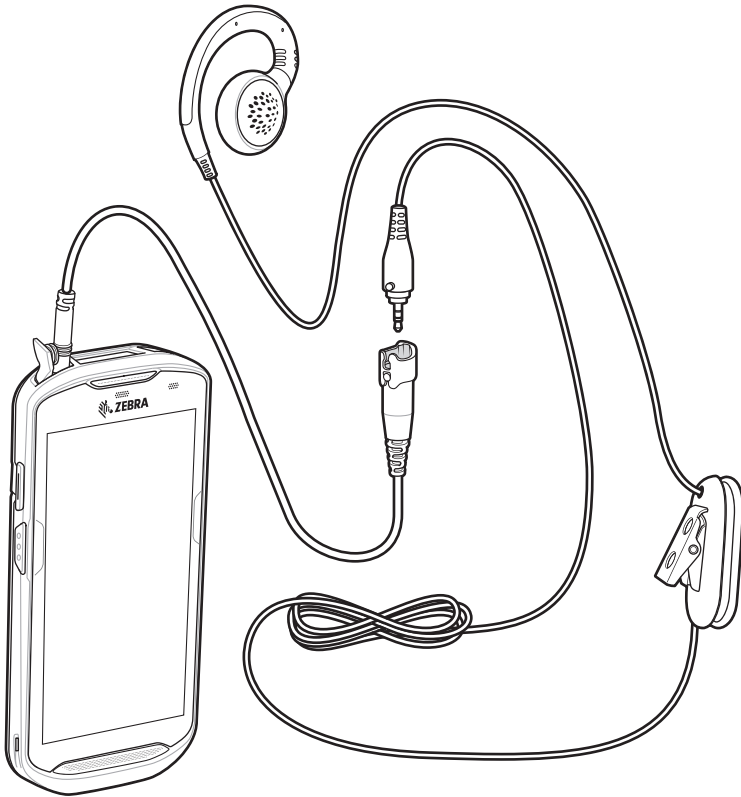

CAUTION: After removing headset, headset jack cover must be replaced and securely seated to ensure proper device sealing.

Rugged Charge/USB Cable

The Rugged Charge/USB Cable snaps onto the bottom of the device and removes easily when not in use. When attached to the device allows charging and allows the device to transfer data to a host computer.

Figure 151 Rugged Charge/USB Cable

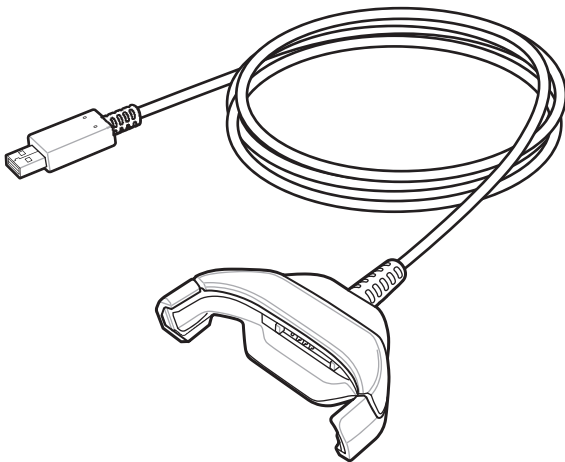

Connecting to TC52

1. Insert the device at an angle into the cable cup until the device touches the bottom of the cup.

Figure 152 Device Into Cable Cup

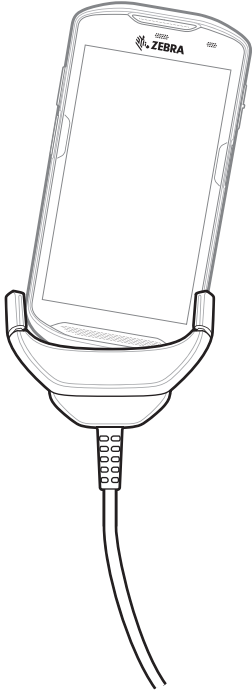

2. Rotate the device into the cup.

Figure 153 Rotate Device into Cable Cup

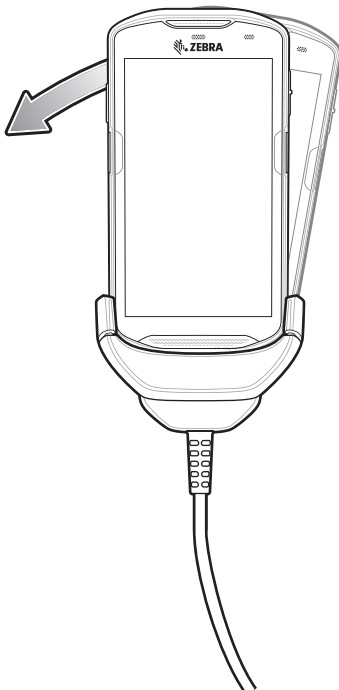

Connecting to TC52 with Rugged Boot

To connect the Rugged Charge/USB Cable to a device with a Rugged Boot:

1. Using thumb and index finger, squeeze the sides of the cup in.

Figure 154 Remove Cable Cup Insert

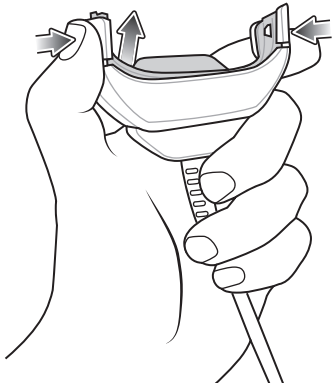

2. Lift insert out of cup.

Figure 155 Cable Installation

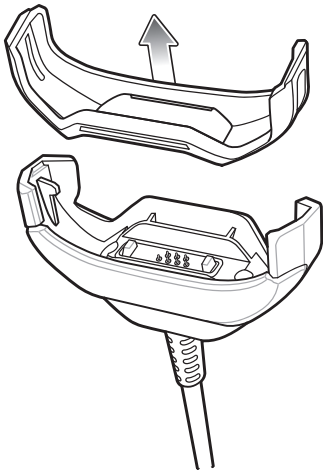

3. Align the cable cup with the bottom of the device.
4. Press the device into the cable cup until it securely in place.

USB Communication

To connect the device to a host computer:

1. Connect the Rugged Charge/USB Cable to the device.
2. Connect the USB connector of the cable to a host computer.

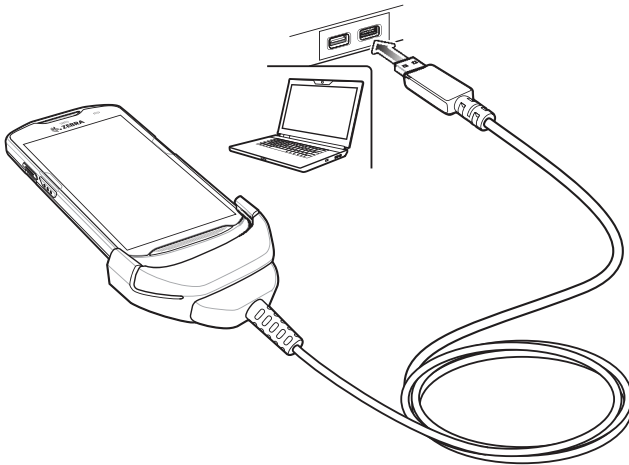
Figure 156 Rugged Charge/USB Cable to Host Computer

Charging the Device

To charge the device using the Rugged Charge/USB Cable:

1. Connect the Rugged Charge/USB Cable to the device.
2. Connect the USB connector of the power supply.



NOTE: See Power Supply on page 177 for information on setting up the power supply.

By default, the device includes an interface connector. If the interface connector is removed for USB Type C cable connectivity, then it must be replaced before charging or receiving an Ethernet IP address if placed in a cradle.

3. Plug to power supply into an power outlet.

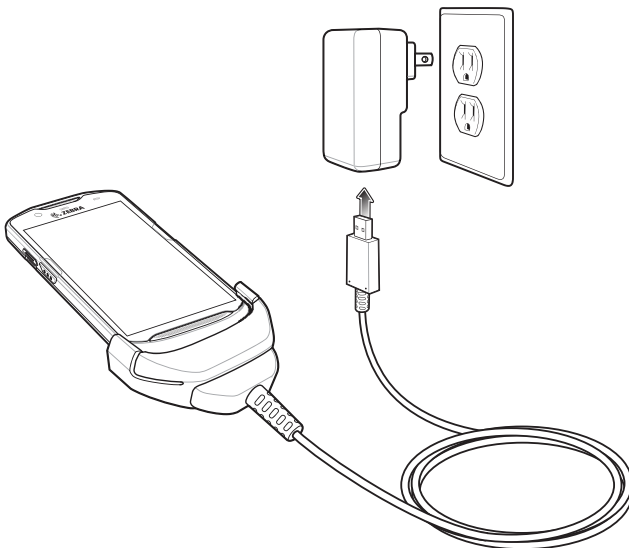
Figure 157 Charging Using the Rugged Charge/USB Cable

Disconnecting the Rugged Charge/USB Cable

To disconnect the Rugged Charge/USB Cable from the device:

1. Rotate the device to one side.

Figure 158 Remove Device from Rugged Charge/USB Cable

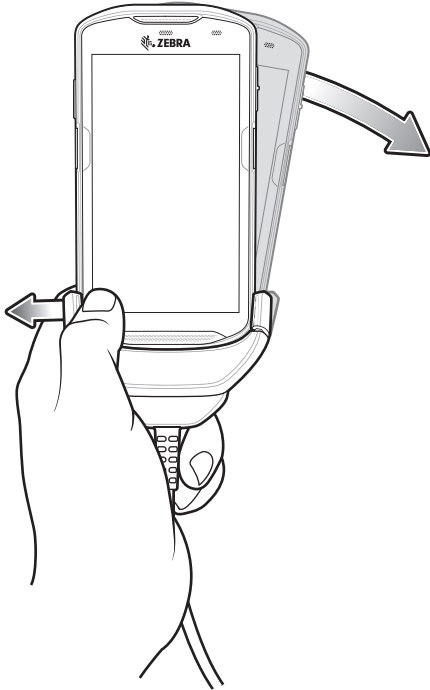

2. Push the Rugged Charge/USB Cable to the other side.
3. Remove the device from the Rugged Charge/USB Cable.

Battery Charging

Main Battery Charging

The device's Charging/Notification LED indicates the status of the battery charging in the device. See [Table 3 on page 21](#) for device charging status. The battery charges from fully depleted to 90% in approximately 2.5 hours and from fully depleted to 100% in approximately three hours.



NOTE: In many cases the 90% charge provides plenty of charge for daily use. A full 100% charge lasts for approximately 14 hours of use.

To achieve the best fast charging results use only Zebra charging accessories and batteries. Charge batteries at room temperature with the device in sleep mode.

Charging Temperature

Charge batteries in temperatures from 5°C to 40°C (41°F to 104°F). The device or cradle always performs battery charging in a safe and intelligent manner. At higher temperatures (e.g. approximately +37°C (+98°F)) the device or cradle may for small periods of time alternately enable and disable battery charging to keep the battery at acceptable temperatures. The device and cradle indicates when charging is disabled due to abnormal temperatures via its LED.

Trigger Handle

NOTE: The Rugged Boot is required to install the Trigger Handle onto the device. Trigger Handle (p/n TRG-TC51-SNP1-01)

does not contain the Rugged Boot and must be purchased separately. Trigger Handle Kit (p/n TRG-TC51-TRG1-01) contains the Rugged Boot.

The Trigger Handle adds a gun-style handle with a scanning trigger to the device. It increases comfort when using the device in scan-intensive applications for extended periods of time.

Figure 159 Trigger Handle

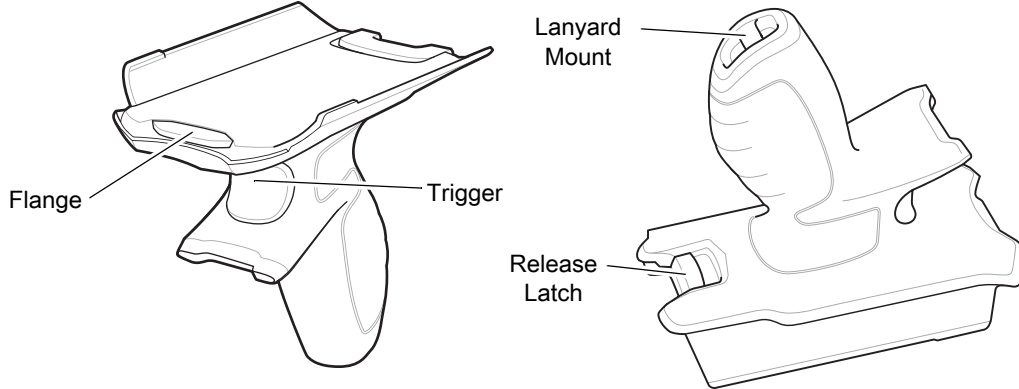

Installing the Rugged Boot



NOTE: If a Hand Strap is attached to the Rugged Boot, remove prior to installing onto device.

To install the Rugged Boot:

1. Insert the bottom of the device into the bottom of the boot.

Figure 160 Insert Device into Boot

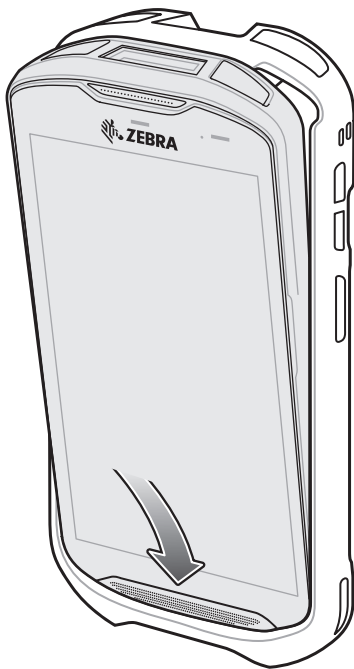

2. Lift the top of the Rugged Boot over the top of the device.

Figure 161 Lift Boot Over Device



3. Push the device into the Rugged Boot.

Figure 162 Push Device into Boot

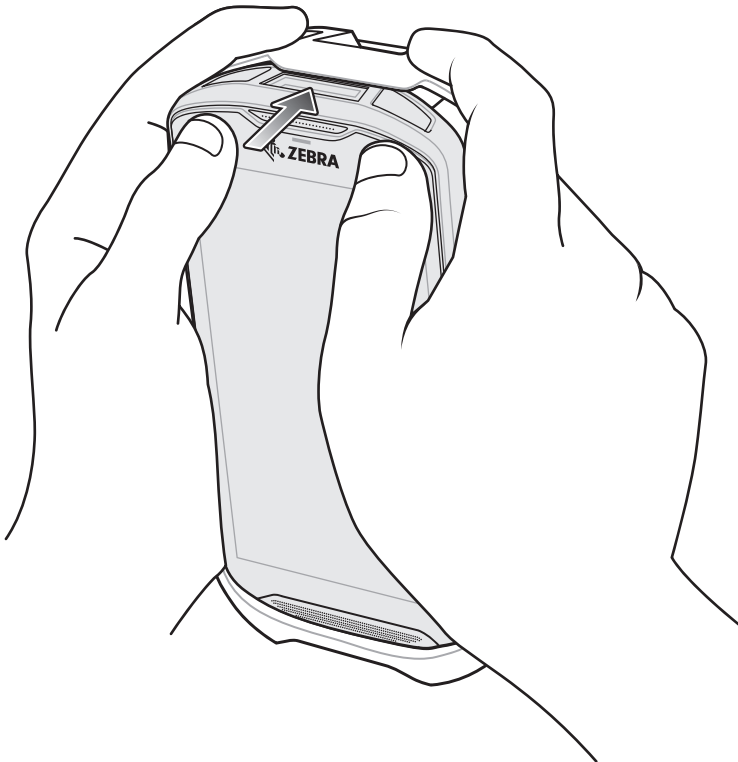

Installing the Optional Lanyard

To install the lanyard onto the Trigger Handle:

1. Insert the loop end of the tether into the slot on the bottom of the handle.
2. Feed the lanyard through the loop.

Figure 163 Install Attachment Plate to Handle

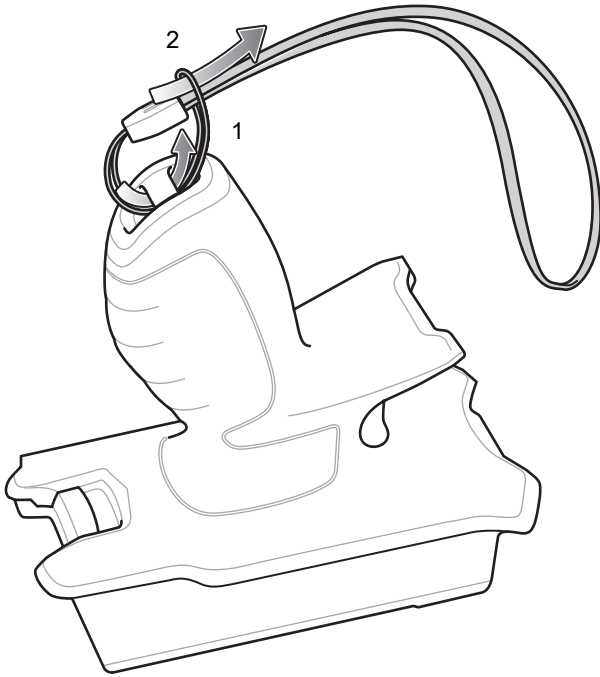

3. Pull the lanyard until the loop tightens.

Inserting the Device into the Trigger Handle

To install the device onto the Trigger handle:

1. Align and insert the flange of the Trigger Handle with the top of the Rugged Boot.

Figure 164 Connect Device to Trigger Handle

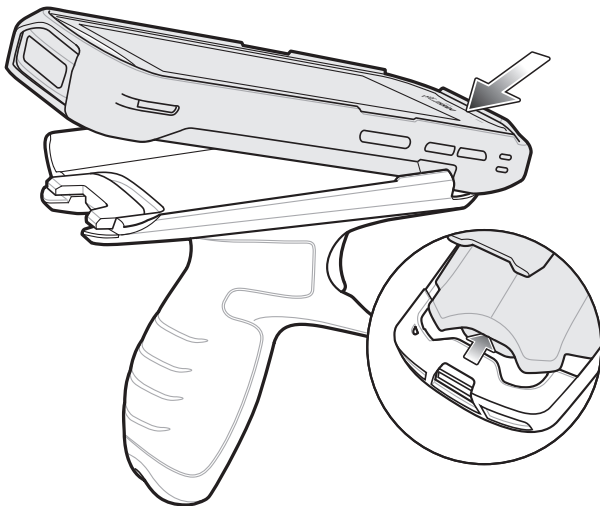

2. Rotate the device down and press down until it snaps into place.

Figure 165 Rotate Device onto Trigger Handle



Removing the Device from the Trigger Handle

To remove the device from the Trigger Handle:

1. Press Trigger Handle release latch.

Figure 166 Press Release Latches

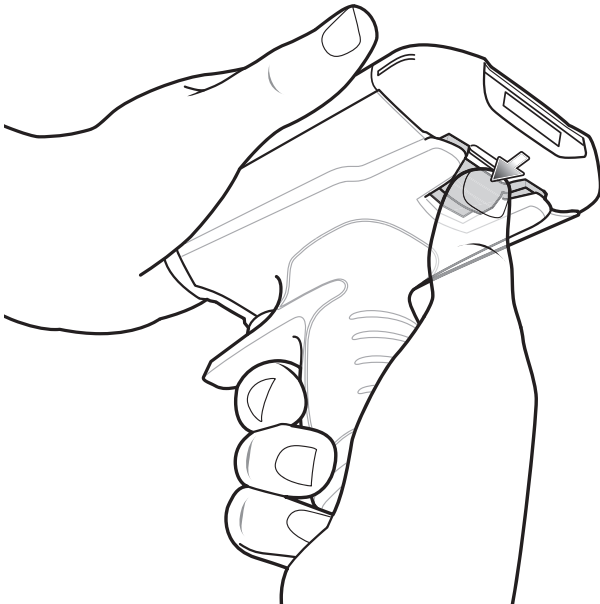

2. Slide the device forward and then rotate the bottom of the device up.

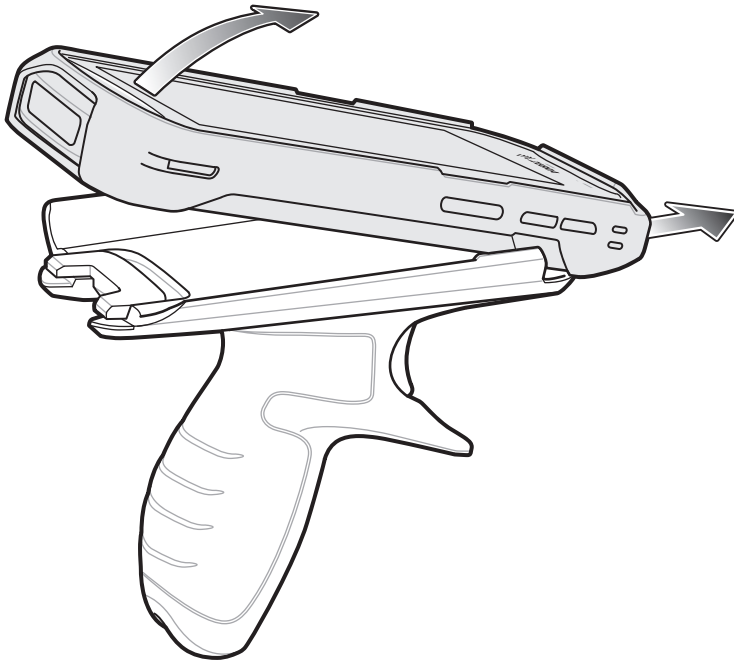
Figure 167 Remove Device from Trigger Handle

Power Supply

Use the power supply with the Rugged Charge/USB Cable to charge the device. The power supply comes in various configuration with different plug adapters for use internationally. To change the plug adapters:

1. Pull the release button down.

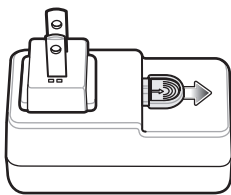
Figure 168 Pull Release Button

2. Rotate the plug adapter up and out of the power supply.

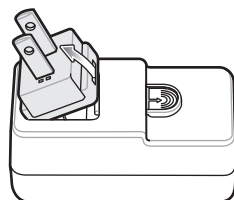
Figure 169 Lift Plug Adapter

3. Insert the replace plug adapter into the power supply.

Figure 170 Insert Plug Adapter

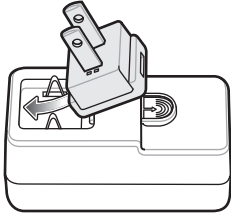

4. Rotate the plug adapter down and snap into place.

Figure 171 Rotate Plug Adapter in Power Supply

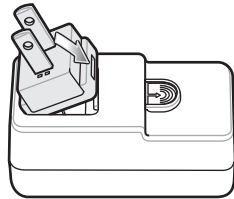

Maintenance and Troubleshooting

Introduction

This chapter includes instructions on cleaning and storing the device, and provides troubleshooting solutions for potential problems during operation.

Maintaining the Device

For trouble-free service, observe the following tips when using the device:

- In order to avoid scratching the screen, use the supplied stylus or plastic-tipped pens intended for use with a touch-sensitive screen. Never use an actual pen or pencil or other sharp object on the surface of the device screen.
- The touch-sensitive screen of the device is glass. Do not drop the device or subject it to strong impact.
- Protect the device from temperature extremes. Do not leave it on the dashboard of a car on a hot day, and keep it away from heat sources.
- Do not store the device in any location that is dusty, damp, or wet.
- Use a soft lens cloth to clean the device. If the surface of the device screen becomes soiled, clean it with a soft cloth moistened with an approved cleanser. For a list of approved cleansers, see Approved Cleanser Active Ingredients on page 181.
- Periodically replace the rechargeable battery to ensure maximum battery life and product performance. Battery life depends on individual usage patterns.

Display Best Practices

Image Retention

Image retention may occur when a static image continuously displays for extended periods of time. A user may see a faint remnant of the image even after a new image displays. To prevent image retention:

- set the display to turn off after a few minutes of idle time.
- rotate background images on a periodic basis.
- turn off the display when the device is not in use.

- use a screen saver with the following characteristics:
 - background color set to black
 - use a small moving image (approximately 2% of the display size).
 - move the image randomly across the screen
 - screen saver should be active as long as the static image is used.

Battery Safety Guidelines

The area in which the units are charged should be clear of debris and combustible materials or chemicals. Particular care should be taken where the device is charged in a non-commercial environment.

- Follow battery usage, storage, and charging guidelines found in the user's guide.
- Improper battery use may result in a fire, explosion, or other hazard.
- To charge the mobile device battery, the battery and charger temperatures must be between +41°F and +104°F (5°C and +40°C).
- Do not use incompatible batteries and chargers. Use of an incompatible battery or charger may present a risk of fire, explosion, leakage, or other hazard. If you have any questions about the compatibility of a battery or a charger, contact Zebra support.
- For devices that utilize a USB port as a charging source, the device shall only be connected to products that bear the USB-IF logo or have completed the USB-IF compliance program.
- Do not disassemble or open, crush, bend or deform, puncture, or shred.
- Severe impact from dropping any battery-operated device on a hard surface could cause the battery to overheat.
- Do not short circuit a battery or allow metallic or conductive objects to contact the battery terminals.
- Do not modify or remanufacture, attempt to insert foreign objects into the battery, immerse or expose to water or other liquids, or expose to fire, explosion, or other hazard.
- Do not leave or store the equipment in or near areas that might get very hot, such as in a parked vehicle or near a radiator or other heat source. Do not place battery into a microwave oven or dryer.
- Battery usage by children should be supervised.
- Please follow local regulations to promptly dispose of used re-chargeable batteries.
- Do not dispose of batteries in fire.
- Seek medical advice immediately if a battery has been swallowed.
- In the event of a battery leak, do not allow the liquid to come in contact with the skin or eyes. If contact has been made, wash the affected area with large amounts of water and seek medical advice.
- If you suspect damage to your equipment or battery, contact Zebra support to arrange for inspection.

Cleaning Instructions



CAUTION: Always wear eye protection.

Read warning label on alcohol product before using.

If you have to use any other solution for medical reasons please contact the Global Customer Support Center for more information.



WARNING: Avoid exposing this product to contact with hot oil or other flammable liquids. If such exposure occurs, unplug the device and clean the product immediately in accordance with these guidelines.

Approved Cleanser Active Ingredients

100% of the active ingredients in any cleaner must consist of one or some combination of the following: isopropyl alcohol, bleach/sodium hypochlorite¹ (see important note below), hydrogen peroxide, ammonium chloride or mild dish soap.



- Use pre-moistened wipes and do not allow liquid cleaner to pool.

¹When using sodium hypochlorite (bleach) based products always follow the manufacturer's recommended instructions: use gloves during application and remove the residue afterwards with a damp alcohol cloth or a cotton swab to avoid prolonged skin contact while handling the device.

Due to the powerful oxidizing nature of sodium hypochlorite the metal surfaces on the device are prone to oxidation (corrosion) when exposed to this chemical in the liquid form (including wipes). In the event that these type of disinfectants come in contact with metal on the device, prompt removal with an alcohol-dampened cloth or cotton swab after the cleaning step is critical.

Harmful Ingredients

The following chemicals are known to damage the plastics on the device and should not come in contact with the device: acetone; ketones; ethers; aromatic and chlorinated hydrocarbons; aqueous or alcoholic alkaline solutions; ethanolamine; toluene; trichloroethylene; benzene; carboic acid and TB-lysoform.

Many vinyl gloves contain phthalate additives, which are often not recommended for medical use and are known to be harmful to the housing of the device.

Device Cleaning Instructions

Do not apply liquid directly to the device. Dampen a soft cloth or use pre-moistened wipes. Do not wrap the device in the cloth or wipe, but gently wipe the unit. Be careful not to let liquid pool around the display window or other places. Allow the unit to air dry before use.



NOTE: For thorough cleaning, it is recommended to first remove all accessory attachments, such as hand straps or cradle cups, from the mobile device and to clean them separately.

Special Cleaning Notes

The device should not be handled while wearing vinyl gloves containing phthalates, or before hands are washed to remove contaminant residue after gloves are removed.

If products containing any of the harmful ingredients listed above are used prior to handling the device, such as hand sanitizer that contain ethanolamine, hands must be completely dry before handling the device to prevent damage to the device.



IMPORTANT: If the battery connectors are exposed to cleaning agents, thoroughly wipe off as much of the chemical as possible and clean with an alcohol wipe. It is also recommended to install the battery in the terminal prior to cleaning and disinfecting the device to help minimize buildup on the connectors.

When using cleaning/disinfectant agents on the device, it is important to follow the directions prescribed by the cleaning/disinfectant agent manufacturer.

Recommended Cleaning Materials

- Alcohol wipes
- Lens tissue
- Cotton-tipped applicators
- Isopropyl alcohol

Cleaning Frequency

The cleaning frequency is at the customer's discretion due to the varied environments in which the mobile devices are used and may be cleaned as frequently as required. When dirt is visible, it is recommended to clean the mobile device to avoid build up of particles which make the device more difficult to clean later on.

For consistency and optimum image capture, it is recommended to clean the camera window periodically especially when used in environments prone to dirt or dust.

Cleaning the Device

Housing

Thoroughly wipe the housing, including all buttons and triggers, using an approved alcohol wipe.

Display

The display can be wiped down with an approved alcohol wipe, but care should be taken not to allow any pooling of liquid around the edges of the display. Immediately dry the display with a soft, non-abrasive cloth to prevent streaking.

Camera and Exit Window

Wipe the camera and exit window periodically with a lens tissue or other material suitable for cleaning optical material such as eyeglasses.

Battery Guide Slots

Insert a cotton-tipped applicator dipped in alcohol into the battery guide rails to clean out debris and then dry with a dry cotton-tipped applicator.

Battery Connector and Locating Magnet Cleaning

To clean the battery connectors and locating magnet:

Figure 172 Battery Connectors and Locating Magnet

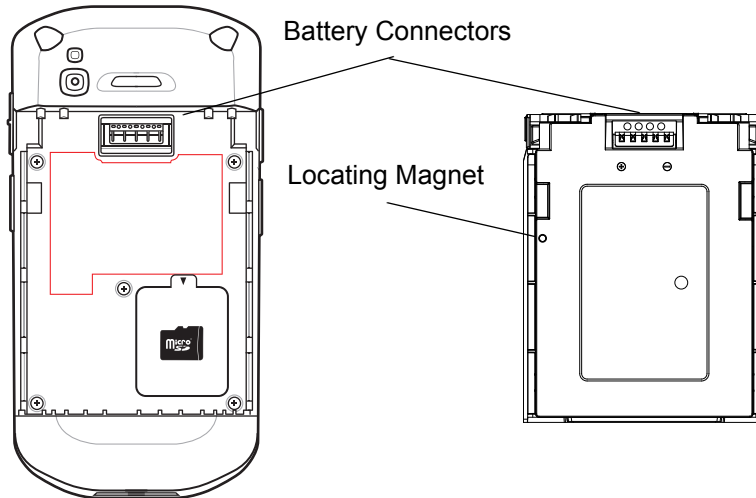

1. Remove the main battery from the mobile computer.
2. Dip the cotton portion of the cotton-tipped applicator in isopropyl alcohol.
3. To remove any grease or dirt, rub the cotton portion of the cotton-tipped applicator back-and-forth across the locating magnet and the connectors on the battery and terminal sides. Do not leave any cotton residue on the connectors or magnet.
4. Repeat at least three times.
5. Use a dry cotton-tipped applicator and repeat steps 3 and 4. Do not leave any cotton residue on the connectors or magnet.
6. Inspect the area for any grease or dirt and repeat the cleaning process if necessary.



CAUTION: After cleaning the battery connectors or locating magnet with bleach-based chemicals, follow the Battery Connector and Locator Magnet Cleaning instructions to remove bleach from the connectors and locating magnet.

Cleaning Cradle Connectors

To clean the connectors on a cradle:

1. Remove the DC power cable from the cradle.
2. Dip the cotton portion of the cotton-tipped applicator in isopropyl alcohol.
3. Rub the cotton portion of the cotton-tipped applicator along the pins of the connector. Slowly move the applicator back-and-forth from one side of the connector to the other. Do not leave any cotton residue on the connector.
4. All sides of the connector should also be rubbed with the cotton-tipped applicator.
5. Remove any lint left by the cotton-tipped applicator.
6. If grease and other dirt can be found on other areas of the cradle, use a lint-free cloth and alcohol to remove.

7. Allow at least 10 to 30 minutes (depending on ambient temperature and humidity) for the alcohol to air dry before applying power to cradle.

If the temperature is low and humidity is high, longer drying time is required. Warm temperature and low humidity requires less drying time.



CAUTION: After cleaning the cradle connectors with bleach-based chemicals, follow the Cleaning Cradle Connectors instructions to remove bleach from the connectors.

Troubleshooting

The following tables provides typical problems that might arise and the solution for correcting the problem.

TC52

Table 16 *Troubleshooting the TC52*

Problem	Cause	Solution
After installing the battery, the device does not boot up.	Power button was not pressed.	Press the Power button.
When pressing the power button the device does not turn on.	Battery not charged.	Charge or replace the battery in the device.
	Battery not installed properly.	Install the battery properly.
	System crash.	Perform a reset.
When pressing the power button the device does not turn on but two LEDs blink.	Battery charge is at a level where data is maintained but battery should be re-charged.	Charge or replace the battery in the device.
Battery did not charge.	Battery failed.	Replace battery. If the device still does not operate, perform a reset.
	Device removed from cradle while battery was charging.	Insert device in cradle. See Charging the Battery on page 21.
	Extreme battery temperature.	Battery does not charge if ambient temperature is below 0°C (32°F) or above 40°C (104°F).
Cannot see characters on display.	Device not powered on.	Press the Power button.

Table 16 *Troubleshooting the TC52 (Continued)*

Problem	Cause	Solution
During data communication with a host computer, no data transmitted, or transmitted data was incomplete.	Device removed from cradle or disconnected from host computer during communication.	Replace the device in the cradle, or reattach the communication cable and re-transmit.
	Incorrect cable configuration.	See the system administrator.
	Communication software was incorrectly installed or configured.	Perform setup.
During data communication over Wi-Fi, no data transmitted, or transmitted data was incomplete.	Wi-Fi radio is not on.	Turn on the Wi-Fi radio.
	You moved out of range of an access point.	Move closer to an access point.
During data communication over Bluetooth, no data transmitted, or transmitted data was incomplete.	Bluetooth radio is not on.	Turn on the Bluetooth radio.
	You moved out of range of another Bluetooth device.	Move within 10 meters (32.8 feet) of the other device.
No sound.	Volume setting is low or turned off.	Adjust the volume.
Device shuts off.	Device is inactive.	The display turns off after a period of inactivity. Set this period to 15 seconds, 30 seconds, 1, 2, 5, 10 or 30 minutes.
	Battery is depleted.	Replace the battery.
Tapping the window buttons or icons does not activate the corresponding feature.	The device is not responding.	Reboot the device.
A message appears stating that the device memory is full.	Too many files stored on the device.	Delete unused memos and records. If necessary, save these records on the host computer (or use an SD card for additional memory).
	Too many applications installed on the device.	Remove user-installed applications on the device to recover memory. Select Settings > Apps & notifications . Select the app in the list and select UNINSTALL .

Table 16 *Troubleshooting the TC52 (Continued)*

Problem	Cause	Solution
The device does not decode with reading bar code.	Scanning application is not loaded.	Load a scanning application on the device or enable DataWedge. See the system administrator.
	Unreadable bar code.	Ensure the symbol is not defaced.
	Distance between exit window and bar code is incorrect.	Place the device within proper scanning range.
	Device is not programmed for the bar code.	Program the device to accept the type of bar code being scanned. Refer to the EMDK or DataWedge application.
	Device is not programmed to generate a beep.	If the device does not beep on a good decode, set the application to generate a beep on good decode.
	Battery is low.	If the scanner stops emitting a laser beam upon a trigger press, check the battery level. When the battery is low, the scanner shuts off before the device low battery condition notification. Note: If the scanner is still not reading symbols, contact the distributor or the Global Customer Support Center.
Device cannot find any Bluetooth devices nearby.	Too far from other Bluetooth devices.	Move closer to the other Bluetooth device(s), within a range of 10 meters (32.8 feet).
	The Bluetooth device(s) nearby are not turned on.	Turn on the Bluetooth device(s) to find.
	The Bluetooth device(s) are not in discoverable mode.	Set the Bluetooth device(s) to discoverable mode. If needed, refer to the device's user documentation for help.
Cannot unlock device.	User enters incorrect password.	If the user enters an incorrect password five times, the user is requested to wait for 30 seconds when using a PIN, Pattern or Password.

Technical Specifications

Introduction

The following sections provide technical specification for the device.

TC52

Table 17 TC52 Technical Specifications

Item	Description
Physical Characteristics	
Dimensions	Height: 155 mm (6.1 in.) Width: 75.5 mm (2.9 in.) Depth: 18.6 mm (0.73 in.)
Weight	249 g (8.8 oz) with battery
Display	5.0 in. High Definition (1280 x 720); exceptionally bright, outdoor viewable; optically bonded to touch panel
Touch Panel	Dual mode capacitive touch with stylus or bare or gloved fingertip input (conductive stylus sold separately); Corning Gorilla Glass; water droplet rejection; fingerprint resistant anti-smudge coating.
Backlight	Light Emitting Diode (LED) backlight
Battery	Rechargeable Li-Ion, 4,150 mAh, 4.4 volts Power Precision+ with improved battery technology for longer cycle times and real-time visibility into battery metrics for better battery management. Fast USB charging up to 2.4 A.
Expansion Slot	User accessible MicroSD up to 32 GB SDHC and up to 256 GB SDXC, using FAT32 format.
Connection Interface	Universal Serial Bus (USB) 2.0 High Speed (host and client)
Network Connections	WLAN, WPAN (Bluetooth)
Notification	Audible tone, multi-color LEDs, and vibration.
Keypad	On-screen keyboard.
Voice and Audio	Three microphones with noise cancellation; vibrate alert; speaker; Bluetooth wireless headset support. High quality speaker phone; PTT headset support; Cellular circuit switch voice; HD Voice and SWB & FB audio.

Technical Specifications

Table 17 TC52 Technical Specifications (Continued)

Item	Description
Buttons	Programmable back button; dual dedicated scan buttons; dedicated push-to-talk button, and volume up/down buttons
Performance Characteristics	
CPU	Qualcomm Snapdragon 660 octa-core, 2.2 GHz.
Operating System	Android 8.1 Oreo with Zebra's Restricted Mode for control over GMS and other services.
Memory	4 GB RAM/32 GB Flash
Output Power	USB - 5 VDC @ 500 mA max
User Environment	
Operating Temperature	-20°C to 50°C (-4°F to 122°F)
Relative Humidity	Operating: 5 to 95% non-condensing
Storage Temperature	-40°C to 70°C (-40°F to 158°F)
Charging Temperature	0° C to 40° C (32°F to 104°F)
Humidity	5 to 85% non-condensing
Drop Specification	Multiple 1.2 m (4 ft.) to tile over concrete over -10°C to 50°C (14°F to 122°F). Multiple 1.8 m (6 ft.) drops to concrete with Rugged Boot per Mil Std 810 G.
Tumble	500 0.5 m (1.6 ft.) tumbles; meets and exceeds IEC tumble specifications
Sealing	IP67 and IP65 per applicable IEC sealing specifications
Electrostatic Discharge (ESD)	±15 kVDC air discharge, ±8 kVDC direct discharge, ± 8 kVDC indirect discharge
Vibration	4 g's PK Sine (5 Hz to 2 kHz); 0.04g2/Hz Random (20 Hz to 2 kHz); 60 minute duration per axis, 3 axis
Thermal Shock	-40°C to 70°C (-40°F to 158°F) rapid transition
Interactive Sensor Technology (IST)	
Motion Sensor	3-axis accelerometer with MEMS Gyro
Light Sensor	Automatically adjusts display backlight brightness
Proximity Sensor	Automatically detects when the user places the handset against head during a phone call to disable display output and touch input.
Pressure Sensor	Automatically detects altitude information for locationing.
Magnetometer	eCompass automatically detects direction and orientation.
Wireless LAN Data and Voice Communications	
Radio	IEEE 802.11a/b/g/n/ac/d/h/i/k/r/v/w; Wi-Fi™ certified; IPv4, IPv6; 2X2 MU-MIMO
Data Rates Supported	5GHz: 802.11a/n/ac - up to 866.7 Mbps 2.4GHz: 802.11b/g/n - up to 300 Mbps

Table 17 TC52 Technical Specifications (Continued)

Item	Description
Operating Channels	Chan 1 - 13 (2412 - 2472 MHz) Chan 36 - 165 (5180 - 5825 MHz) Channel Bandwidth: 20, 40, 80 MHz Actual operating channels/frequencies depend on regulatory rules and certification agency
Security and Encryption	WEP (40 or 104 bit); WPA/WPA2 Personal (TKIP, and AES); WPA/WPA2 Enterprise (TKIP and AES) — EAP-TTLS (PAP, MSCHAP, MSCHAPv2), EAP-TLS, EAP-PEAPv0-MSCHAPv2, EAP-PEAPv1-GTC, EAP-LEAP, EAP-PWD. Data in Motion: FIPS 140-2 Level 1 Data at Rest: FIPS 140-2 Level 1
Certifications	WFA (802.11n, WMM-PS, 802.11r; PMF)
Fast Roam	PMKID caching; Cisco CCKM; 802.11r; OKC
Wireless PAN Data and Voice Communications	
Bluetooth	Class 2, Bluetooth v5.0, Bluetooth Low Energy (BLE)
Data Capture Specifications	
Scanning	SE4710 imager (1D and 2D) with LED aimer. Digimarc support.
Camera	Front — 5 MP; f/2.0 aperture front facing camera. Rear — 13 MP autofocus; f/2.2 aperture; rear camera flash LED generates balanced white light; supports Torch mode; 4K video with image stabilization.
Near Field Communications (NFC)	ISO 14443 Type A and B; F; FeliCa and ISO 15693 cards; P2P mode and Card Emulation via Host
2D Imager Engine (SE4710) Specifications	
Field of View	Horizontal - 48.0° Vertical - 36.7°
Image Resolution	1280 horizontal X 960 vertical pixels
Roll	360°
Pitch Angle	± 60° from normal
Skew Tolerance	± 60° from normal
Ambient Light	Sunlight: 10,000 ft. candles (107,639 lux)
Focal Distance	From front of engine: 17.7 cm (7.0 in.)
Laser Aiming Element	Visible Laser Diode (VLD): 655 nm ± 10 nm Central Dot Optical Power: 0.6 mW (typical) Pattern Angle: 48.0° horizontal, 38.0° vertical
Illumination System	LEDs: Warm white LED Pattern Angle: 80° at 505 intensity

Table 18 Data Capture Supported Symbologies

Item	Description
1D Bar Codes	Chinese 2 of 5, Codabar, Code 11, Code 128, Code 39, Code 93, Discrete 2 of 5, EAN-13, EAN-8, Interleaved 2 of 5, MSI, UPCA, UPCE, UPCE1, ISBN/Bookland, ISSN, Coupon Code, Matrix 2 of 5
2D Bar Codes	Australian Post, Aztec Code, Canada Postal, Composite AB, Composite C, DataMatrix, Dutch Postal, GS1 DataBar, GS1 Expanded, GS1 Limited, GS1 Datamatrix, Han Xin, Japan Postal, Maxicode, Micro PDF, Micro QR Code, PDF-417, QR Code, TLC-39, PDF-417, UK Postal, US4state, US4State FICS, US Planet, US Postnet

Index

Numerics

1-slot USB/charge only cradle kit	142
4-slot battery charger kit	143
4-slot charge only cradle with battery charger kit	142
5-slot charge only cradle kit	142
5-slot Ethernet cradle kit	142

A

ActiveEdge touch zone	60
configuring	60
selecting apps for a drawer	61
using	64
adaptive frequency hopping	135
alarms only	46
albums	84, 91
deleting	85, 91
getting information	84
sharing	84, 91
working with	84, 91
ambient display setting	31
approved cleanser	181
approved cleanser active ingredients	181
apps	48
accessing	51
ActiveEdge touch zone	60
adding shortcuts	42
Battery Manager	66
camera	70
DataWedge Demonstration	98
Device Central	95
Diagnostic Tool	76
Files	81
Gallery	82
PTT Express	100
RxLogger	103
RxLogger Utility	104
shortcuts	42
SimulScan Demo	105
Sound Recorder	113
audio adapter	143

automatically block sounds and vibrations	46
---	----

B

barcode scanning	
digital camera	114
basic hand strap	144
battery	18, 142
low battery notification	27
monitor usage	26
battery charging	21
battery management	26
battery level	26
battery present status	26
Battery Manager	66
battery optimization	27
battery swap	23
Bluetooth	133, 135
change name	138
disabling	138
discovering devices	138
enabling	137
PIN	136
power states	137
profiles	136
security	136
bluetooth	135

C

camera	18, 48, 70
front camera photo settings	72
front camera video settings	74
photo settings	72
rear camera photo settings	73
rear camera video settings	74
recording videos	71
taking panoramic photos	71
taking photos	70
video settings	74
camera settings	72, 74
cast	141

change Bluetooth name	138
cleaning	180, 181
frequency	182
instructions	180
cleaning instructions	181
Configurations	12
connect to WLAN	134
contacts	69
adding	69
deleting	69
editing	69
cradle	
connector cleaning	183
cradle mount	142
D	
data capture	114
digital camera	114
DataWedge	132
datawedge	
disable	132
enable	132
DataWedge Demonstration	98
DC line cord	145
Device Central	95
device central	
paging an RS6000 ring scanner	96
tabs	95
device settings	
accessing	25
Diagnostic Tool	76
diagnostic tool	
battery test information	79
bluetooth test information	80
gps test information	80
settings	79
system test information	80
wlan test information	80
wwan test information	80
digital camera	114
barcode scanning	114
data capture	114
disable Bluetooth	138
disconnect host computer	58
discover Bluetooth devices	138
display	
cleaning	182
Display settings	28
do not disturb feature	45
DS3678	
pairing	130
pairing using Bluetooth HID	131
pairing using simple serial interface	130
scanning	124

E	
EAP	133
enable Bluetooth	137
Ethernet connection	157
F	
feature	17
feedback	15
file transfer	58
Files	81
finger usage	31
folders	43
creating	43
naming	43
removing	44
font size	30
G	
Gallery	82
gallery	
cropping photos	86
deleting albums	85
deleting photos	87
deleting videos	88
getting album information	84
setting photos as contact icons	86
sharing albums	84
sharing photos	87
sharing videos	87
viewing photos	85
watching videos	87
working with albums	84
working with photos	85
working with videos	87
general sound setting	32
Google	
account setup	22
mobile services	35
H	
hand strap	143
hands-free imager	116
hard reset	57
harmful ingredients	181
headset jack	19
home screen	35
moving items	43
home screen rotation	29
home screen wallpaper	44

- I**
- imager scanning 114
 - install microsd card 19
- K**
- keyboards
 - configuration 45
 - editing text 45
 - entering numbers, symbols, and special characters 45
- L**
- light sensor 17
 - linear imager 115
 - lock screen notifications 40
 - low battery notification 27
- M**
- maintenance
 - approved cleanser active ingredients 181
 - cleaning frequency 182
 - cleaning instructions 180
 - device cleaning instructions 181
 - harmful ingredients 181
 - special cleaning notes 181
 - managing notifications 38
 - microSD card 19, 24
 - monitor battery usage 26
- N**
- near field communication 133
 - near field communications 139
 - NFC 139
 - reading cards 140
 - sharing information 140
 - NFC antenna 18
 - notational conventions 13
 - notification icons 38
 - notifications
 - lock screen 40
 - managing 38
- P**
- pairing
 - DS3678 130
 - RS507/RS6000 hands-free imager 126
 - using Bluetooth HID (RS507/RS6000) 129
 - using Bluetooth HID(DS3678) 131
 - using simple serial interface (DS3678) 130
 - using simple serial interface(RS507/RS6000) 128
 - panoramic 71
 - photo transfer 58
 - photos 89
 - camera settings 72
 - cropping 86, 93
 - deleting 87, 94
 - deleting albums 91
 - deleting videos 94
 - panoramic 71
 - setting as contact icons 86, 93
 - sharing 87, 94
 - sharing albums 91
 - sharing videos 94
 - taking 70
 - viewing 85, 92
 - watching videos 94
 - working with 85, 92
 - working with albums 91
 - working with videos 94
 - picklist 115
 - power supply 144
 - proximity sensor 17
 - PTT button 18
 - PTT Express
 - audible indicators 100
 - disabling communication 102
 - enabling communication 101
 - group calls 102
 - notification icons 100
 - private response 102
 - talk groups 101
 - Voice Client 100
 - PTT-Express
 - PTT communication 101
- Q**
- quick access panel 40
 - quick settings
 - edit icons 41
- R**
- reading NFC cards 140
 - remove wi-fi 135
 - resetting the device 56
 - resetting 56
 - RS507
 - scanning 122
 - RS507 scanning 122, 124, 125
 - RS507/RS6000
 - pairing 126
 - pairing using Bluetooth HID 129
 - pairing using simple serial interface 128

RS6000	
scanning	121
RS6000 scanning	121
rugged boot	143
rugged charge/USB cable	143
RxLogger	103
RxLogger Utility	104

S

scan button	18
scanning	114, 118, 120
considerations	118
DS3678	124
RS507	122
RS6000	121
screen font size	30
screen rotation	28
security	133
setting	
camera	72, 74
notification LED	32
wakeup sources	33
settings	
accessing	25
ambient display	31
automatically block sounds and vibrations	46
camera photos	72
camera videos	74
display	28
do not disturb	45
general sound	32
home screen wallpaper	44
limit sounds and vibrations	46
override do not disturb for specific apps	48
sharing information using NFC	140
SimulScan	
settings	109
SimulScan Demo	105
advanced settings	110
creating a demo customization	111
default templates	112
printing sample forms	105
using the manufacturing example	108
using the postal, transportation and logistics example	106
soft holster	143
soft reset	56
software version	13
software versions	12
Sound Recorder	113
speaker	17
status bar	37
stylus	144
symbolologies	190

T

taking a panoramic photo	71
touch mode	31
transferring files using USB	57
trigger handle	143
trigger handle kit	143
troubleshooting	184

U

USB	57
-----	----

V

videos	
camera settings	74
deleting	88, 94
recording	71
sharing	87, 94
watching	87, 94
working with	87, 94

W

wakeup sources	33
WEP	133
widgets	42
adding	42
wi-fi network	134
wireless local area network	133
WLAN	133
WPA	133

