CipherLab Reference Manual

RS38 Mobile Computer
Powered by Android™ 13

Version 1.2



Copyright © 2025 CIPHERLAB CO., LTD.

All rights reserved

The software contains proprietary information of its owner; it is provided under a license agreement containing restrictions on use and disclosure and is also protected by copyright law. Reverse engineering of the software is prohibited.

Due to continued product development, this information may change without notice. The information and intellectual property contained herein is confidential between the owner and the client and remains the exclusive property of the owner. If having any problems in the documentation, please report them to us in writing. The owner does not warrant that this document is error-free.

No part of this publication may be reproduced, stored in a retrieval system, or transmitted in any form or by any means, electronic, mechanical, photocopying, recording or otherwise without the prior written permission of the owner.

For product consultancy and technical support, please contact the local sales representative. Also, visit our website for more information.

All brand, logo, product and service, and trademark names are the property of their registered owners.

Google, Android, Google Play and other marks are trademarks of Google LLC.

The editorial use of these names is for identification as well as to the benefit of the owners, with no intention of infringement.

CIPHERLAB logo is a registered trademark of CIPHERLAB CO., LTD. All other brands, products and services, and trademark names are the property of their registered owners. The editorial use of these names is for identification as well as to the benefit of the owners, with no intention of infringement.

CIPHERLAB CO., LTD.

Website: <http://www.CipherLab.com>

IMPORTANT NOTICES

FOR USA

This equipment has been tested and found to comply with the limits for a **Class B** digital device, pursuant to Part 15 of the FCC Rules. These limits are designed to provide reasonable protection against harmful interference in a residential installation. This equipment generates, uses and can radiate radio frequency energy and, if not installed and used in accordance with the instructions, may cause harmful interference to radio communication. However, there is no guarantee that interference will not occur in a particular installation. If this equipment does cause harmful interference to radio or television reception, which can be determined by turning the equipment off and on, the user is encouraged to try to correct the interference by one or more of the following measures:

- ▶ Reorient or relocate the receiving antenna.
- ▶ Increase the separation between the equipment and receiver.
- ▶ Connect the equipment into an outlet on a circuit different from that to which the receiver is connected.
- ▶ Consult the dealer or an experienced radio/TV technician for help.

This device complies with Part 15 of the FCC Rules. Operation is subject to the following two conditions: (1) This device may not cause harmful interference, and (2) this device must accept any interference received, including interference that may cause undesired operation.

FCC Caution:

Any changes or modifications not expressly approved by the party responsible for compliance could void the user's authority to operate this equipment.

This transmitter must not be co-located or operating in conjunction with any other antenna or transmitter.

Find the certificate information from:

Settings → Legal information → Electronic authentication



Tested to Comply with FCC Standards

FOR HOME OR OFFICE USE

FOR PRODUCT WITH LASER

- ▶ This laser component emits FDA / IEC Class 2 laser light at the exit port. Do NOT STARE INTO BEAM DIRECTLY.
- ▶ Do not aim the beam at the eyes.
- ▶ Any adjustments or performance excluding those specified herein may result in hazardous laser light exposure.



ENVIRONMENT

- ▶ Operate the mobile computer at ambient temperatures from -20°C to 50°C and with humidity range from 10% to 90%.
- ▶ Store the device at ambient temperatures from -30°C to 70°C and with humidity range from 5% to 95%.
- ▶ This device is built with a dust-proof and splash-proof structure that conforms to protection class IP65/ IP68.

SPECIFIC ABSORPTION RATE (SAR) INFORMATION

- ▶ USA

This device meets the government's requirements for exposure to radio waves. This device is designed and manufactured not to exceed the emission limits for exposure to radio frequency (RF) energy set by the Federal Communications Commission of the U.S. Government.

The exposure standard employs a unit of measurement known as the Specific Absorption Rate, or SAR. The SAR limit set by the FCC is 1.6 W/kg. Tests for SAR are conducted using standard operating positions accepted by the FCC with the EUT transmitting at the specified power level in different channels.

The FCC has granted an Equipment Authorization for this device with all reported SAR levels evaluated as in compliance with the FCC RF exposure guidelines. SAR information on this device is on file with the FCC and can be found under the Display Grant section of www.fcc.gov/eot/ea/fccid after searching on FCC ID: Q3N-RS38

▶ Canada

The radiated output power of the Wireless Device is below the Innovation, Science and Economic Development Canada (ISED) radio frequency exposure limits. The Wireless Device should be used in such a manner such that the potential for human contact during normal operation is minimized.

This device has been evaluated for and shown compliant with the ISED Specific Absorption Rate ("SAR") limits when operated in portable exposure conditions.

This device contains licence-exempt transmitter(s)/receiver(s) that comply with Innovation, Science and Economic Development Canada's licence-exempt RSS(s). Operation is subject to the following two conditions:

- (1) This device may not cause interference.
- (2) This device must accept any interference, including interference that may cause undesired operation of the device.

La puissance de sortie rayonnée du dispositif sans fil est inférieure aux limites d'exposition aux radiofréquences d'Innovation, Sciences et Développement économique Canada (ISED). Le dispositif sans fil doit être utilisé de manière à minimiser le potentiel de contact humain pendant le fonctionnement normal.

Cet appareil a été évalué et montré conforme aux limites de DAS (Débit d'Absorption Spécifique) de l'ISED lorsqu'il est utilisé dans des conditions d'exposition portables.

L'émetteur/récepteur exempt de licence contenu dans le présent appareil est conforme aux CNR d'Innovation, Sciences et Développement économique Canada applicables aux appareils radio exempts de licence. L'exploitation est autorisée aux deux conditions suivantes :

- (1) L'appareil ne doit pas produire de brouillage;
- (2) L'appareil doit accepter tout brouillage radioélectrique subi, même si le brouillage est susceptible d'en compromettre le fonctionnement.

▶ Europe

A minimum separation distance of 0.5 cm must be maintained between the user's body and the device, including the antenna during body-worn operation to comply with the RF exposure requirements in Europe.

To compliance with RF Exposure requirements in Europe, third-party belt-clips, holsters or similar accessories used by this device should not contain any metallic components. The use of accessories that do not satisfy these requirements may not comply with RF exposure requirements, and should be avoided.

CE SAR Value (Standard limit is 2 W/Kg)

EU (10g): Max. 1.35 W/Kg

▶ DoC

Hereby, CIPHERLAB CO, declares that this RS38 is in compliance with the essential requirements and other relevant provisions of Directive 2014/53/EU.

URL: www.cipherlab.com

Indoor restriction: In EU, 5150 to 5350MHz is restricted indoor.

▶ Power Adapter Information

INPUT: 100-240V~50/60Hz 0.35A

OUTPUT/: 5.0V 2.0A 10.0W

IMPORTANT SAFETY INSTRUCTIONS AND WARNINGS FOR LI-ION/POLYMER BATTERY

Lithium batteries are prone to capacity loss and swelling when exposed to high temperatures, excessive discharge, or overcharging. While CipherLab pre-charges batteries before shipment to prevent excessive discharge, it's crucial for customers to follow the guidelines below for battery usage and storage:

- 1. If the batteries will not be used for long periods, store them in an environment at room temperature and charge them to 60% to 70% of capacity every 3 to 4 months.**
 - 2. Please avoid leaving the battery installed in the device for long periods, even when the device is powered off. Standby power consumption may occur, leading to potential excessive discharge of the battery.**
 - 3. Avoid prolonged charging of the batteries. It is recommended to unplug the charging cable within 48 hours after the battery is fully charged to avoid damaging the battery's lifespan.**
- ▶ Lithium Polymer and Li-ion batteries are volatile. Failure to read and follow the instructions may result in personal injury and damage to device if charged or used improperly.
 - ▶ Lithium Polymer/Li-ion batteries have limited life cycle for charging and discharging. When life cycle has been reached, battery may swell.
 - ▶ Keep Lithium Polymer and Li-ion battery away from children.
 - ▶ Never make wrong polarity connection when charging and discharging battery. Always double check polarity of battery's connector.
 - ▶ If the battery has not been used or has been left in the device for 2 months, please fully discharge and recharge it once before use. Always remove the battery from the device if you will not use the device for a long period of time.

CAUTION

RISK OF EXPLOSION IF BATTERY IS REPLACED BY AN INCORRECT TYPE.

DISPOSE OF USED BATTERIES ACCORDING TO THE INSTRUCTIONS

- ▶ Disposal of a battery into fire or a hot oven, or mechanically crushing or cutting of a battery, that can result in an explosion;
- ▶ Leaving a battery in an extremely high temperature surrounding environment that can result in an explosion or the leakage of flammable liquid or gas.
- ▶ A battery subjected to extremely low air pressure that may result in an explosion or the leakage of flammable liquid or gas.

GENERAL GUIDELINE AND WARNING

- ▶ Use specific Lithium Polymer/Li-ion charger from CipherLab only. Failure to do so may cause fire, which may result in personal injury and property damage.
- ▶ Never charge batteries unattended. When charging Lithium Polymer/Li-ion batteries, always remain vigilant and observe the charging process continuously to monitor for potential problems and react promptly if any issues arise.
- ▶ Some Polymer/Li-ion chargers on the market may have technical deficiencies that could lead to incorrect charging or charging at an improper rate for LiPo/Li-ion batteries. Ensure that the charger you have purchased is functioning properly and always monitor the charging process to ensure that the batteries are being charged correctly. Failure to do so may result in a fire.
- ▶ If at any time you notice a battery starting to balloon, swell up, smoke, or become hot, cease using the battery immediately and contact your dealer without delay.
- ▶ If you accidentally short the battery polarity, place the battery in a safe area for observation for approximately 15 minutes. Additionally, if a short occurs and contact is made with metal (such as rings on your hand), severe injuries may occur due to the conductivity of electric current.
- ▶ In the event of a crash due to poor shipment or other reasons, you must remove the damaged battery for observation and replace the damaged batteries with new ones from other undamaged batteries.
- ▶ Never drop the batteries.
- ▶ Do NOT expose the battery to water.
- ▶ Do NOT attempt to disassemble battery.
- ▶ It is recommended to place the battery in an enclosure to protect it from damage by liquid or dropping from height accidentally.

CHARGING PROCESS

- ▶ Please ensure to charge the battery indoors, such as in a well-ventilated room, between 20°C to 30 °C.
- ▶ Do NOT charge battery under direct sunlight.
- ▶ When selecting the cell count or voltage for charging purposes, choose the cell count and voltage as indicated on the battery label. As a safety precaution, please verify that the information printed on the battery is correct.
- ▶ Lithium Polymer/Li-ion batteries have limited life cycle for charging and discharging. When life cycle has been reached, battery may swell.
- ▶ The permitted charging ambient temperature range is 0°C to 40°C, and the permitted battery cell temperature range is 0°C to 50°C.
- ▶ During discharge and handling of batteries, do not exceed 50°C.

STORAGE & TRANSPORTATION

- ▶ Due to aviation regulations, CipherLab batteries are charged to approximately 30% of their full capacity during manufacturing.
- ▶ Battery should NOT be stored in fully charged or deeply discharged state, as it may damage the battery.
- ▶ The battery may undergo discharge even when not installed in a device. For any stored and unused battery, it is highly recommended to charge the battery to 60% to 70% of its original capacity every 3 to 4 months to prolonged storage.
- ▶ Always detach the battery from the device if you will not be using the device for an extended period of time.
- ▶ Store the battery indoors at a temperature between 25°C to 30°C for optimal performance.
- ▶ Do NOT store battery in temperature exceeding 50°C, and avoid exposing the battery pack to high external pressure for extended periods. This can lead to internal short circuit and overheating.
- ▶ When transporting or temporarily storing in a vehicle, ensure the temperature range is above 0°C but does not exceed 45°C.
- ▶ Storing the battery at temperatures exceeding 50°C for extended periods (more than 2 hours) may cause damage to the battery.

TO USE, HANDLE, AND DISPOSE BATTERY

- ▶ For Li-ion / Li-polymer batteries, it is normal for them to balloon, expand, or swell after one year or 500 cycles (full charge-discharge cycles). Although we guarantee that this will not cause any damage, the battery cannot be used again and must be disposed of immediately. Therefore, we strongly recommend replacing the battery either every year or after 500 cycles, depending on which comes first.
- ▶ If a battery performance decreases more than 20%, it indicates that the battery has reached the end of its life cycle. Please stop using this battery, dispose of it properly according to the location's safe battery disposal procedures, and replace it with a new or healthy one.
- ▶ The actual number of charge cycles will vary depending on usage conditions, patterns, ambient temperature, and other variables.
- ▶ Deep discharge below 3V can degrade battery performance.
- ▶ Use caution to avoid puncturing the battery, as puncturing may damage the battery cell.
- ▶ Periodically and properly dispose of used batteries according to local regulations.

PRODUCT WARRANTY

Product warranty is limited to original manufacturing defects in material only. Warranty will not apply to batteries with reduced capacity due to user scenario, unless determined to be a manufacturing flaw.

Warranty does not cover collateral damage. Misuse, abuse, incorrect charging and other inappropriate use of this product are not covered under warranty.

SAFETY PRECAUTIONS



Warning statement:

A pleine puissance, l'écoute prolongée du baladeur peut endommager l'oreille de l'utilisateur.

To prevent possible hearing damage, do not listen at high volume levels for long periods.

RISK OF EXPLOSION IF BATTERY IS REPLACED BY AN INCORRECT TYPE. DISPOSE OF USED BATTERIES ACCORDING TO THE INSTRUCTIONS.

For people's safety

- ▶ Do not listen at high volume levels for long periods to prevent possible hearing damage.
- ▶ Do not operate this device while walking, cycling or car driving.

For the equipment

- ▶ Do not use any batteries or charging devices which are not originally sold or manufactured by CIPHERLAB CO., LTD.
- ▶ Do not replace the battery with an incorrect type, to avoid the risk of heat generation, fire, or explosion.
- ▶ Do not disassemble, incinerate or short circuit the battery.
- ▶ Do not touch the contact pins of the battery pack.
- ▶ Do not expose the mobile computer or battery to any flammable sources.
- ▶ Do not expose the mobile computer to extreme temperatures or soak it in water.
- ▶ Do not use any pointed or sharp objects against the screen surface.
- ▶ Do not use the styluses which are not supplied or approved by CIPHERLAB CO., LTD., to prevent possible scratches to the touch screen.
- ▶ Water residue on the touch screen may cause abnormal behaviors or the fall of its sensitivity levels.
- ▶ On the surface of the terminal and the barcode reading window, the fog or water drops caused by low temperatures may influence barcode reading.
- ▶ Do not use bleaches or cleaners to clean the device. Use a clean, wet cloth instead.

SCANNER

▶ Scan a 1D barcode

- 1) Open **ReaderConfig** and tap **Scan Test** on the menu bar.
- 2) Aim the scanning window at the barcode to read. Move the device, having the barcode located in the center of the scanning area.
- 3) Press any of the two side triggers. The scanning light beams to read the printed barcodes. The buzzer beeps after scanning. The scanning light goes off once the data is decoded, or when the decode timeout period has passed.

▶ Scan a 2D barcode

- 1) Open **ReaderConfig** and tap **Scan Test** on the menu bar.
- 2) Aim the scanning window at the barcode to read. Move the device, having the barcode located in the center of the scanning area.
- 3) Press any of the two side triggers. The scanning light beams to read the printed barcodes. The buzzer beeps after scanning. The scanning light goes off once the data is decoded, or when the decode timeout period has passed.

CONNECTION

- ▶ Via Bluetooth or WLAN
- ▶ Connection may fail when the mobile computer is around other wireless machines or power cables as the radio frequencies of those may cause interferences.
- ▶ If communication fails, move the devices much closer to each other, and try to communicate again
- ▶ After turning on, Bluetooth power is sustained even when the mobile computer is suspended. However, if the power mode is switched to Airplane Mode, Bluetooth power will be turned off regardless of the settings.

To a Charging & Communication Cradle

- ▶ Do not insert the mobile computer to a Charging & Communication Cradle if water or drippings are staying on the device.
- ▶ The LED indicator on a Charging & Communication Cradle shows the status of battery charging only; the status of terminal charging is shown on the device itself.
- ▶ Not Charging could be the result of battery damage, battery's failure to touch the connector or AC plug coming off.
- ▶ Charging error could be due to high battery temperature.

CARE & MAINTENANCE

- ▶ This mobile computer is intended for industrial use. The mobile computer is rated IP65 /IP68, however, damage may be done to the mobile computer if it is exposed to extreme temperatures or soaked in water.
- ▶ When the body of the mobile computer gets dirty, use a clean, wet cloth to wipe off dust and debris. DO NOT use bleaches or cleaners.
- ▶ Use a clean, non-abrasive, lint-free cloth to wipe dust off the LCD touch screen. DO NOT use any pointed or sharp objects against the surface. Always keep the LCD dry.
- ▶ If you plan to store the mobile computer for an extended period, follow these steps: download collected data to a host computer, power off the system by long-pressing the power button and tapping "Power off" on the screen, then remove the battery pack from the compartment. Store the mobile computer and battery pack separately.
- ▶ If you encounter malfunction on the mobile computer, write down the specific scenario and consult your local sales representative.
- ▶ In order to prevent system from shutting down after the battery is drained out, keep a fully charged battery for replacement at all times, or connect the mobile computer to an external power.
- ▶ If there are drippings or dust on the device or battery pack, wipe them away with a soft clean cloth before battery replacement.

RELEASE NOTES

| Version | Date | Notes |
|---------|------------------------------|---|
| 1.2 | Apr, 21 st . 2025 | • Updated the screenshot for 3.6. Reset to Factory Default. |
| 1.1 | Aug, 22 nd . 2024 | • Added Section 6.15. DisplayLink. |
| 1.0 | Apr, 15 th . 2024 | • Initial release. |

CONTENTS

| | |
|--|-----------|
| IMPORTANT NOTICES | 3 |
| For USA..... | 3 |
| For Product with Laser | 4 |
| Environment | 4 |
| Specific Absorption Rate (SAR) information | 4 |
| Important Safety Instructions and Warnings for Li-ion/Polymer Battery..... | 7 |
| General Guideline and Warning..... | 8 |
| Charging Process | 9 |
| Storage & Transportation..... | 10 |
| To Use, Handle, and Dispose Battery | 10 |
| Product Warranty..... | 11 |
| Safety Precautions | 12 |
| Scanner..... | 13 |
| Connection | 13 |
| Care & Maintenance | 14 |
| RELEASE NOTES | 15 |
| CONTENTS | 16 |
| INTRODUCTION..... | 20 |
| Features..... | 21 |
| Inside the Package..... | 22 |
| Accessories..... | 22 |
| Related Documentation | 22 |
| CHAPTER 1. QUICK START | 23 |
| 1.1. Overview..... | 24 |
| 1.1.1. Install/Remove Battery | 25 |
| 1.1.2. Install/Remove SIM Card and Memory Card..... | 28 |
| 1.1.3. Power On/Off Mobile Computer..... | 30 |
| 1.2. Charging & Communication..... | 31 |
| 1.2.1. Charge the Mobile Computer..... | 31 |
| 1.2.2. Wired Data Transmission | 38 |
| 1.2.3. Using Wireless Networks..... | 39 |
| CHAPTER 2. USING THE RS38 MOBILE COMPUTER | 40 |
| 2.1. Battery..... | 41 |
| 2.1.1. Battery Status Indicators | 42 |
| 2.1.2. Monitor Battery Level | 44 |
| 2.1.3. Replace Main Battery..... | 50 |
| 2.1.4. Power Management..... | 53 |
| 2.1.5. Battery Precautions | 55 |

| | | |
|--|---|-----------|
| 2.2. | Memory | 57 |
| 2.2.1. | Check Memory Usage..... | 58 |
| 2.2.2. | Manage Storage Space | 61 |
| 2.3. | Touch Screen | 71 |
| 2.3.1. | Screen Brightness..... | 71 |
| 2.3.2. | Screen Rotation | 72 |
| 2.3.3. | Screen Timeout Settings | 78 |
| 2.3.4. | Display Size and Text..... | 79 |
| 2.4. | Notifications..... | 80 |
| 2.4.1. | Status LED | 80 |
| 2.4.2. | Audio..... | 80 |
| 2.4.3. | Sound and Vibration..... | 81 |
| 2.5. | Date and Time | 87 |
| 2.6. | Language & Keyboard Input | 91 |
| 2.6.1. | Change Display Language | 91 |
| 2.6.2. | On-screen Keyboard | 94 |
| 2.7. | Sound and Volume | 96 |
| 2.8. | Data Capture..... | 96 |
| 2.7.1. | Barcode Reader | 96 |
| 2.7.2. | Digital Camera | 96 |
| CHAPTER 3. BASIC OPERATION..... | | 97 |
| 3.1. | Home Screen | 98 |
| 3.1.1. | Application & Widget on Home Screen..... | 99 |
| 3.1.2. | Folder on Home Screen..... | 100 |
| 3.2. | Navigation Method..... | 101 |
| 3.2.1. | Change the Navigation Method | 101 |
| 3.2.2. | Recently Used Applications | 104 |
| 3.3. | Status Bar | 105 |
| 3.3.1. | Icons on Status Bar | 105 |
| 3.3.2. | Open Quick Setting Menu | 107 |
| 3.3.3. | Open Notifications Drawer | 112 |
| 3.4. | Suspend & Lock | 115 |
| 3.4.1. | Suspend Device | 115 |
| 3.4.2. | Lock Device | 116 |
| 3.4.3. | OS Update | 118 |
| 3.4.4. | Network Update | 118 |
| 3.4.5. | SD Card Update..... | 120 |
| 3.5. | Back up Your Data..... | 121 |
| 3.6. | Reset to Factory Default..... | 123 |
| 3.6.1. | Erase All Data (Factory Reset)..... | 123 |
| 3.6.2. | Erase All Date (Factory Reset with Enterprise)..... | 125 |
| 3.6.3. | Welcome Wizard | 126 |

| | |
|--|------------|
| CHAPTER 4. WIRELESS RADIOS | 131 |
| 4.1. Use Wireless Local Area Network (Wi-Fi)..... | 132 |
| 4.1.1. Connect to Wi-Fi Network | 132 |
| 4.1.2. Manually Add Wi-Fi Network | 134 |
| 4.1.3. Wi-Fi Preference | 137 |
| 4.1.4. Modify Wi-Fi Network | 141 |
| 4.1.5. Disconnect Wi-Fi Network | 143 |
| 4.2. Use Bluetooth | 144 |
| 4.2.1. Bluetooth Profiles..... | 144 |
| 4.2.2. Turn On Bluetooth | 146 |
| 4.2.3. Change Bluetooth Name..... | 149 |
| 4.2.4. Pair Bluetooth Devices..... | 150 |
| 4.2.5. Unpair Bluetooth Device | 152 |
| 4.3. Use Near Field Communications..... | 153 |
| 4.3.1. Pair with NFC Enabled Bluetooth Devices | 154 |
| 4.3.2. Communication with NFC | 154 |
| CHAPTER 5. USING THE PHONE | 155 |
| 5.1. SIM Card Management | 156 |
| 5.2. Phone Application..... | 160 |
| 5.2.1. Phone Interface | 161 |
| 5.2.2. Place Call | 163 |
| 5.2.3. During A Call..... | 164 |
| 5.2.4. Receive Incoming Call..... | 165 |
| 5.2.5. Check Missed Calls..... | 166 |
| 5.2.6. Call History..... | 167 |
| 5.2.7. Call Settings | 168 |
| 5.2.8. Make Multi-Party Calls | 169 |
| 5.3. Audio Modes | 170 |
| 5.4. In-call Volume..... | 171 |
| CHAPTER 6. CIPHERLAB UTILITIES | 172 |
| 6.1. A-Demo | 173 |
| 6.2. AppLock..... | 175 |
| 6.3. Barcode To Setting..... | 176 |
| 6.4. BT Printer Mate..... | 181 |
| 6.5. Button Assignment | 181 |
| 6.6. Enterprise Settings | 182 |
| 6.7. HF RFID Configuration..... | 183 |
| 6.8. ReaderConfig | 184 |
| 6.9. Signature Capture | 185 |
| 6.10. SIP Controller | 186 |
| 6.11. Software Trigger | 190 |

| | | |
|-----------------------------|-------------------------------------|------------|
| 6.12. | LogGen | 194 |
| 6.13. | Wireless Init..... | 195 |
| 6.14. | Ping | 196 |
| 6.15. | DisplayLink | 199 |
| SPECIFICATIONS | | 200 |
| | Physical Characteristics | 200 |
| | Platform, Processor & Memory..... | 201 |
| | Communication & Data Capture | 201 |
| | Electrical Characteristics..... | 203 |
| | Environmental Characteristics | 204 |
| | Programming Support | 205 |
| APPENDIX I..... | | 206 |
| | Application Menu | 206 |
| APPENDIX II | | 209 |
| | Open Source License | 209 |

INTRODUCTION

The **RS38** mobile computer, running on Android 13, offers a lightweight design and user-friendly interface. It provides a range of powerful tools aimed at enhancing flexibility through customization.

Specifically designed to work as an industrial PDA, it provides rich options of data collection, voice and data communication, long-lasting working hours, and so on. Its large color transmissive display guarantees ease in reading in all lighting conditions. Integrated with Bluetooth® Class II, v5.2 dual mode, v2.1 with EDR (Enhanced Data Rate), IEEE 802.11 a/b/g/n/ac/ax/d/h/i/r/k/v/w/mc (802.11ax only on WIFI 6 model) networking technologies, the mobile computer also includes a GSM/UMTS/WCDMA/HSPA/HSPA+/LTE/VOLTE module to gain greater speeds and optimal mobility. In particular, an integrated GPRS/EGPRS receiver is made available for use with third-party location-based applications.

This manual serves to guide you through how to install, configure, and operate the mobile computer. The [Care & Maintenance](#) section is specifically crucial for those who are in charge of taking care of the mobile computer.

We recommend you to keep one copy of the manual at hand for quick reference or maintenance purposes. To avoid any improper disposal or operation, please read the manual thoroughly before use.

FEATURES

- ▶ Built tough to survive drop test and sealed against moisture/dust to industrial standard IP65/ IP68.
- ▶ Android 13 operating system with a powerful Qualcomm QCM4490.
- ▶ 128GB Flash memory to store OS and software programs.
- ▶ 8GB LPDDR5 RAM to store and run programs, as well as store program data.
- ▶ One expansion slot for microSDHC card up to 32GB and microSDXC card up to 1TB.
- ▶ Built-in autofocus 16 megapixels rear camera with LED flash.
- ▶ Left and right side triggers for ambidextrous scanning
- ▶ Total wireless solution — connectivity includes Bluetooth® Class II, v5.2 dual mode, v2.1 with EDR (Enhanced Data Rate), IEEE 802.11 a/b/g/n/ac/ax/d/h/i/r/k/v/w/mc (802.11ax only on WIFI 6 model), GPRS/EGPRS/GSM/UMTS/WCDMA/HSPA/HSPA+/LTE/VOLTE, and near field communication (NFC).
- ▶ A 6-inch, transmissive IPS LCD, Corning® Gorilla® Glass display with 1080x2160 pixels to deliver excellent visibility in all lighting conditions.
- ▶ Configurable feedback indicators included.
- ▶ Vibrator and Dual speakers.
- ▶ Built-in scan engine setting tool Reader Configuration which serves out-of-the-box keyboard wedge functionality.

INSIDE THE PACKAGE

The following items are included in the kit package. Save the box and packaging material for future use in case you need to store or ship the mobile computer.

RS38 Mobile Computer

Battery

Hand Strap

Quick Start Guide

Type-C USB Cable (optional)

AC Power Adapter (optional)

ACCESSORIES

Workstation Connect Cradle

Mobile Computer Pistol

Rubber Boot

UHF RFID Reader

4-Slot Battery Charger

5-Slot Charging Cradle

4-Slot Charging Cradle & 4-Slot Battery Cradle

RELATED DOCUMENTATION

Please visit [CipherLab website](#) to access the related documentation about the RS38 mobile computer.

Chapter 1

CHAPTER 1. QUICK START

This chapter helps you get started with your mobile computer by providing an overview of its exterior, detailing battery installation/removal, and introducing the charging and communication features.

IN THIS CHAPTER

| | |
|-------------------------------------|----|
| 1.1. Overview | 24 |
| 1.2. Charging & Communication | 31 |

1.1. OVERVIEW

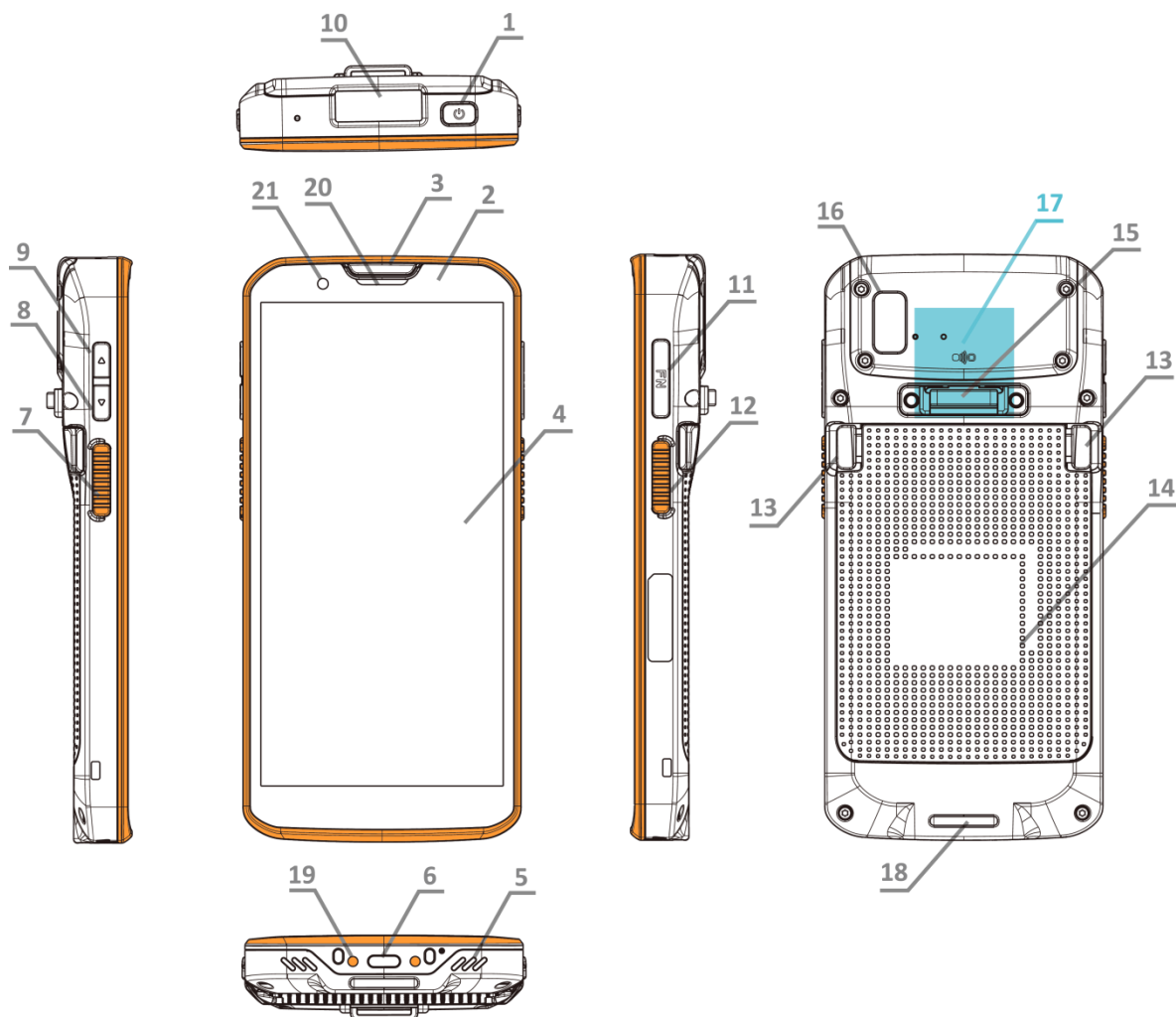

| No. | Description | No. | Description | No. | Description |
|-----|----------------------------|-----|-----------------------|-----|-------------------------|
| 1. | Power Button | 8. | Volume Down Button | 15. | Hand Strap Hole (Cover) |
| 2. | Status LED 1 | 9. | Volume Up Button | 16. | Rear Camera with flash |
| 3. | Status LED 2 | 10. | Scan Window | 17. | NFC Detection Area |
| 4. | Touchscreen | 11. | Function Key | 18. | Hand Strap Hole |
| 5. | Microphone & Speaker | 12. | Side-Trigger (Right) | 19. | Charging Pins |
| 6. | USB-C Port (USB 3.1 Gen 1) | 13. | Battery Release Latch | 20. | Receiver |
| 7. | Side-Trigger (Left) | 14. | Battery | 21. | Front Camera |

1.1.1. INSTALL/REMOVE BATTERY

For shipping and storage purposes, the mobile computer and the main battery are saved in separate packages.

Note:

- (1) Any improper handling may reduce the battery life.
- (2) Always use a fully-charged main battery for battery replacement.

To install the main battery:

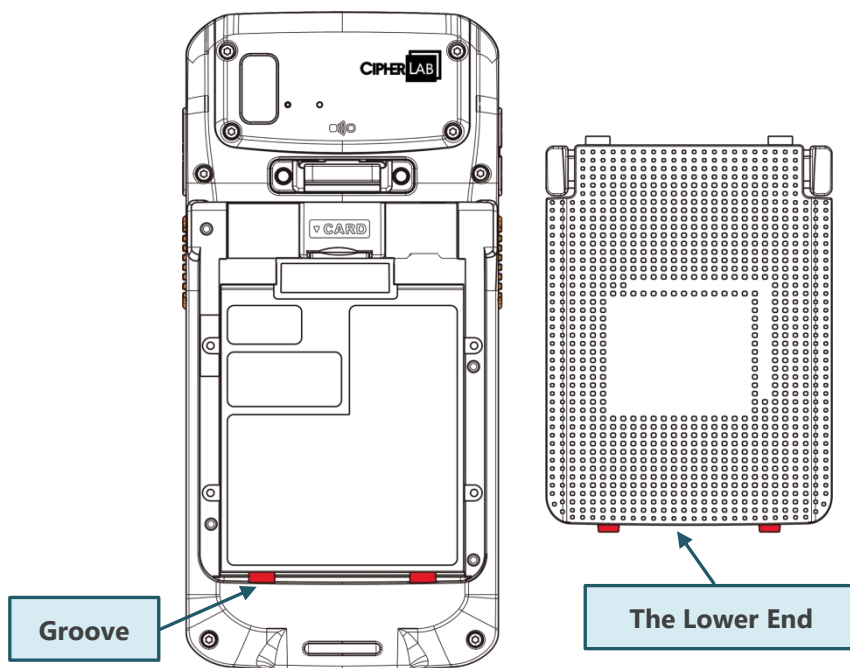

- 1) Insert the battery from the lower end into the battery compartment.

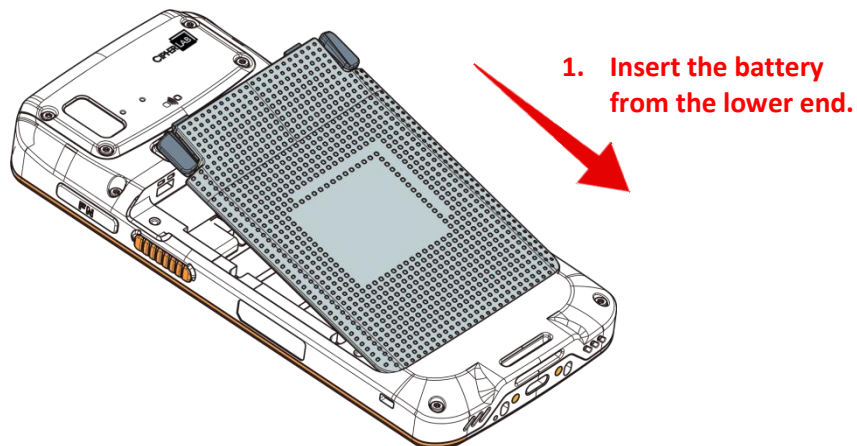

2) Simultaneously press the two release latches inward and press down on the battery.

2. Press the release latches then press down.

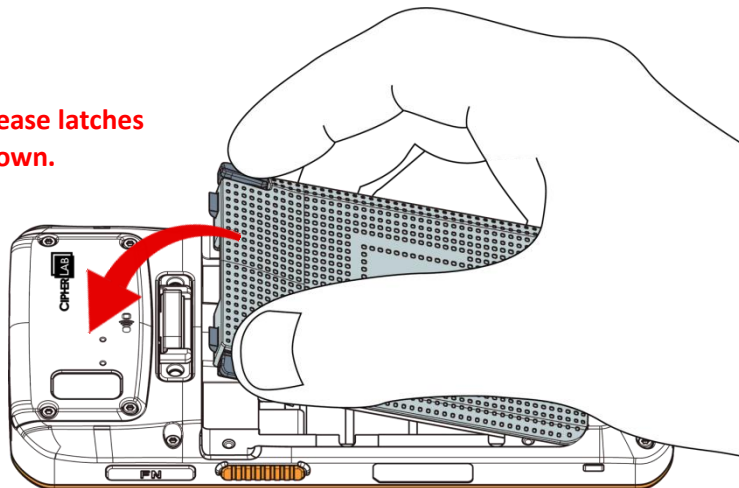

3) Press the top of the battery with your thumbs to ensure it securely snaps into place.

3. Press the upper end with your thumbs.

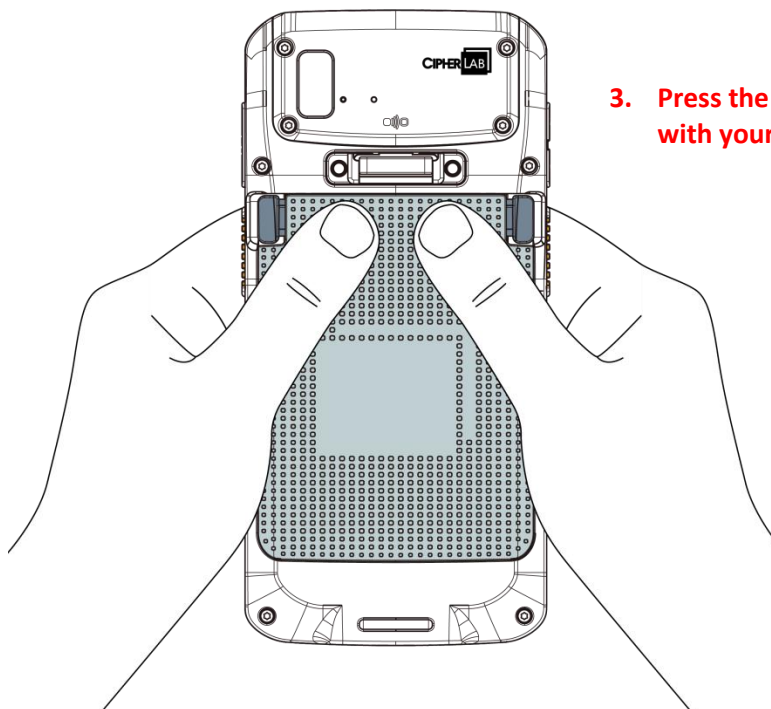

Note:

(1) For initial use, insert a fully charged battery, and then press the Power key to power on the mobile computer.

REMOVE BATTERY

To remove the battery:

- 1) Press and hold the release latches inward.

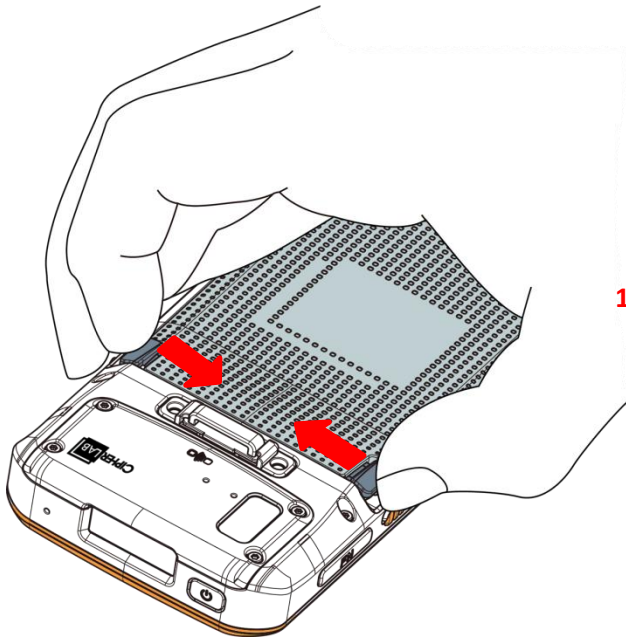

1. Press and hold the release latches inward.

- 2) Lift the battery from the device to remove.

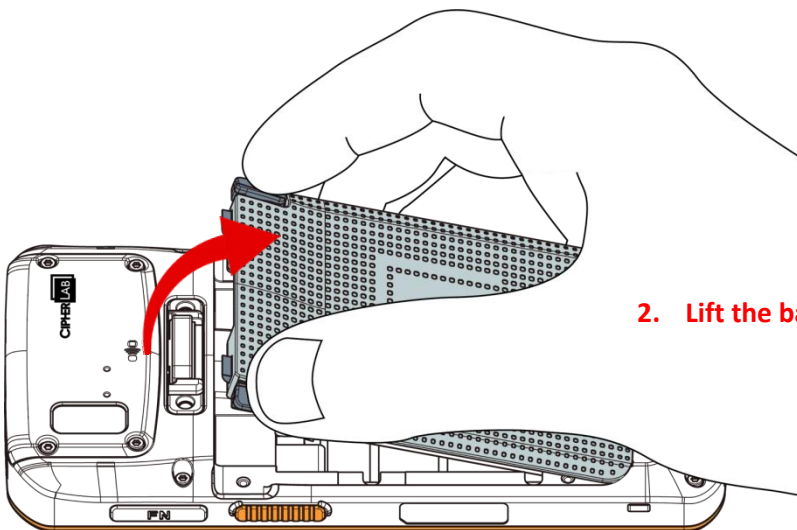

2. Lift the battery up to remove.

1.1.2. INSTALL/REMOVE SIM CARD AND MEMORY CARD

The RS38 mobile computer has a SIM card slot and a memory card slot on the hidden tray located at the top edge of the battery compartment. To access them, gently drag out the tray using your fingernail.

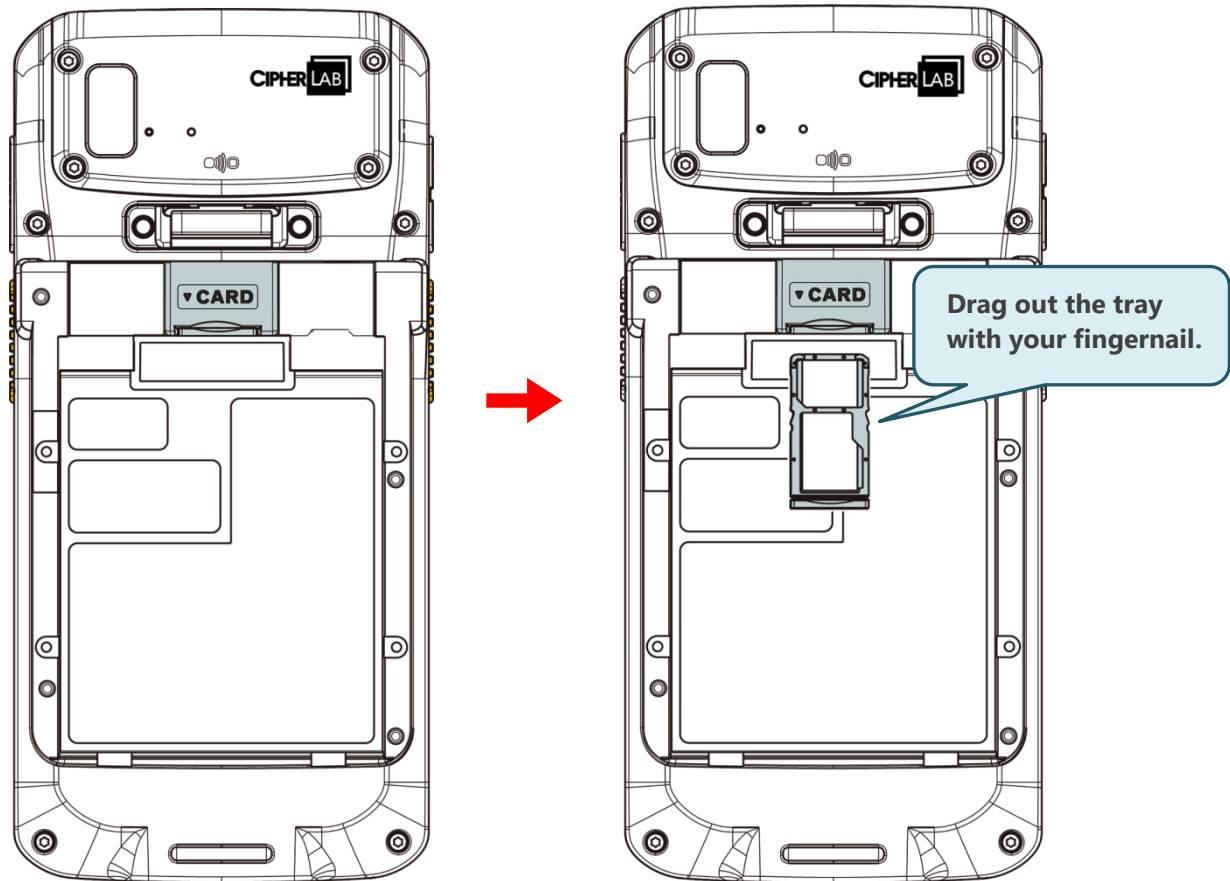

To insert the cards:

- 1) Remove the battery.
- 2) Gently drag out the tray using your fingernail.
- 3) Place the SIM card and the micro SD card into their respective slots. Notice the notches in the corner of the cards; they will only fit one way.

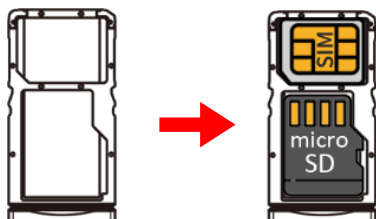

-
- 4) Insert the tray into the device in the same orientation that you removed it.

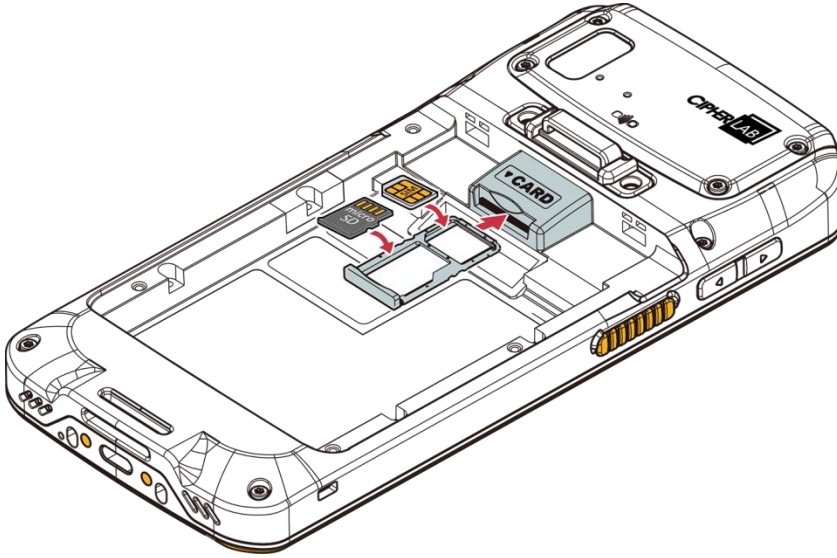

REMOVE CARDS

To remove the cards:

- 1) Remove the battery.
- 2) Gently drag out the tray using your fingernail.
- 3) Take out the cards from the slots.
- 4) Gently push back the tray into the device.

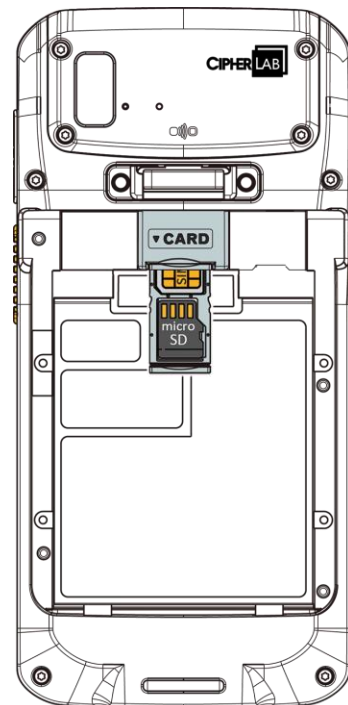

Note:

- (1) The SIM card slot exclusively supports Nano SIM cards.
 - (2) The RS38 ensures compatibility with 3G/4G/5G networks.
 - (3) The RS38 also ensures eSIM compatibility; please refer to the section [Setting up eSIM](#).
-

1.1.3. POWER ON/OFF MOBILE COMPUTER

POWER ON

To power on the mobile computer, press and hold the power button  located on the top end of the device. The mobile computer will turn on and show the **Home Screen** after splash screen.



Note: To power on the mobile computer, ensure the battery cover is securely in place.

POWER OFF

To power off the mobile computer, press and hold the power button  for more than three seconds. A menu will appear on-screen which allows you to power off the device. Make sure all user data and tasks have been stored before tapping on "**Power off**".

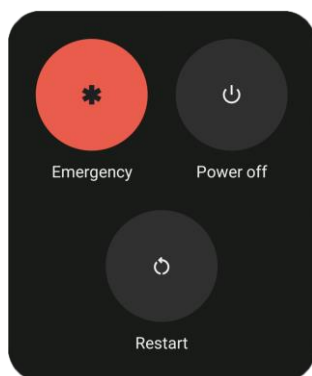

(LTE)

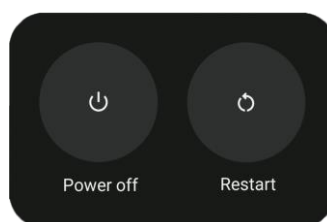

(WiFi Only)

1.2. CHARGING & COMMUNICATION

1.2.1. CHARGE THE MOBILE COMPUTER

Upon receiving the kit package, note that the main battery may not be charged to full capacity for shipment. Before using the mobile computer, it's necessary to fully charge the main battery. You can accomplish this by using the [Workstation Connect Cradle](#) along with the power adapter. Alternatively, you can charge your device using a USB Type-C cable connected to a host computer, although this method is slower than using the RS38 Workstation Connect Cradle.

CHARGING TIME

The [Main Battery](#) requires approximately 3.5 hours to be fully charged from empty, while the [Extended Battery](#) takes about 4.5 hours. The [Backup Battery](#) can be charged by either the main battery or the power adapter and typically takes around 4 hours to reach full charge.

CHARGING TEMPERATURE

The permitted battery cell temperature ranges from 0°C to 50°C. Since the system generates heat during charging, it is recommended to charge within the ambient temperature range of 0°C to 40°C.

The permitted battery charging ambient temperature ranges from 0°C to 40°C, with optimal performance achieved at room temperature from 18°C to 25°C.

OPERATION ON BATTERY POWER

When Bluetooth® Class II, v5.2 dual mode, v2.1 with EDR (Enhanced Data Rate), IEEE 802.11 a/b/g/n/ac/ax/d/h/i/r/k/v/w/mc (802.11ax only on WIFI 6 model) networking technologies, GSM/UMTS/WCDMA/HSPA/HSPA+/LTE/VOLTE, and GPRS/EGPRS are all enabled on battery power, the main battery level will drop down substantially. Prolonged use of the display and continued scanning of barcodes will also affect battery level.

To ensure that the system does not shut down due to a drained battery, we recommend either keeping a spare, fully charged battery for replacement at all times or connecting the mobile computer to an external power source.

BATTERY STATUS & STATUS LED DURING CHARGE

When the RS38 mobile computer is connected to an external power source, the Status LED located in the upper-right corner of the touch screen displays as follows:

| LED Status | Description |
|-------------------|---|
| Breathing Red | Charging the mobile computer (0% to 90%) |
| Breathing Green | Charging the mobile computer (91% to 99%) |
| Solid Green | Charging complete (100%) |
| Blinking Red | Charging error (e.g., charging temperature lower than 0°C or exceed 40°C) |

WORKSTATION CONNECT CRADLE

The RS38 Workstation Connect Cradle is available in two models: the **WCCN Model**, facilitating both charging and data transmission, and the **CHCN Model**, designed specifically for charging purposes. Equipped with a main charging station for the RS38 mobile computer and a spare battery compartment, the RS38 Cradle offers added convenience for charging needs.

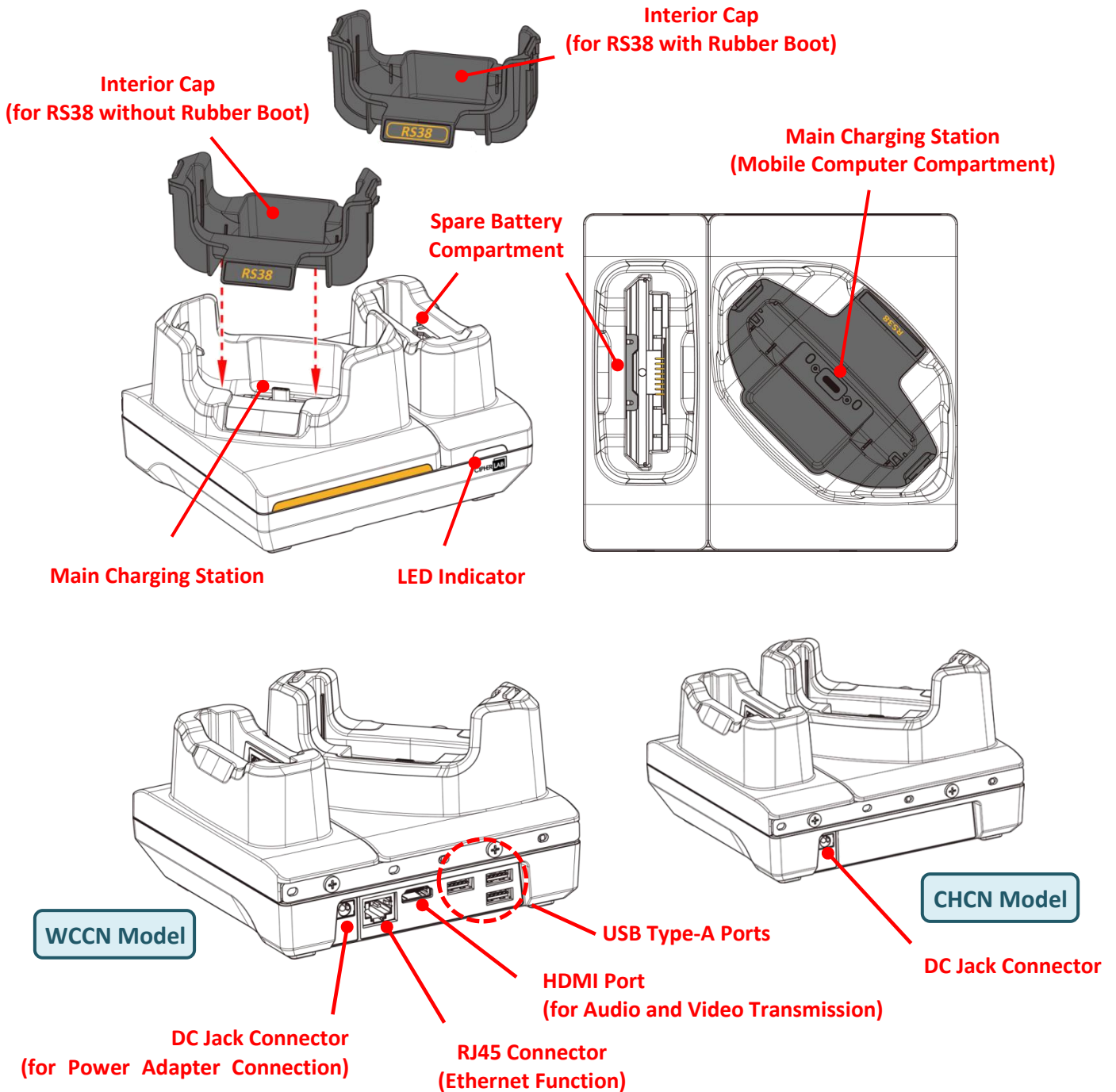

To charge your mobile computer using the RS38 Workstation Connect Cradle:

- 1) Disconnect the USB Type-C cable from the RS38 mobile computer if it is currently connected.
- 2) Insert the appropriate interior cap depending on whether you are charging with or without the rubber boot.

To charge with the **rubber boot**, choose the interior cap with a **yellow frame**.

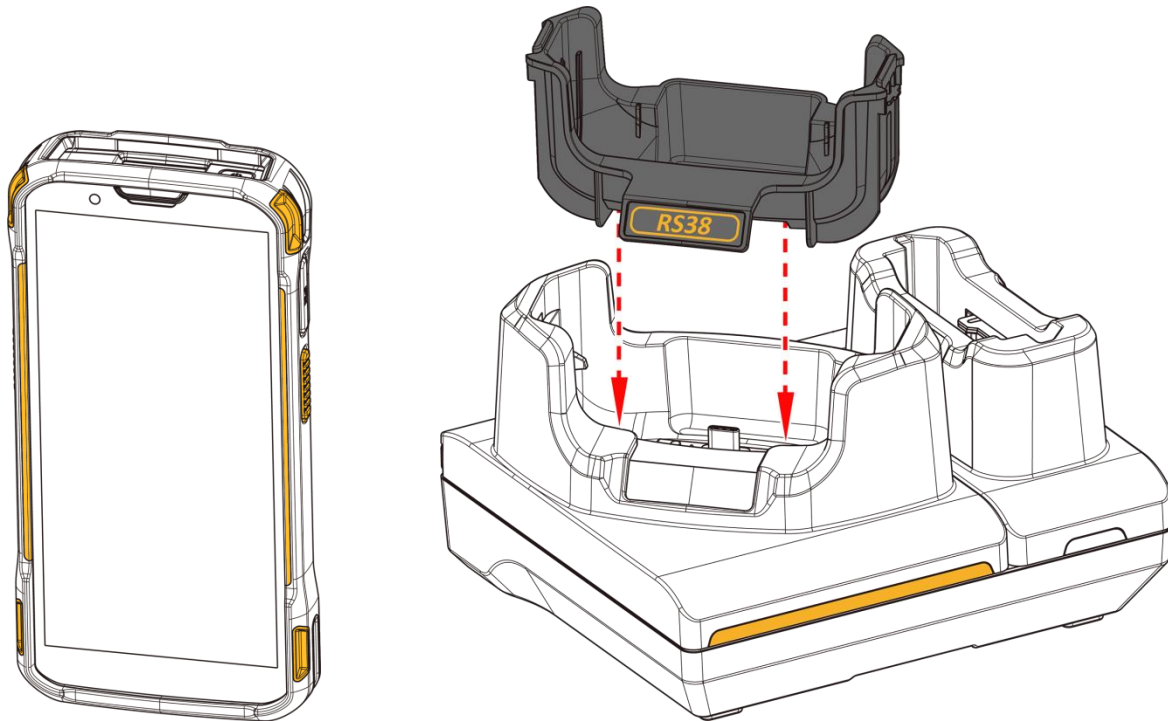

Note:

Insert the appropriate interior cap into the RS38 Workstation Connect Cradle to enable charging for the RS38 mobile computer, regardless of whether a rubber boot is attached.

To charge **without** the **rubber boot**, choose the interior cap without a frame.

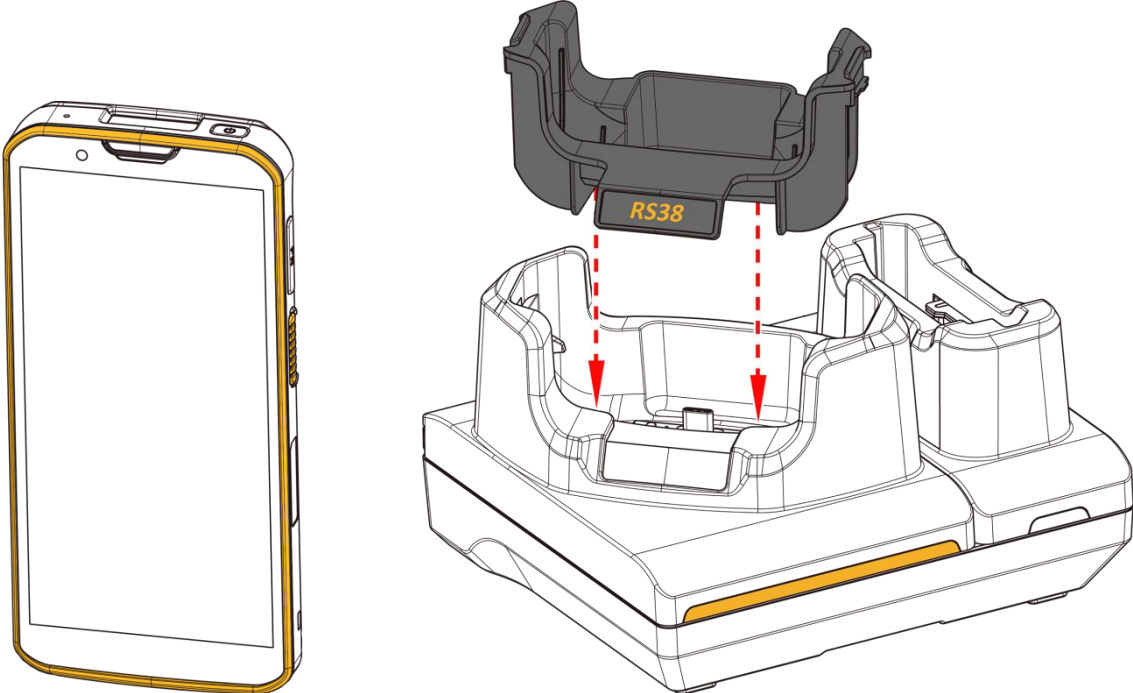

3) Insert the RS38 mobile computer onto the Cradle.

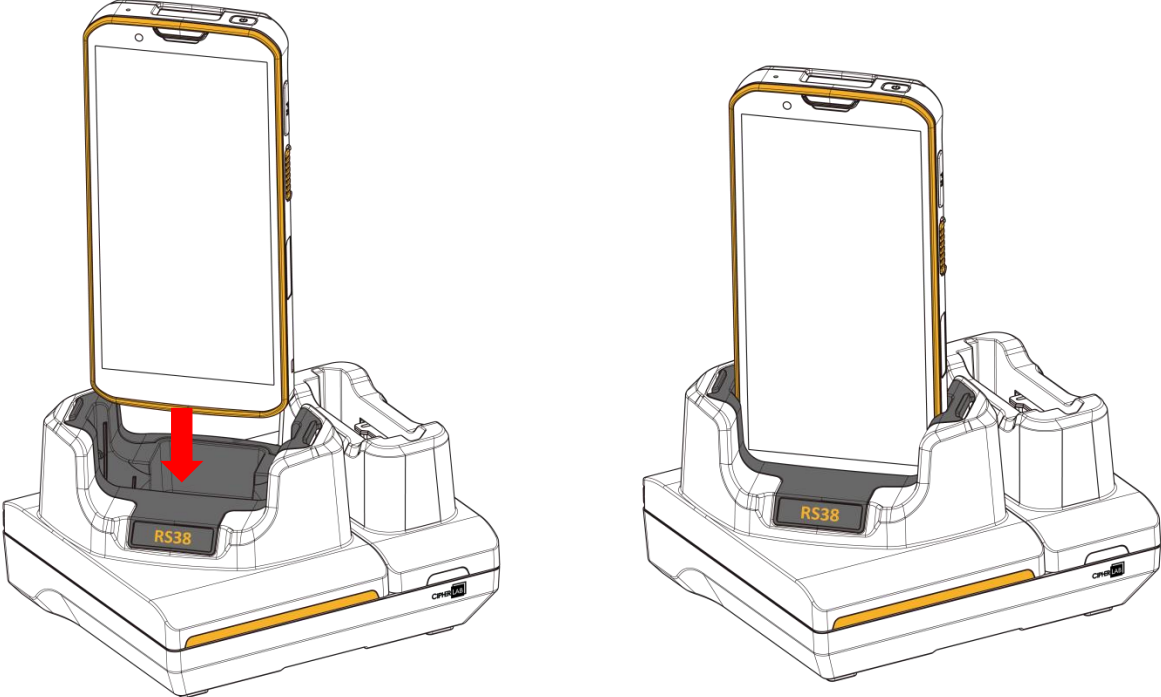

To remove, simply take the device out.

- 4) Place the battery into the spare battery compartment of the cradle, making sure the side with the release latches faces downward. Press down to secure it into place.

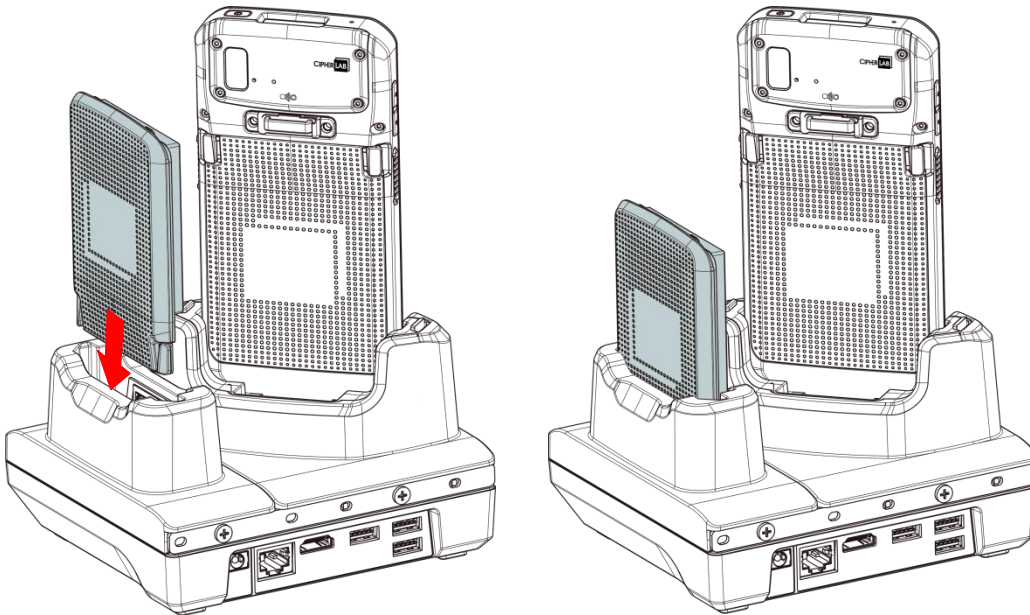

To remove the device or the battery, simply lift it out from the cradle.

To replace or move the interior cap, use your thumbs to press inward on both sides of the interior cap, then lift upward.

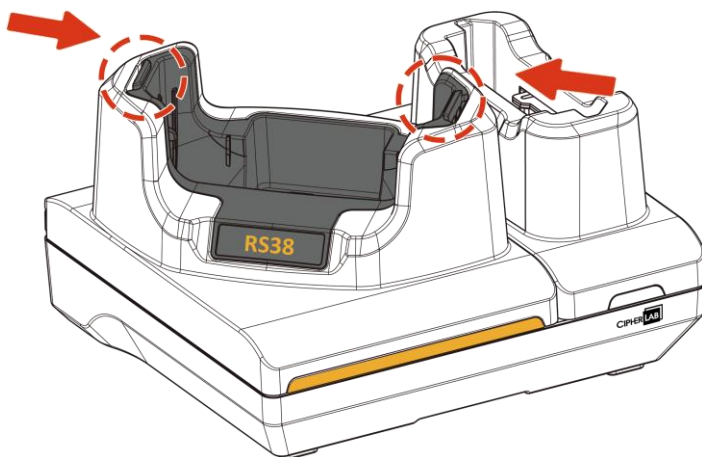

5) Connect the adapter to the Cradle, and plug the other end into an electrical outlet.

The mobile computer displays its own charging status, while the spare battery's charging status is indicated by the **LED on the Cradle**. Refer to the table below for the spare battery's charging information.

LED on the RS38 Mobile Computer:
Indicates the charging status of the main battery.

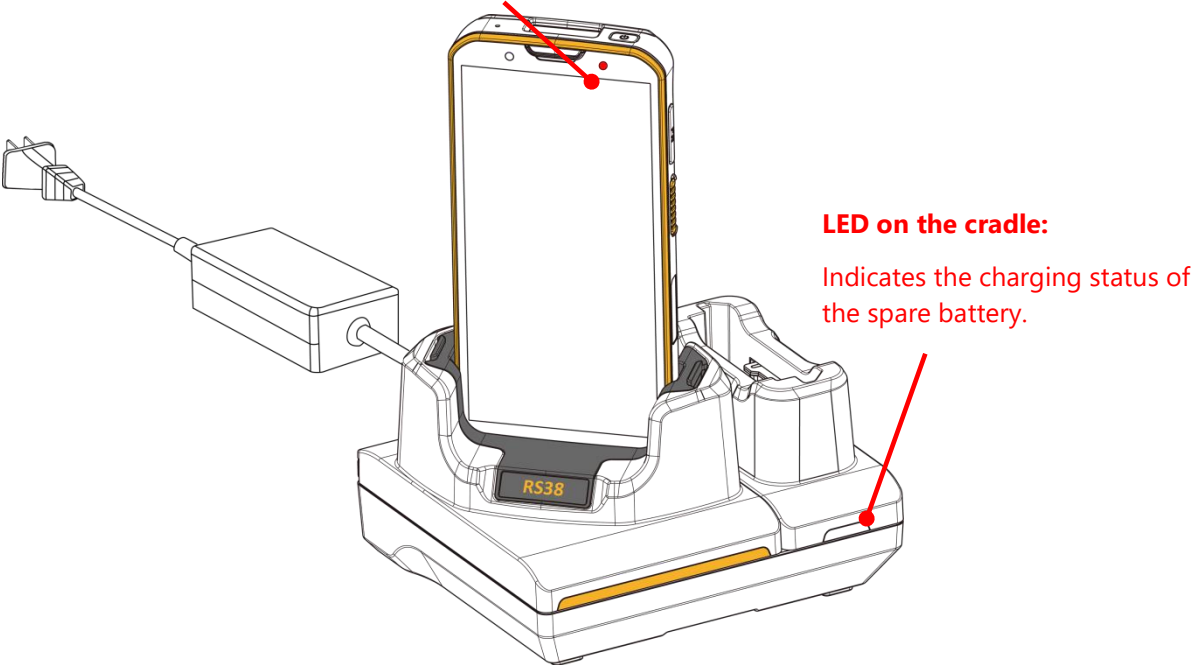

| Cradle LED Indicator | Status | Description |
|-----------------------------|-----------------|-----------------------------------|
| Charging | Breathing Red | Charging the battery (0% to 90%) |
| | Breathing Green | Charging the battery (91% to 99%) |
| | Solid Green | Charging complete (100%) |
| | Blinking Red | Charging error; Not charging |

Note:

- (1) Non-charging issues may result from battery damage, a poor connection, or a dislodged AC plug.
- (2) Charging error might occur due to elevated battery temperature.

1.2.2. WIRED DATA TRANSMISSION

Use a USB Type-C cable to connect the mobile computer to your PC for data transmission.

- 1) Connect your device to the computer with a USB Type-C cable or Cradle.

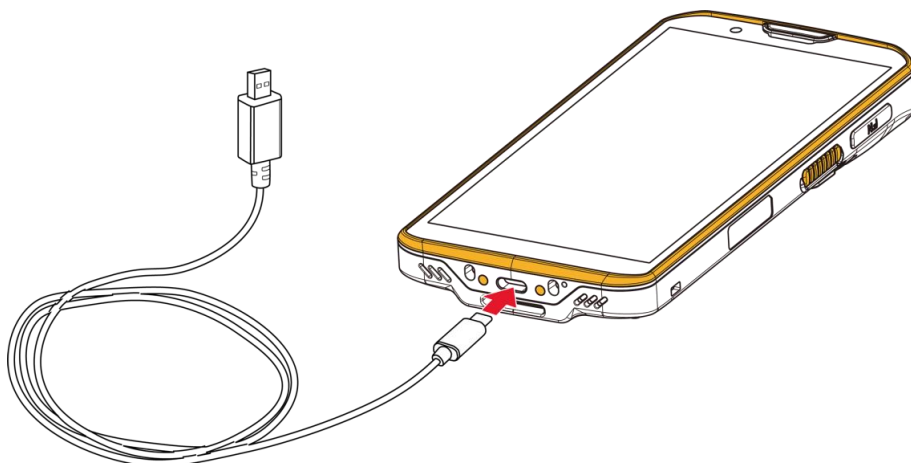

- 2) Once connected, the “**USB Preferences**” page will appear. By default, the device is set to charging mode, indicating a “**No data transfer**” status. In this mode, accessing files on the device from the PC client is not possible.

- ▶ To transfer all types of files between your device and PC, choose “**File Transfer**”.
- ▶ To activate the sharing of the RS38’s internet connection with the connected PC, select “**USB tethering**”.
- ▶ To connect and communicate with MIDI-enabled devices, select “**MIDI**”.
- ▶ To transfer videos and photos, select “**PTP**”. This mode allows your device to share only videos and photos located in DCIM and Pictures folders.

To compress and encode videos into AVC format, tap to enable “**Convert videos to AVC**”.

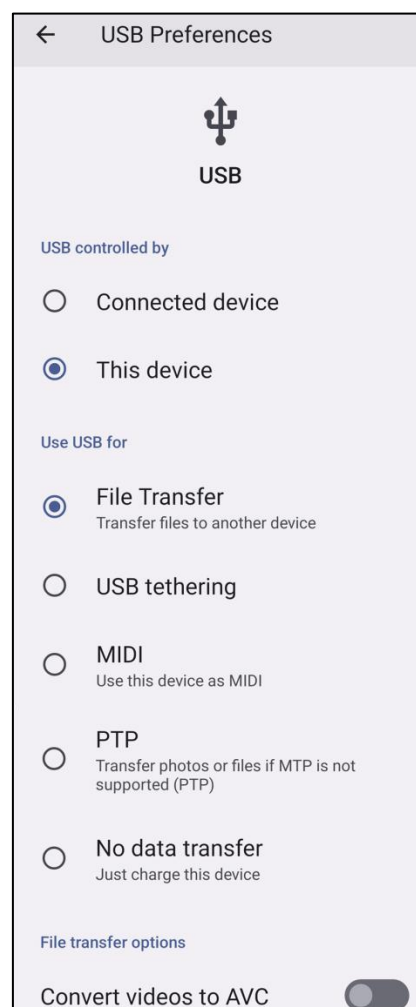

To modify USB settings after exiting the "USB Preferences" page, swipe down from the status bar to access the [Notifications Drawer](#). Then, tap the relevant system notification regarding USB usage to modify USB settings further.

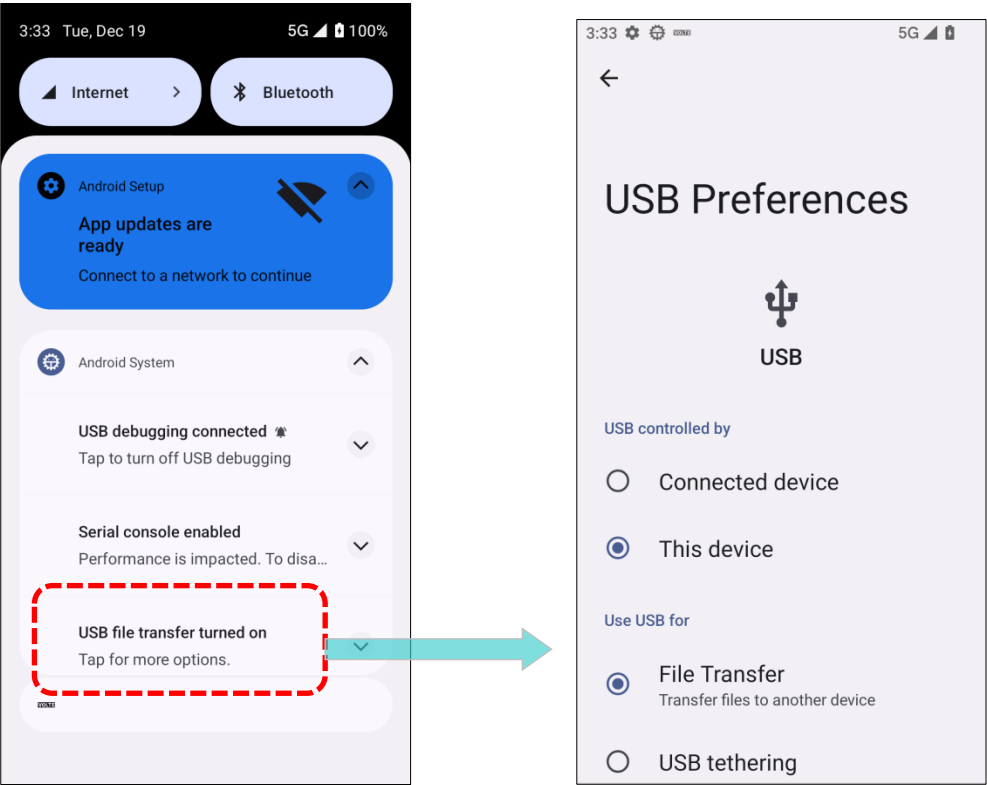

1.2.3. USING WIRELESS NETWORKS

The mobile computer supports widely applied wireless technologies, including Bluetooth® Class II, v5.2 dual mode, and v2.1 with EDR (Enhanced Data Rate), enabling efficient real-time data transmission.

It also features select GSM/UMTS/WCDMA/HSPA/HSPA+/LTE/VOLTE modules for comprehensive data and voice communication.

Chapter 2

CHAPTER 2. USING THE RS38 MOBILE COMPUTER

This chapter walks you through the fundamental usage and features of this device.

IN THIS CHAPTER

| | |
|-------------------------------------|----|
| 2.1. Battery | 41 |
| 2.2. Memory..... | 57 |
| 2.3. Touch Screen | 71 |
| 2.4. Notifications..... | 80 |
| 2.5. Date and Time | 87 |
| 2.6. Language & Keyboard Input..... | 91 |
| 2.7. Sound and Volume..... | 96 |
| 2.8. Data Capture..... | 96 |

2.1. BATTERY

MAIN BATTERY

The main battery powers the mobile computer with a rechargeable 3.87V, 4000mAh Li-Polymer battery pack, requiring approximately 3.5 hours to fully charge from empty. While charging, the LED above the screen will light up in breathing red light, transitioning to breathing green when the capacity reaches over 90%. Once fully charged, the LED becomes solid green, indicating that the charging process is complete.

EXTENDED BATTERY

The extended battery is an optional rechargeable 3.87V, 6000mAh Li-Polymer battery pack, requiring approximately 4.5 hours to fully charge from empty. While charging, the LED above the screen will light up in breathing red light, transitioning to breathing green when the capacity reaches over 90%. Once fully charged, the LED becomes solid green, indicating that the charging process is complete.

BACKUP BATTERY

The backup battery is a rechargeable Li-Polymer mounted on the main board and serves to maintain the mobile computer in suspension during battery hot-swapping, ensuring data retention for 10 minutes when the battery is fully charged and with inactive wireless modules. Additionally, the Real-Time Clock (RTC) is also powered by the backup battery for at least 72 hours when the main battery is removed.

The backup battery can be charged by the main battery and takes approximately 4 hours to reach full charge. When the backup battery voltage drops below 3.9V, the main battery will automatically charge the backup battery, even without the charger connected.

Note:





- (1) For optimal performance, fully charge a new battery before use.
 - (2) To avoid data loss when replacing the main battery, use a fully charged spare battery pack.
 - (3) To avoid a system crash, the system will NOT resume from suspend mode if the power of the installed main battery is less than 10%.
-

2.1.1. BATTERY STATUS INDICATORS

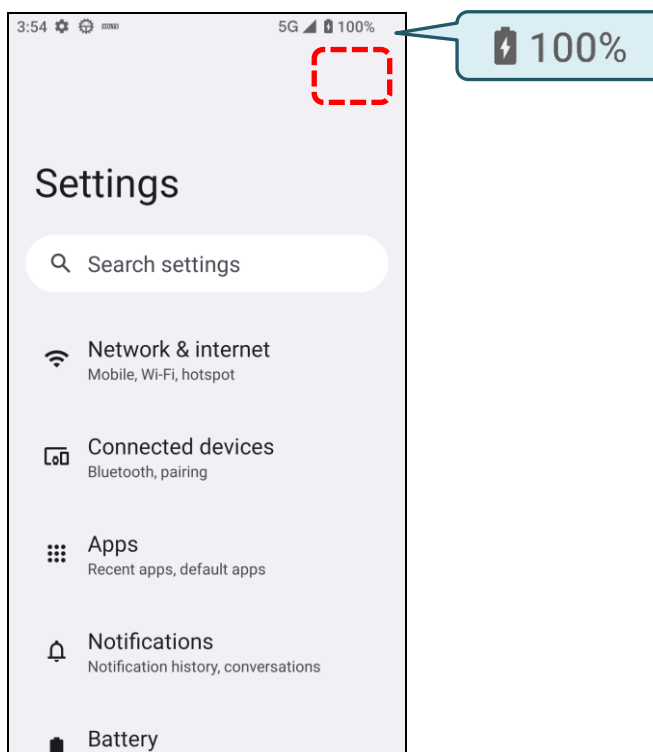
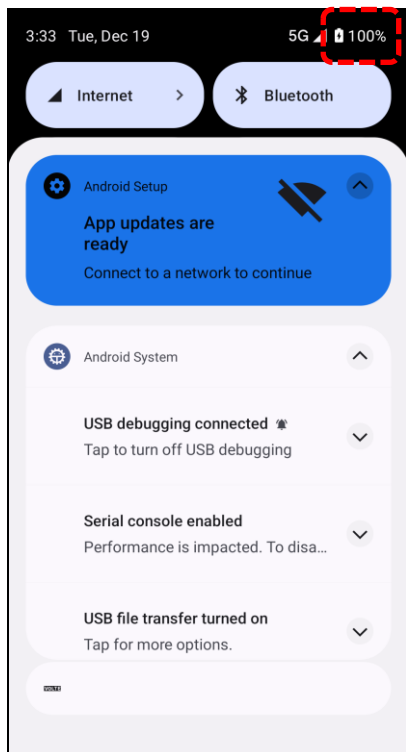
The main battery pack serves as the sole power source for the mobile computer’s proper functioning. Therefore, when the main battery level becomes low, promptly replace the battery pack with a charged one or initiate the charging process. Most importantly, regularly save important data to prevent potential loss.

You can check the remaining battery level by looking at the **battery status icon** on the **Status Bar**.



| Battery Icon | Description |
|---|---|
|  | Main battery is fully charged. |
|  | Main battery level is partially drained. |
|  | Main battery level is low (5%~15%). |
|  | Main battery level is very low and needs charging immediately (<5%). |
|  | External power source is connected and main battery is being charged. |

The percentage beside the battery icon on the status bar can be switched on or off in [App Drawer \(All](#)

[Apps\)](#) | **Settings**  | **Battery**  | **Battery Percentage.**

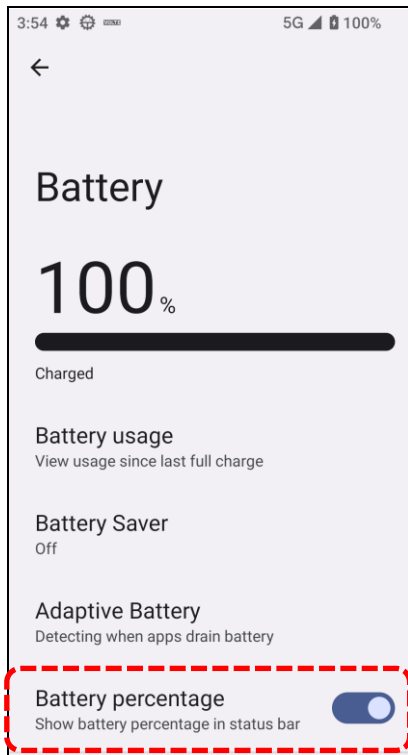

Warning:

- (1) Once the battery level drops below 15%, the low battery notification will be displayed on the screen.
 - (2) Constant usage of the mobile computer at low battery level can affect battery life. For maximum performance, recharge the battery periodically to avoid battery drain out and maintain good battery health.
-

2.1.2. MONITOR BATTERY LEVEL

MAIN BATTERY LEVEL

To check main battery level, please go to [App Drawer](#) | [Settings](#)  | [Battery](#) 

The battery level percentage provides a clear indication of the remaining battery power. Tap on **"Battery usage"** to view the usage since last full charge, including the battery discharge rate, the duration of operation on the battery power, and the most power consuming applications.

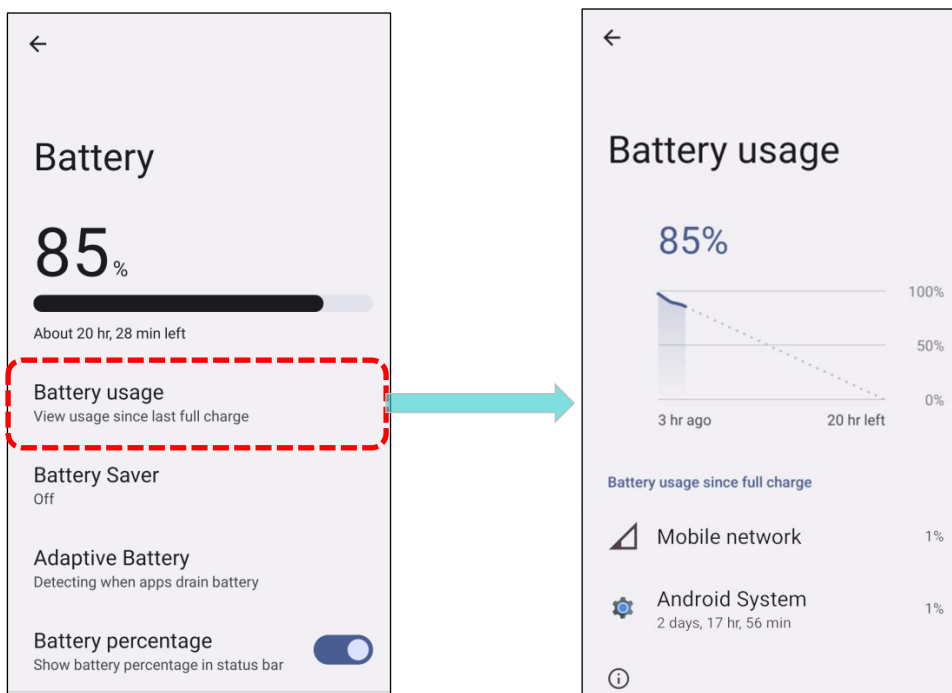

BATTERY SAVER MODE

Enabling “**Battery Saver**” conserves energy by restricting power-intensive features, such as location services, vibration, and most background processing data, especially when the main battery is low.

To **schedule automatic activation** of the Battery Saver mode:

- 1) Tap “**Battery Saver**” on Battery page and then tap on “**Set a schedule**”.

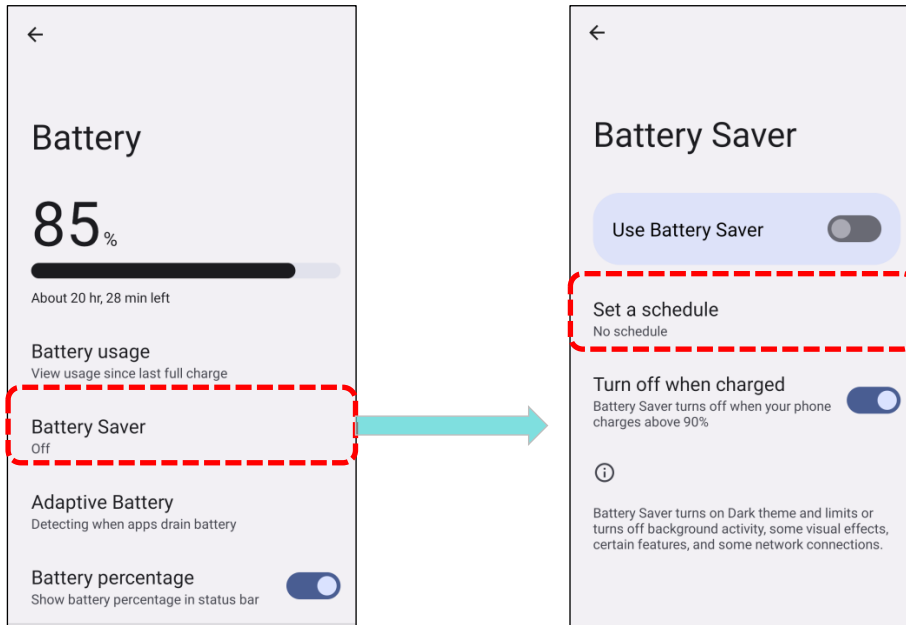

- 2) Tap the “**Based on percentage**” radio button, then use the slider to set the desired battery power percentage for enabling Battery Saver mode; the default setting is 10%.

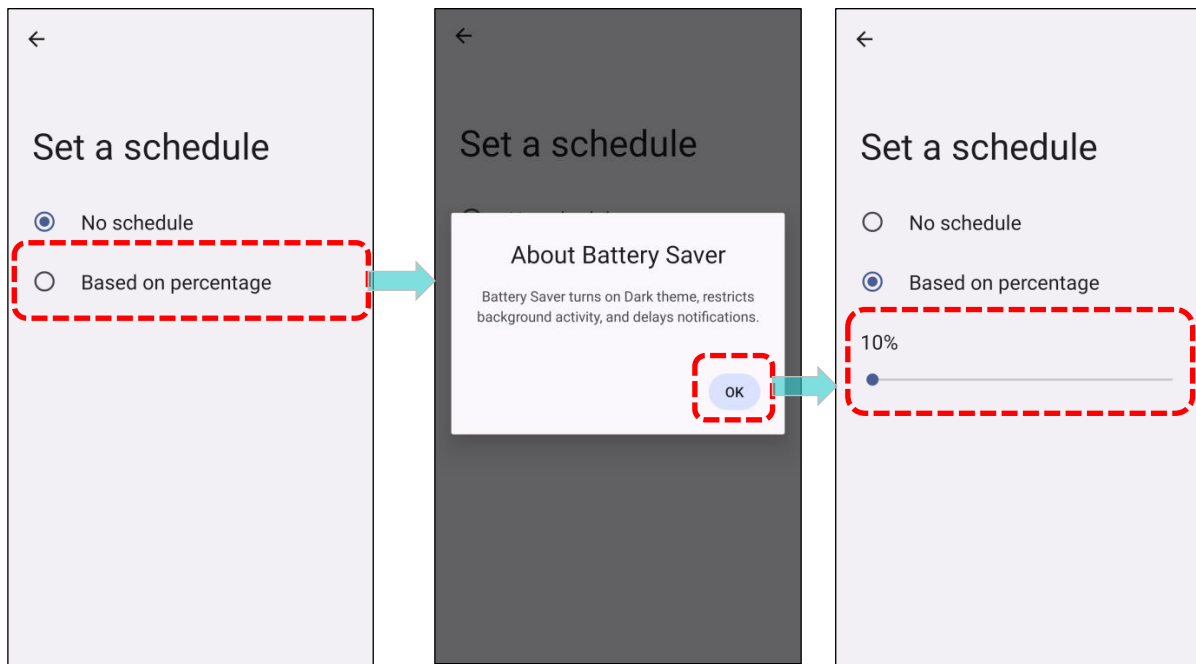

To **manually** activate Battery Saver mode:

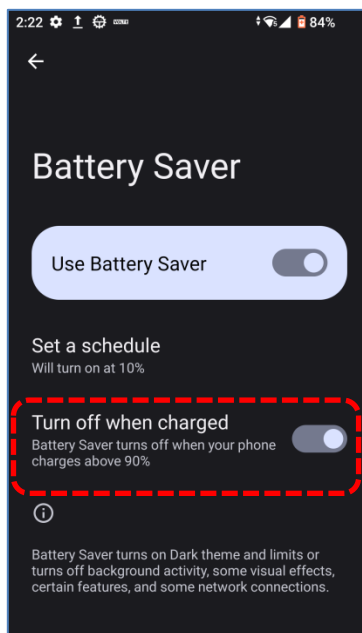
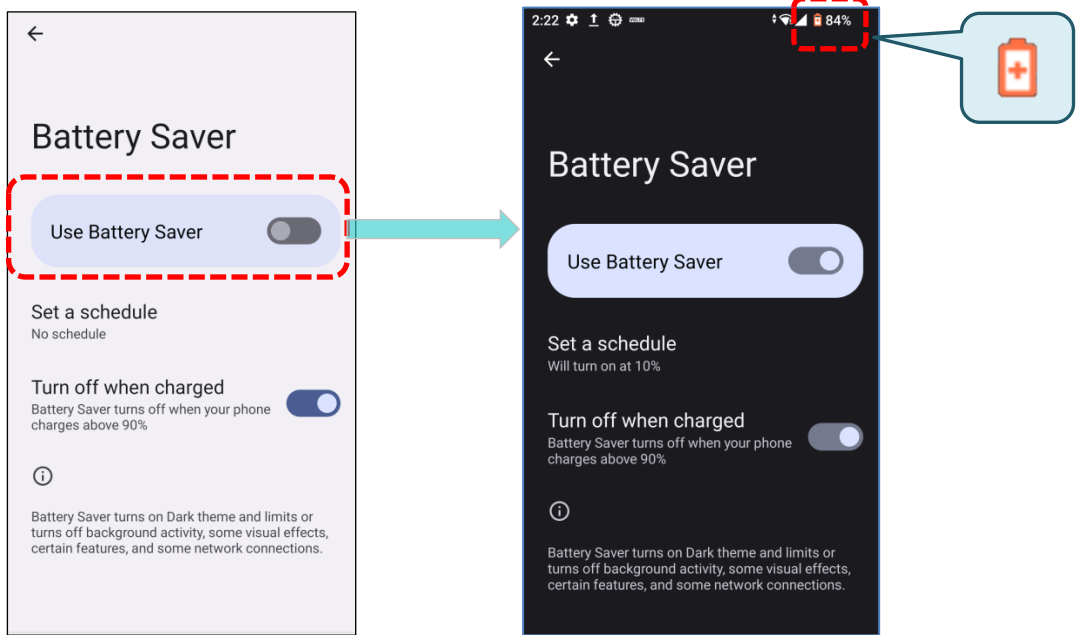

- 1) Tap "**Use Battery Saver**" to activate the battery saver function; the battery icon on the status bar will turn orange upon enabling this feature.

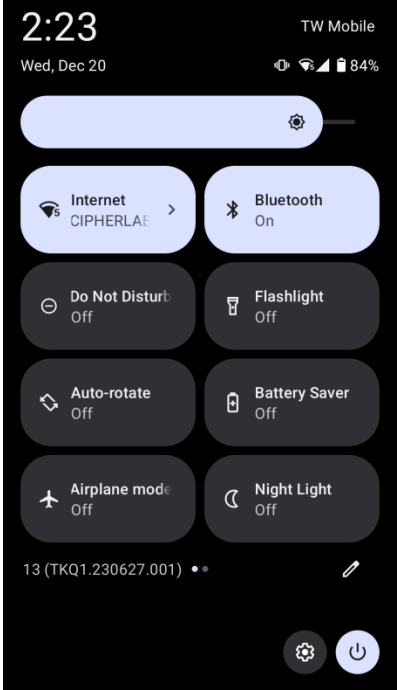
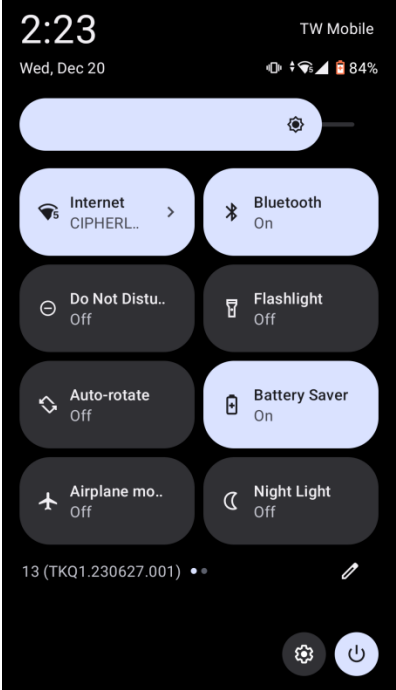

Enabling "**Turn off when charged**" automatically deactivates Battery Saver mode once the battery is charged to 90%.

You can also swipe down from the status bar to reveal the **Quick Settings Panel** or **Quick Settings Menu**, then tap the **Battery Saver** icon  to enable or disable it.



| Icon | Description |
|---|------------------------------------|
|  | Battery saver mode is OFF . |
|  | Battery saver mode is ON . |

Note:

Battery Saver mode automatically **deactivates** when your device is charging, as indicated by **“Unavailable”** in the following picture on the Quick Setting Panel.

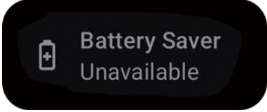

BATTERY OPTIMIZATION

With **Battery optimization** enabled for applications, you can ensure that they remain inactive when your device is idle or hasn't been used for days.

To enable battery optimization for specific apps:

- 1) Tap "**Battery usage**" on the Battery page.
- 2) Tap on specific apps under "**Battery usage since full charge**" to enter its detail page.
- 3) Select "**Optimized**".

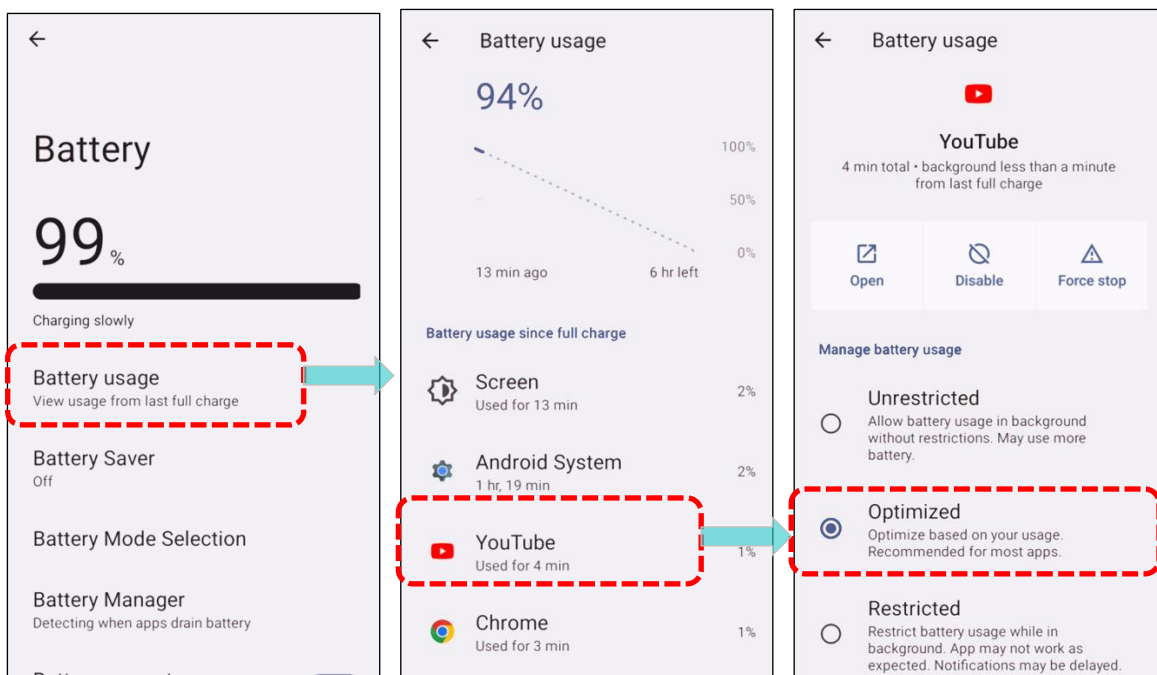

LOW BATTERY ALERT

When the main battery level drops to 15% and 5%, the mobile computer will display a warning notification reminding you to charge it.

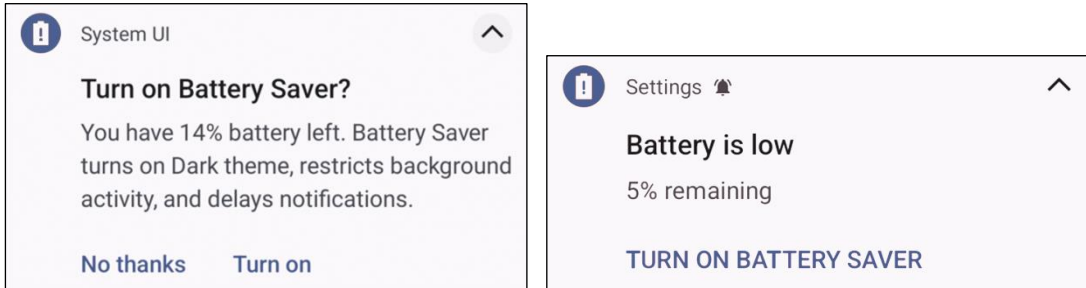

You can take immediate action by enabling [Battery Saver Mode](#), connecting the mobile computer to an external power source, or replacing the main battery pack.

LOW SUB BATTERY ALERT

When the main battery's power is drained out, the RS38 mobile computer will automatically suspend using the backup battery's power for 10 minutes. If the backup battery's power is low, the "**Low Sub Battery**" notification will prompt you to connect the device to an external power source for immediate charging.

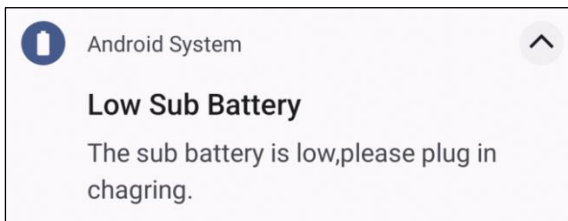

Note:

Please refrain from replacing the main battery when receiving a low sub-battery alert, as it may result in data loss.

2.1.3. REPLACE MAIN BATTERY

When the main battery level is low, follow the steps below to replace a fully charged battery for replacement.

SHUT DOWN TO REPLACE THE MAIN BATTERY

To replace the main battery:

- 1) Make sure the sub battery and the new main battery are fully charged.
- 2) Press and hold the **power button** on the top end of the mobile computer.

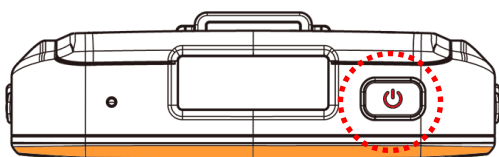

Power Button

- 3) Tap **"Power off"** in the pop-up menu. The mobile computer will power off.

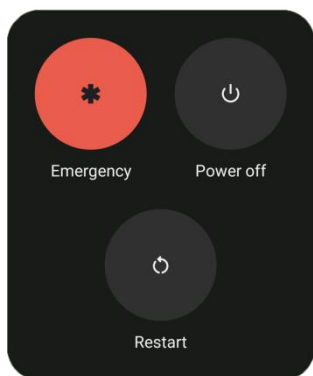

- 4) Follow the steps as [Install/Remove Battery](#) describes to remove the main battery and replace it with the new one.

Note: Turn off the power before replacing the main battery, except for hot-swapping the battery.

BATTERY SWAP

RS38 backup battery provides system power during a battery swap. When the battery cover is removed, the system enters suspend mode and won't resume until the battery cover is reattached and the power button is pressed. Please refer to "[Low Sub Battery Alert](#)" section to ensure the sub battery is fully charged before initiating the battery swap process.

The main battery hot swap is viable within a temperature range of 0°C to 50°C. Throughout the battery swap process, Wi-Fi and Bluetooth connections remain active for approximately 30 seconds.

Follow the steps below to initiate a battery swap:

- 1) Make sure the backup battery is in good condition and that the system is in low power consumption when possible. For example, close unnecessary apps like the camera, flashlight, and high-volume audio player.
- 2) Directly remove the main battery. The screen turns off, and the system enters suspend mode.
- 3) Once the main battery is removed, replace it with a fully charged one as soon as possible.
- 4) Install a fully charged main battery by following the steps described in [Install/ Remove Battery](#).
- 5) Ensure the main battery is properly installed before pressing the power button to wake up the mobile computer from suspend mode.

Warning:

Please refrain from performing a battery swap before the mobile computer's operating system is fully ready. Removing the battery cover during the device's power-up process may lead to system failure.

Note:

- (1) Make sure to remove the AC or USB Type-C cable before proceeding with the Battery Swap.
- (2) Backup battery keeps the mobile computer in suspension when the main battery is depleted. Thus, to prevent data loss, DO NOT replace the main battery when backup battery's power is low. Connect the RS38 mobile computer to an external power source and charge it until the "Low Sub Battery" notification icon disappears from the status bar. Once the notification disappears, you can proceed with the main battery replacement.

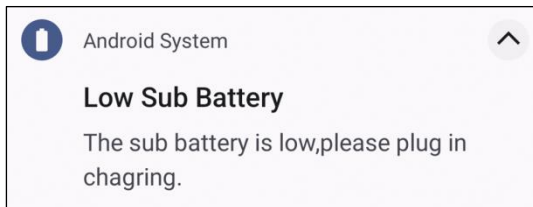

2.1.4. POWER MANAGEMENT

Efficient power management is crucial for portable devices, particularly during travel. Here are some tips to help you conserve battery power.

- Carry an extra main battery pack with you on the road.
- Disable wireless connections (such as **Bluetooth, Wi-Fi, NFC** and **GPS**) when not in use.
- Adjust the screen off time. Please refer to [Screen Timeout Settings](#).
- Reduce the screen brightness level. Please refer to [Screen Brightness](#).
- Activate [Battery Saver](#) mode and [Battery Optimization](#) mode.
- If your Google Account is signed in on this device, you can turn off specific automatic data syncing for applications like **Email, Calendar**, and **Contacts**.

Go to [App Drawer](#) | [Settings](#)  | [Passwords & accounts](#)  | [your Google Account](#)

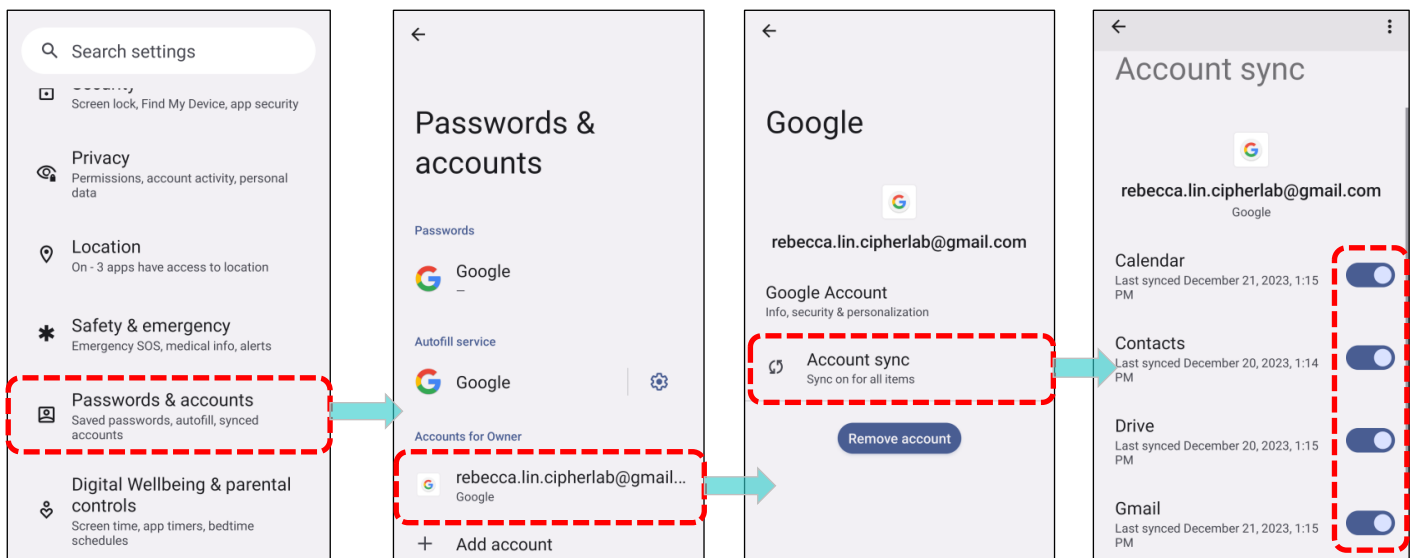

Warning:

Using backlight, wireless connectivity, and peripheral devices while on battery power will substantially reduce battery power.



ENTER AIRPLANE MODE

Activating **Airplane mode** on your device disables all wireless radios, including call functions and data connections like Bluetooth, Wi-Fi, and 3G/4G/5G, leading to significant battery power savings.

To enter Airplane mode:

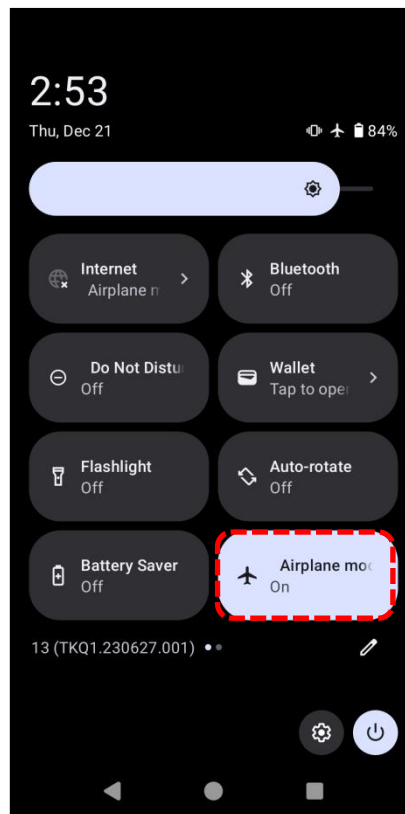
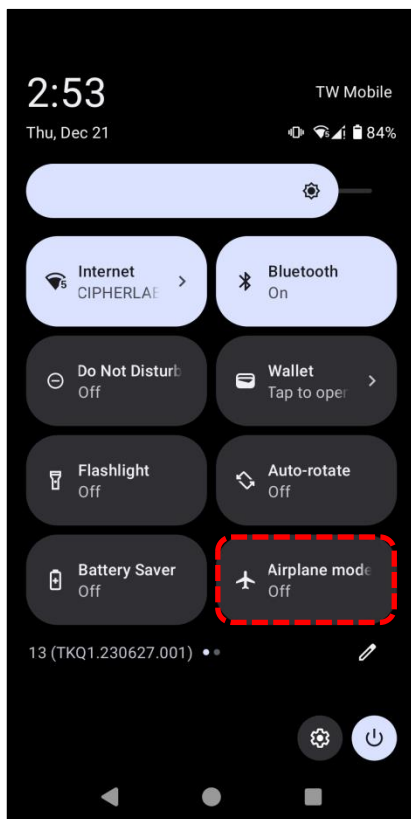
- 1) Swipe down from the top of the screen to open [Quick Settings Menu](#).
- 2) Tap on the **Airplane** mode icon to enable/disable the mode.



| Icon | Description |
|---|-------------------------------|
|  | Airplane mode is OFF . |
|  | Airplane mode is ON . |

2.1.5. BATTERY PRECAUTIONS

To preserve battery life and prevent battery bulge:

- Avoid using your device while continuously connected to a power supply or charging cradle.
- Refrain from repeatedly connecting your RS38 mobile computer to a power supply or charging cradle if the main battery is fully charged.

BATTERY TEMPERATURE ANOMALY

High ambient temperature or continuous use of the RS38 mobile computer while charging may cause the battery temperature to rise. For safety, the RS38 will automatically suspend battery charging or shut down until the battery temperature returns to normal levels.

If the battery temperature reaches **55°C**, an "**Over Battery Temperature**" warning will prompt you to remove the battery. Additionally, the RS38 will automatically shut down if the battery temperature reaches **58°C**, as the battery cannot discharge at such high temperature.

- At 55°C

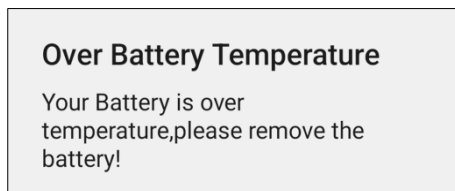

- At 58°C

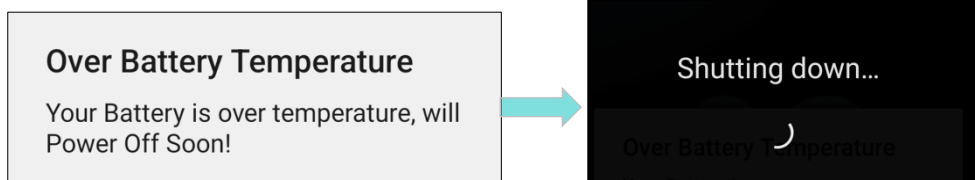

Using the RS38 mobile computer under a low-temperature environment may result in the device shutting down automatically. If the battery temperature drops to **0°C** or lower while charging, the red Status LED on the front panel will blink, accompanied by a warning window. This serves as a reminder for the user to disconnect the charger, and the RS38 mobile computer will automatically suspend battery charging.

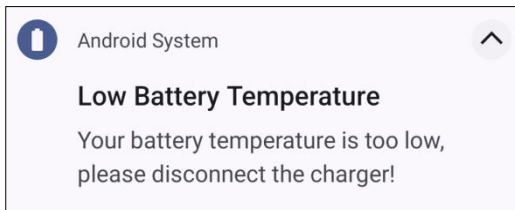

To preserve battery life, it is recommended to promptly unplug the charger and charge your RS38 mobile computer under appropriate temperature conditions.

2.2. MEMORY

- Flash Memory (ROM)

The **128GB** flash memory is designed for storing the OS (Android 13) and custom application programs.

- Random-access Memory (RAM)

A 8GB RAM configuration is suitable for both storing and running programs, as well as storing program data.

- Expansion Slot

The mobile computer features a single SD card slot which can accommodate a **microSDHC** (up to **32GB**) or a **microSDXC** (up to **1TB**). When selecting an SD card for optimal compatibility and performance with the RS38, please make sure it meets your required capacity. If using an SDXC card, use a new card and ensure it hasn't been previously used in other host devices such as computers, cameras, or readers.

CAUTION OF DATA LOSS

When the main battery is removed or drained, the backup battery on the main board takes over to supply the mobile computer and keep it in suspension. A fully charged backup battery will retain the data for **10 minutes**. When the backup battery is also depleted, the mobile computer will shut down, and only the contents of RTC will be retained. All other unsaved data will be lost.

If you plan to store the mobile computer for a few days, be aware that data loss can occur if both the main and backup batteries discharge completely. Therefore, it's essential to back up your data and files before storing the mobile computer.

2.2.1. CHECK MEMORY USAGE

The memory manager provides an overview of the device's RAM usage. To check memory usage, enable **"Developer Option"** in advanced.

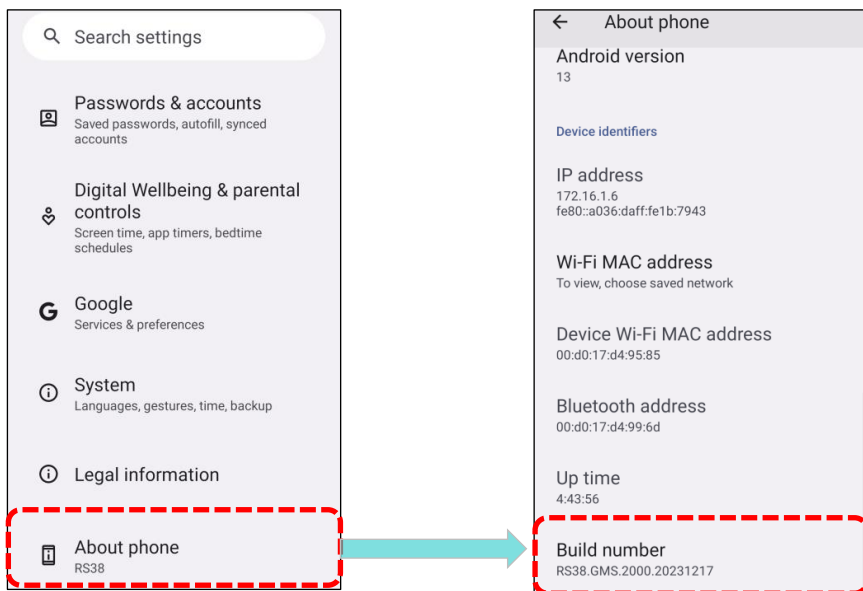

ENABLE DEVELOPER OPTIONS

- 1) To enable **"Developer options"**, go to [App Drawer \(All Apps\)](#) | **Settings**  | **About Phone** , and swipe to the bottom to find **"Build number"**.



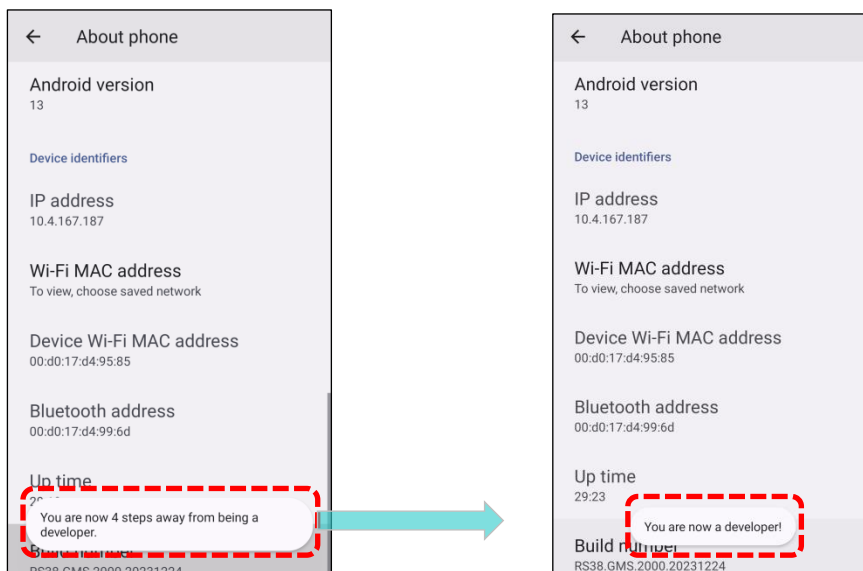

- 2) Tap **"Build number"** seven times to enable developer mode. You'll see a prompt with a countdown reading **"You are now X steps away from being a developer."** Once the prompt **"You are now a developer!"** appears, you have successfully entered developer mode.

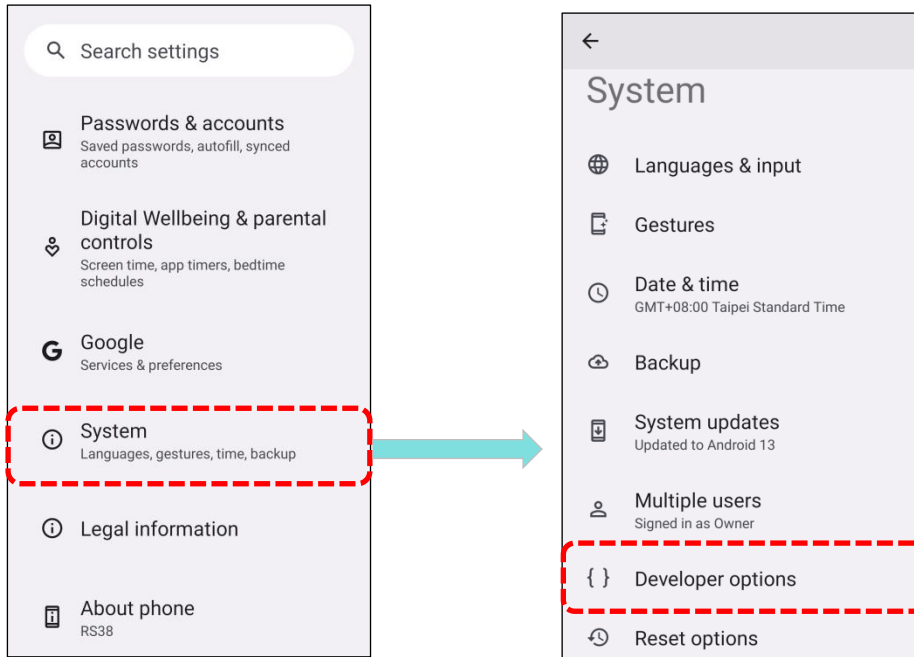

Once you become a developer, you can locate **Developer options**  within the **System**  page.



CHECK MEMORY USAGE

Go to [App Drawer](#) | **Settings**  | **System**  | **Developer options**  | **Memory** to enter memory manager screen.

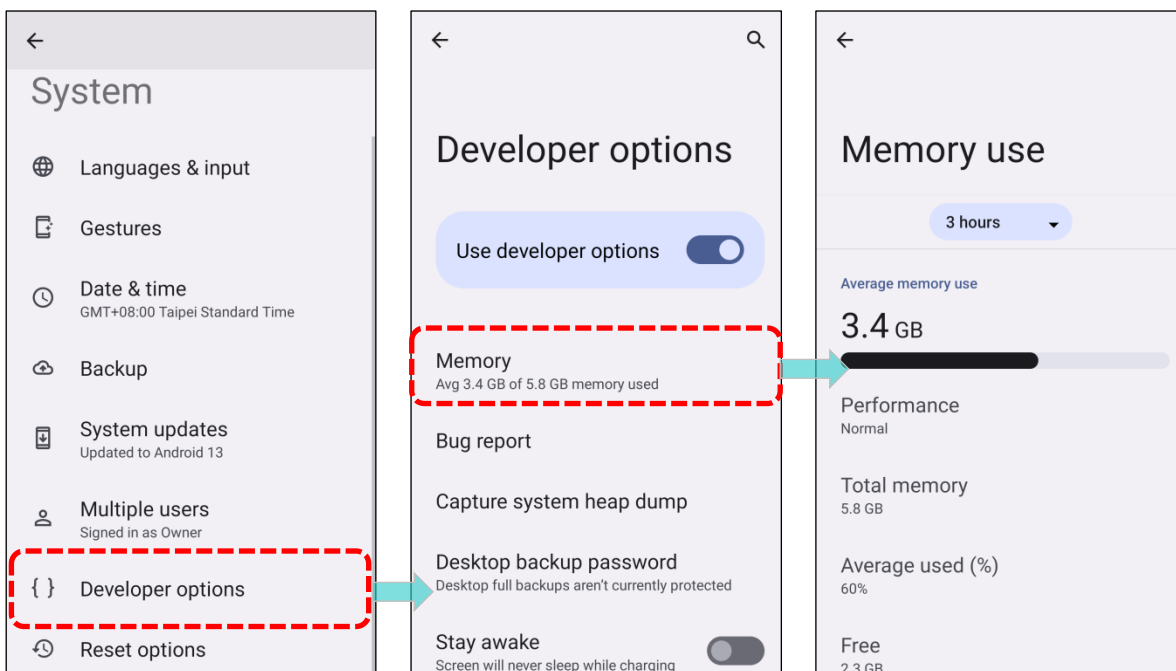

The main screen not only provides information about used and free memory space in RAM but also offers insights into how your usage patterns have affected the overall performance of the device. To analyze the memory usage by the system and apps over an extended period, simply tap the dropdown list to select a different time span.

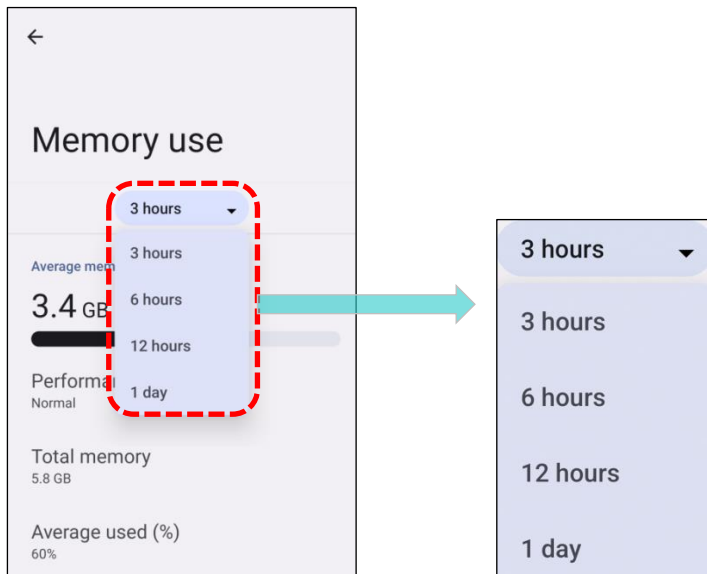

To examine how each individual app utilizes memory space:

- 1) Tap **"Memory used by apps"** for a detailed breakdown.
- 2) Tap an app name to view its memory usage, helping you understand how much RAM a newly installed app may consume.

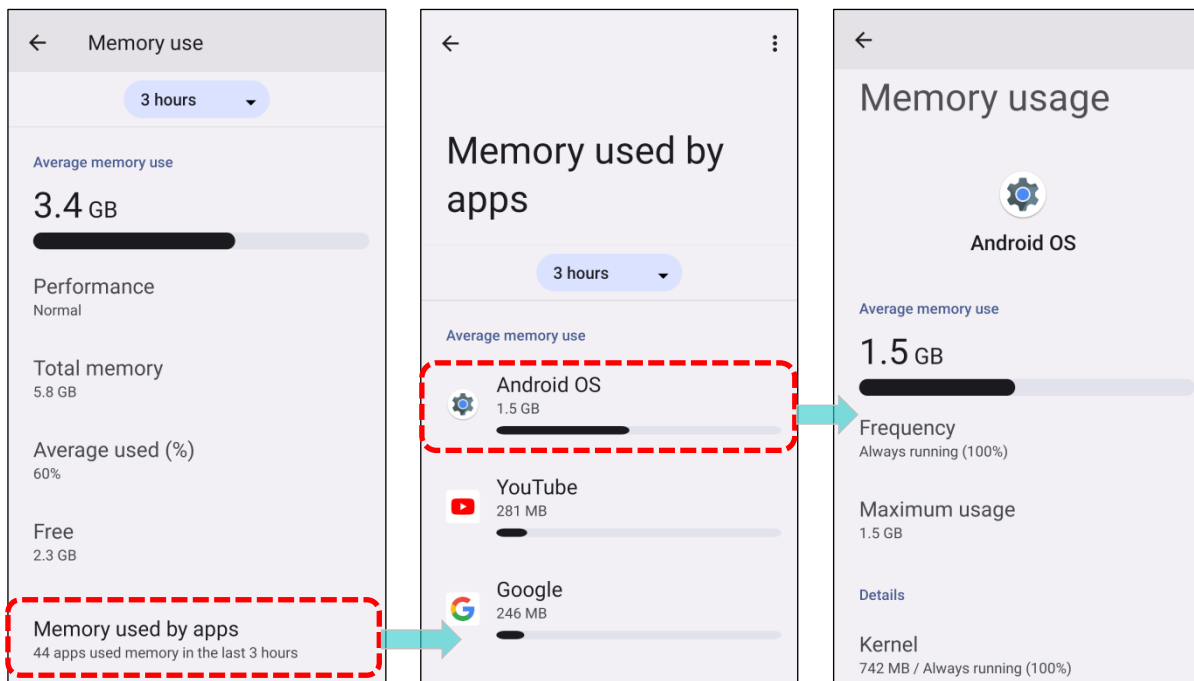

2.2.2. MANAGE STORAGE SPACE

The SD card can serve as an extension of your Android device's internal storage, supplementing the built-in 128 GB of flash memory to store the OS, applications and files, rather than merely serving as a portable storage option.

Go to [App Drawer](#) | **Settings**  | **Storage**  to check usage of the internal and external storage spaces.

By default, videos, photos and downloaded files are saved to the device's internal storage. If you have previously inserted and mounted an SD card as [portable storage](#), you can transfer or save photos and other media content to the SD card. When the SD card is set as [internal storage](#), photos, it allows for movement of photos, files, and certain apps to the SD card.

- SD Card as **Portable Storage** in Storage Settings Page

The SD card is used for transferring photos and other media content media between devices.

- SD card as **Internal Storage** in Storage Settings page

The SD card exclusively stores apps and photos on this device. It requires formatting, rendering it incompatible with other devices.

SET UP SD CARD AS PORTABLE STORAGE

Using SD card as a portable device allows you to treat it as a USB disk, facilitating easy file transfer between your Android device and computer. This is convenient for offloading large files and freeing up storage space.

When this device is connected to a PC, the disk content is readable from the PC client:

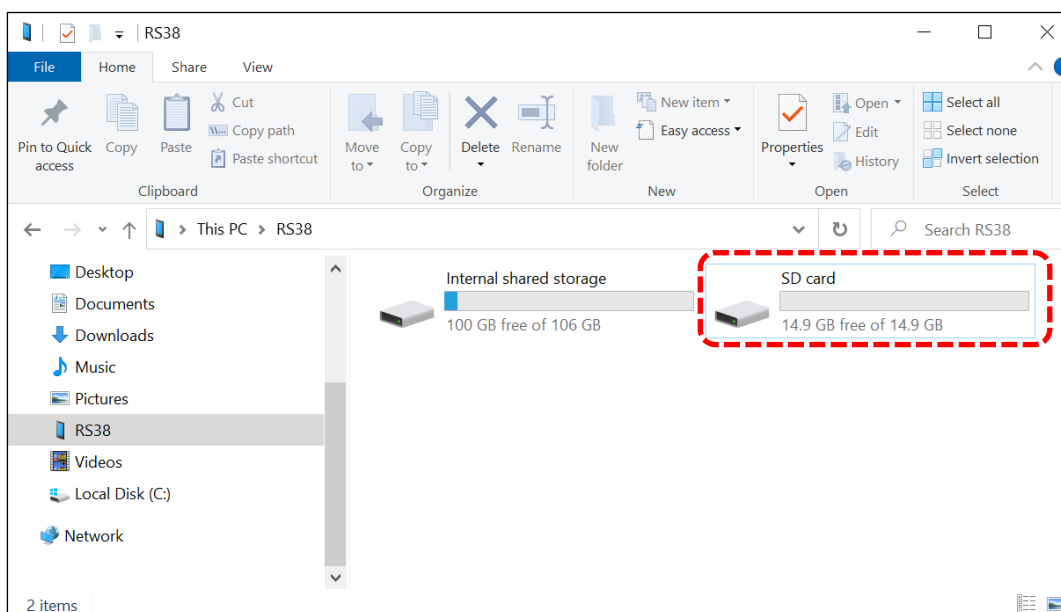

On the **Storage** screen, this disk can be managed separately.

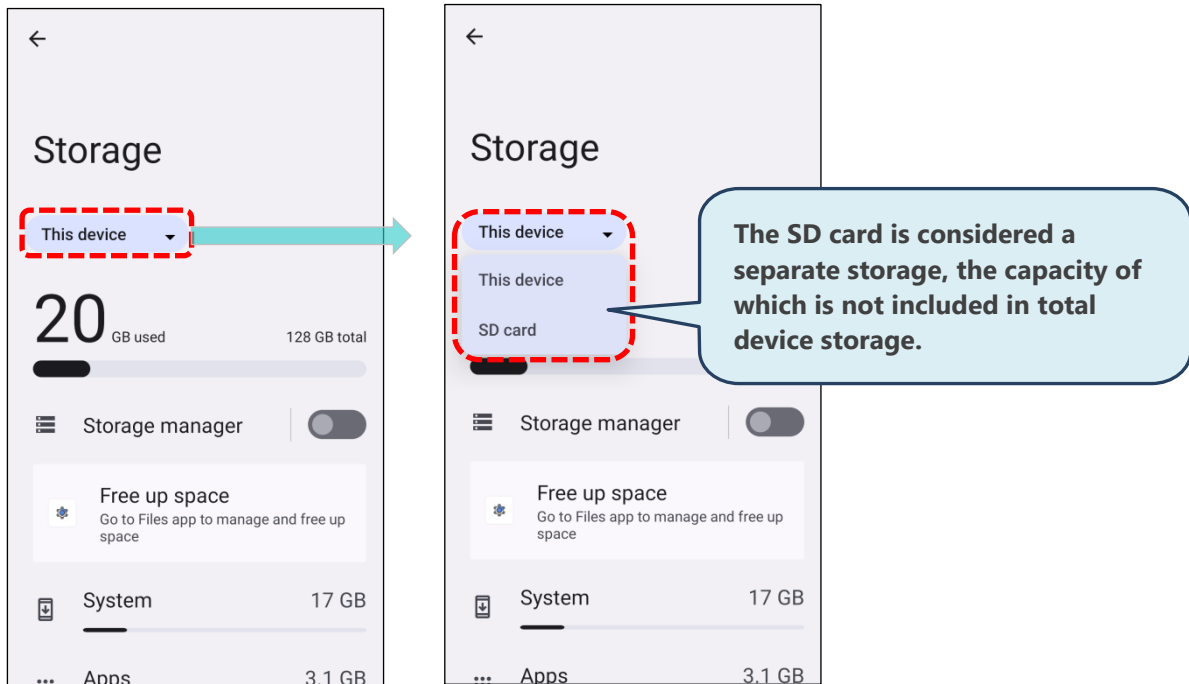

To start:

- 1) Insert the SD card. A notification icon  indicating that an SD card is detected will be shown in the status bar. Swipe down from the status bar and tap to set up.
- 2) A page will appear prompting you to **format the SD card for portable storage**. Tap **"Format"** and then tap on **"Done"** to complete the setting.

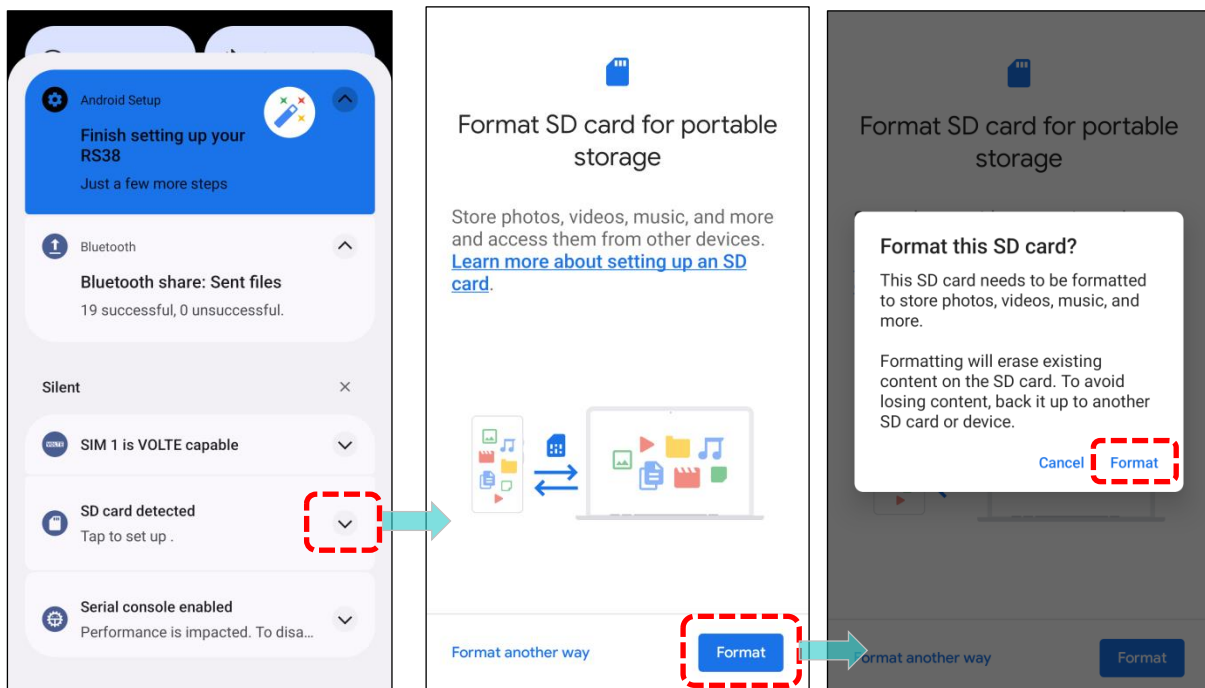

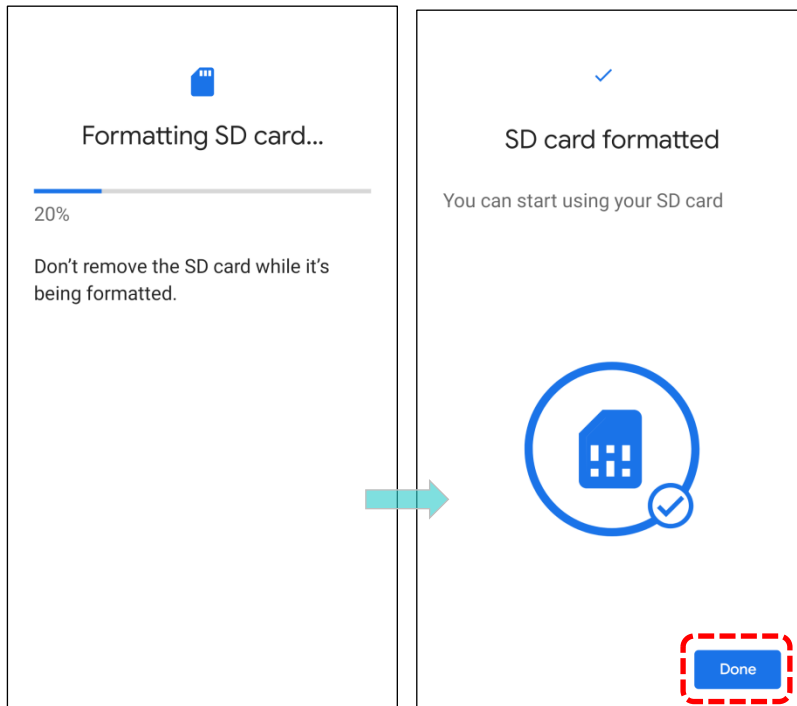

- 3) Once the SD card is formatted, swipe down from the status bar to reveal Notification Drawer. You will find a notification indicating that the SD card is ready for use. Tap "**EXPLORE**" to access the content. Alternatively, you can check the SD card by tapping "**Files**" on the **Storage** page.

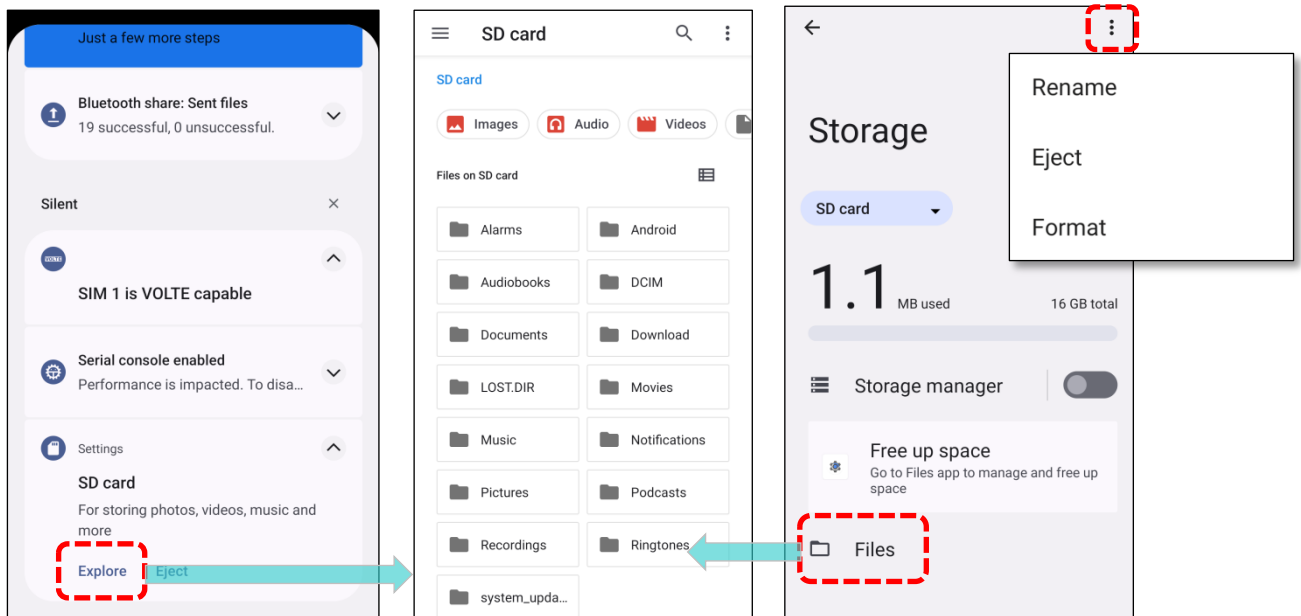

- 4) Tap on More  on the storage page to **rename** the SD card storage, to **eject** the SD card,. Or to **reformat** your SD card from portable to internal.

TRANSFER PHOTOS & MEDIA CONTENT BETWEEN DEVICE & PC

To transfer photos and media between this device and a PC when the mounted SD card is set as portable storage, please follow these steps:

- 1) Connect your mobile computer to the PC using a USB Type-C cable, and the “**USB Preferences**” page will appear. Tap to select “**File Transfer**”.

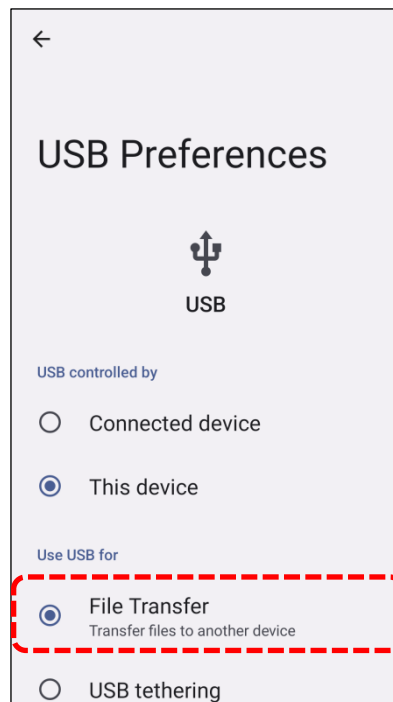

- 2) You will find the disk content is readable from PC client. Please make sure the USB cable is properly connected while transferring files over USB connection.

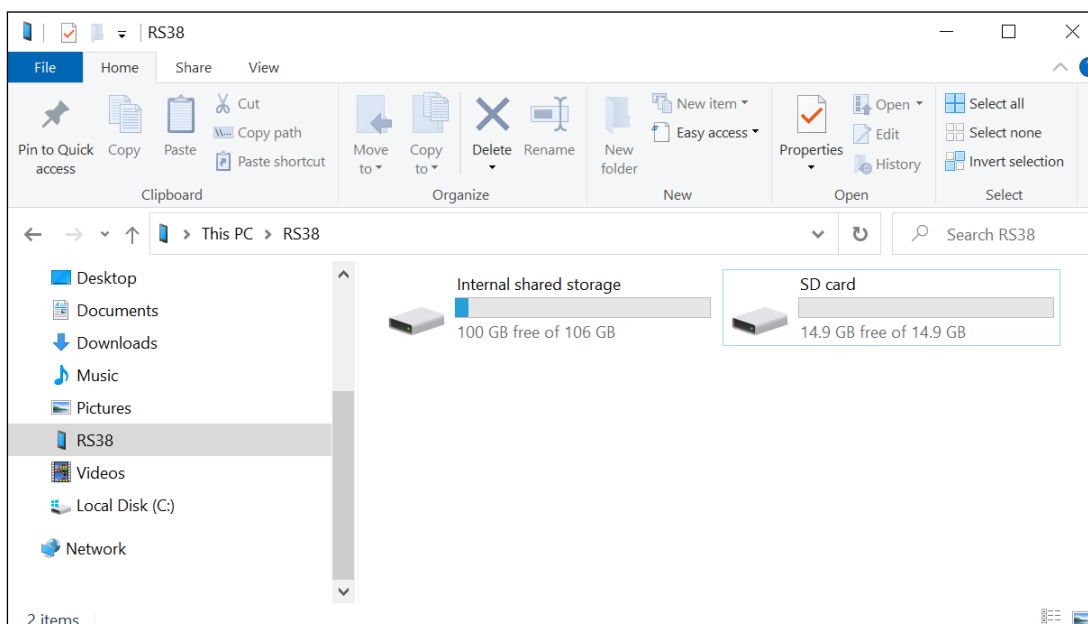

CONVERT THE SD CARD TO INTERNAL STORAGE

You can convert the SD Card from portable storage to internal storage at anytime. Before proceeding, ensure you make a backup of the files on this disk if you wish to retain them.

- 1) On the **Storage** screen, tap the SD card to enter the SD card content screen. Tap **More**  and then select **"Format"**.

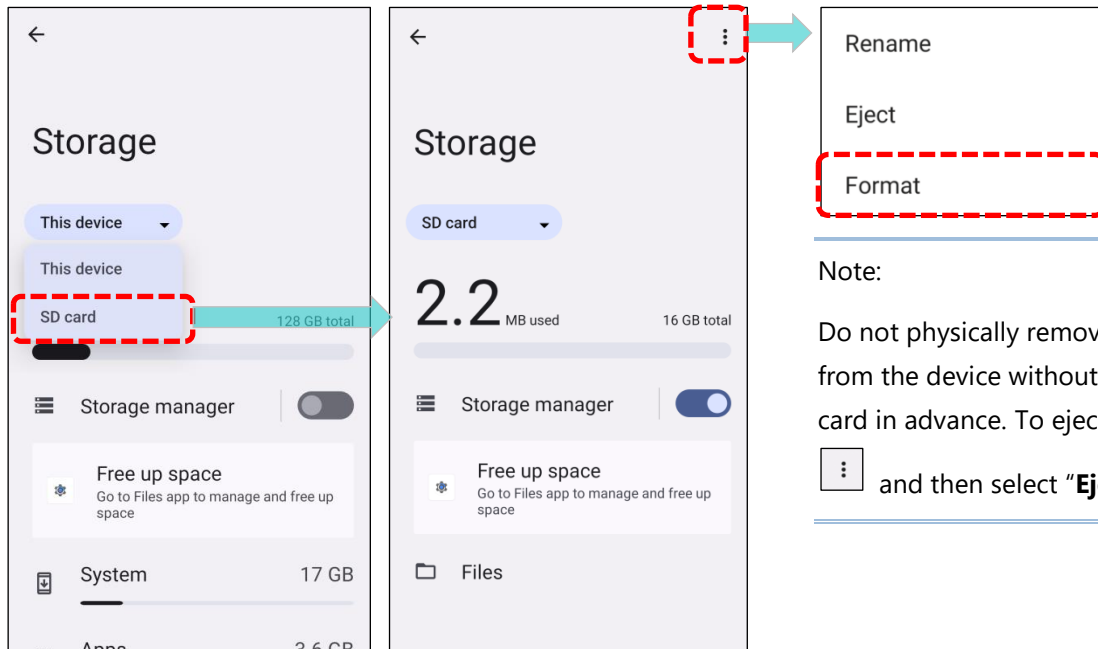

Note:

Do not physically remove the SD card from the device without ejecting this card in advance. To eject, tap **"More"**

 and then select **"Eject"**.

- 2) By selecting **"Format"**, a page will appear prompting you to format the SD card for portable or internal storage. Tap on **"Format another way"** to **convert SD card for internal storage**.

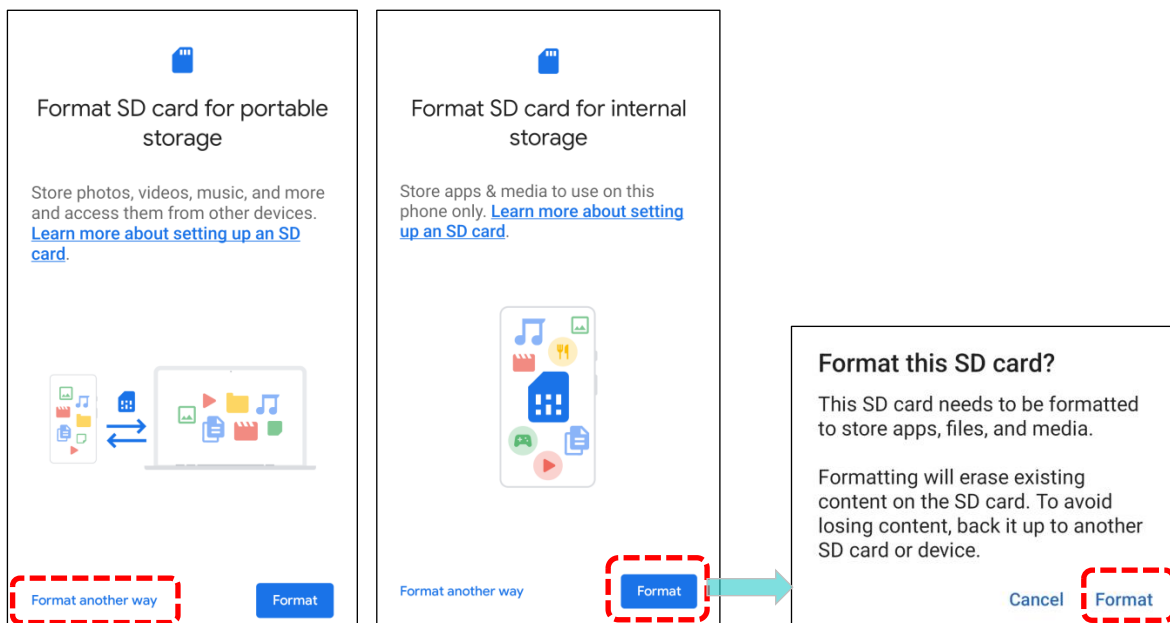

- 3) When the **"Format this SD card?"** popup appears, tap **"FORMAT"** to proceed. Once the formatting is complete, you will be guided to the storage page.

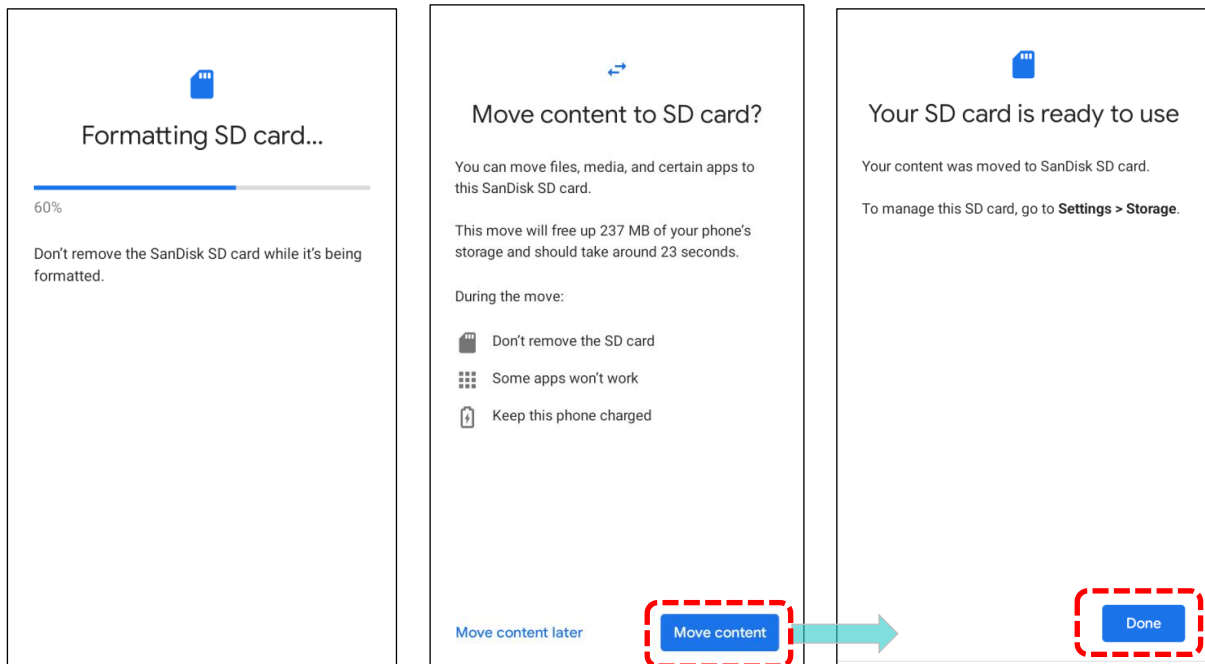

- 4) If you select **"Move content later"** during formatting and later wish to transfer multimedia files to the new SD card, navigate to the storage page, tap More  then choose **"Migrate data"**.

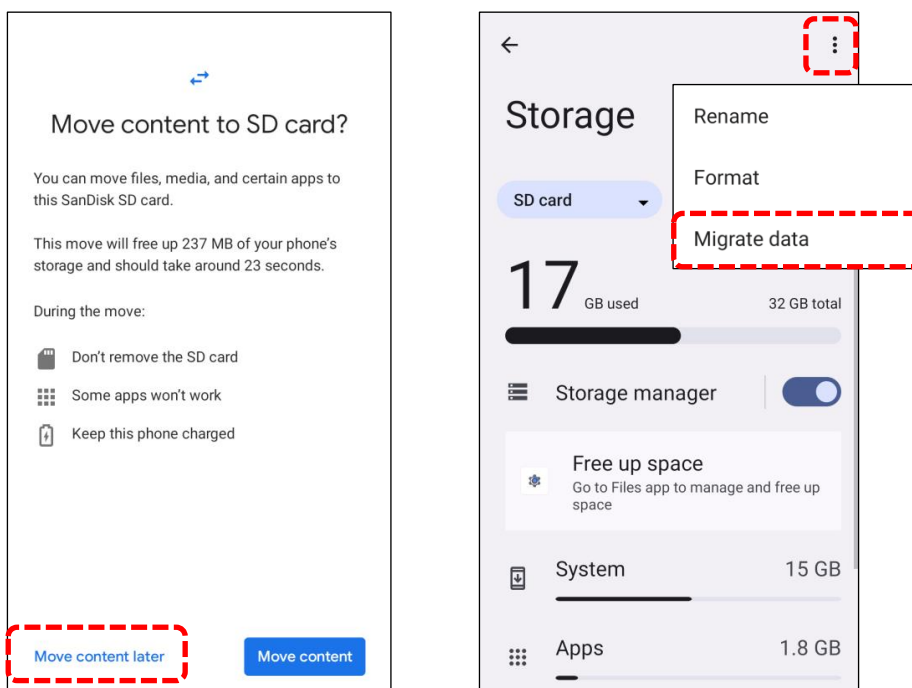

SET UP SD CARD AS INTERNAL STORAGE

Using SD card as internal storage allows you to extend your existing device storage and to store huge applications. This SD card will be reformatted and encrypted with a file format that is not readable by another device. Therefore, it is essential that you back up important files on this SD card in advance. Please note that if you eject this SD card, the applications and media files stored on it will not be available until you reinsert the card.

When this device is connected with PC, the disk content is not readable from PC client:

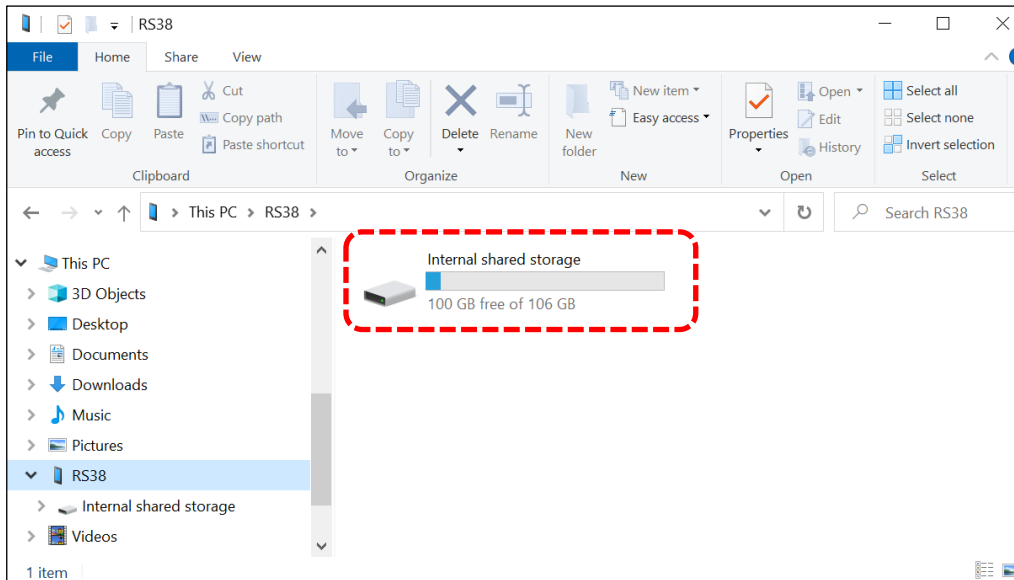

On the **Storage** screen, the capacity of the SD card is combined with the total device storage. Please note that in this setting, you won't have control over which files are stored on the SD card.

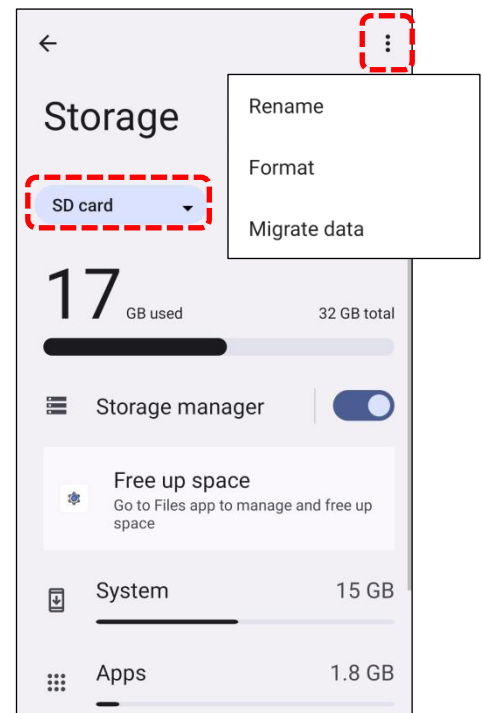

Warning:

Before physically removing the SD card, ensure you've formatted it as portable. To eject, tap "**More**"  and then select "**Eject**".

To start:

- 1) Insert the SD card, then tap on the notification to set up the detected SD card.

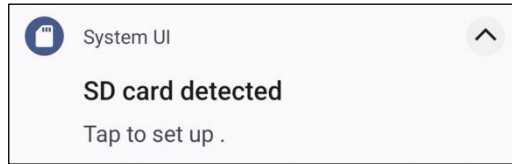

- 2) Tap on **"Format another way"** to choose **"Format SD card for internal storage"**.
- 3) To avoid losing content, back it up to another SD card or device then tap **"Format"**.

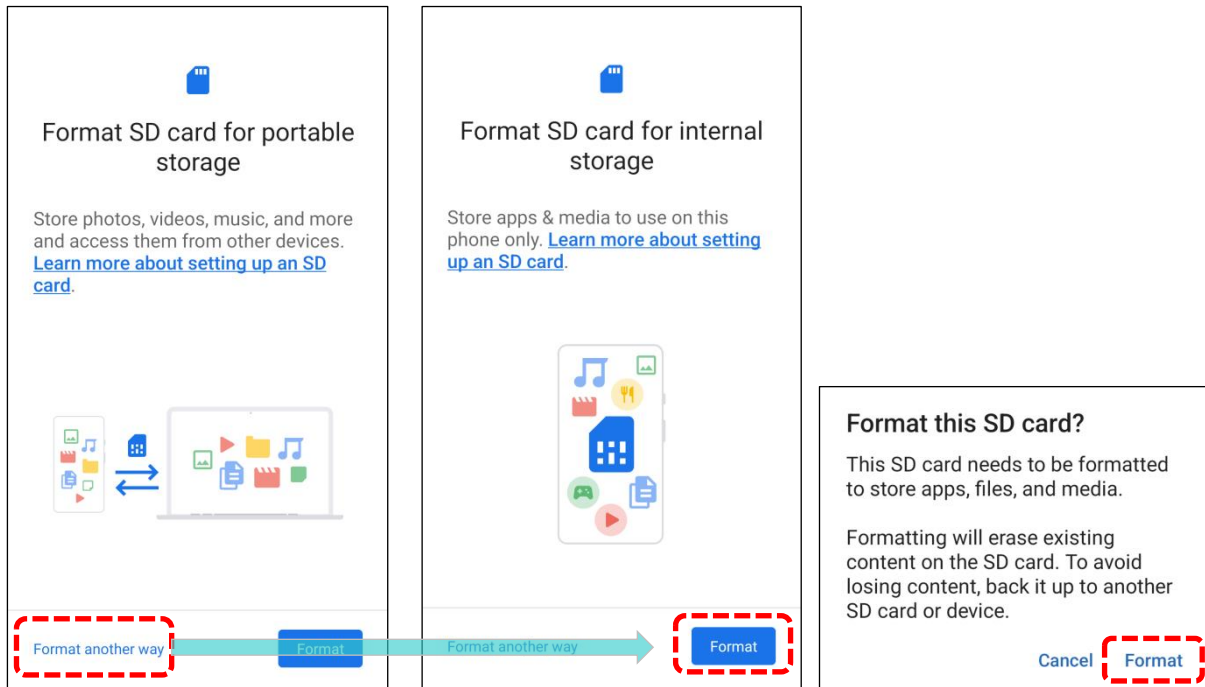

- 4) When the setting is completed, tap **"DONE"**.

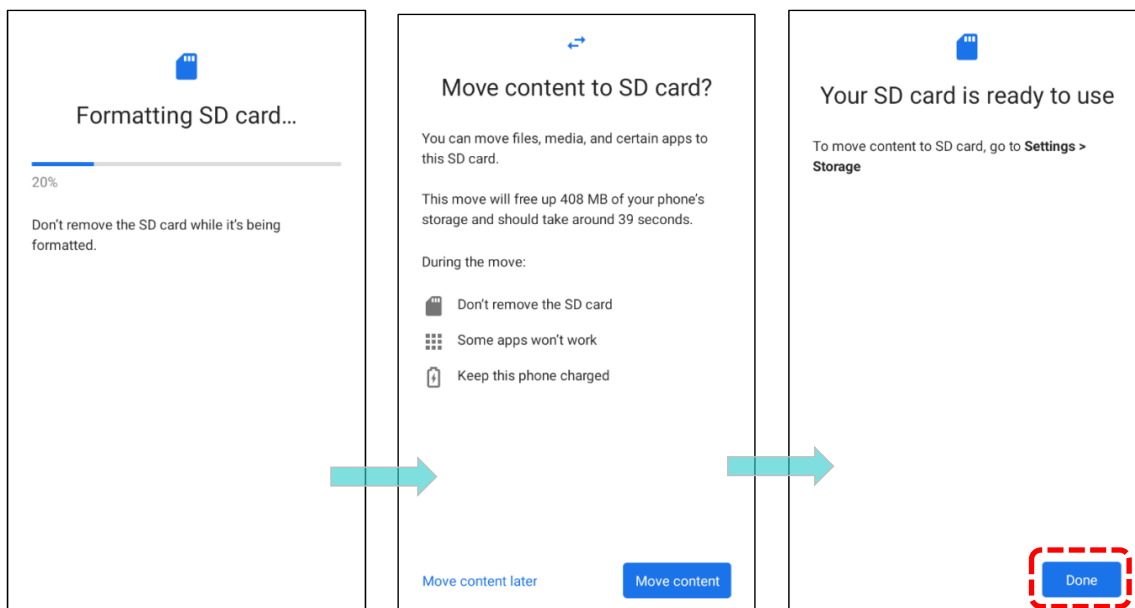

Note:

It is recommended that you select “**Move content**” at Step 4 to have the device immediately start making use of SD card space. If you select “Move later”, the device will continue to consider device’s original storage the primary location to save files.

CONVERT THE SD CARD TO PORTABLE STORAGE

You can always convert the SD Card from internal storage to portable storage. Before you start, make a backup of the files on this disk if you would like to keep them.

- 1) Enter the SD card content screen from **Storage** screen by tapping on “**SD card**”.
- 2) Tap **More**  and then tap “**Format**”.

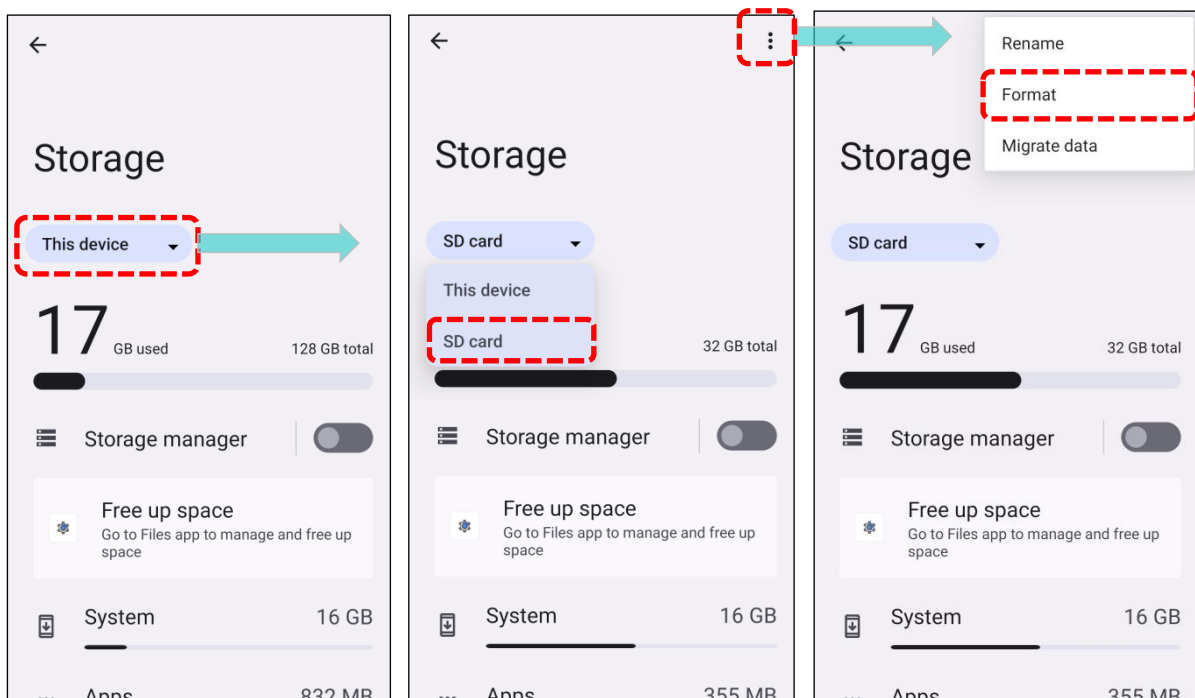

- 3) On **"Format SD card for portable storage"** page, tap on **"Format card"** to have this SD card re-formatted into a file type accessible by other devices.
- 4) When the formatting is completed, tap **"DONE"**.

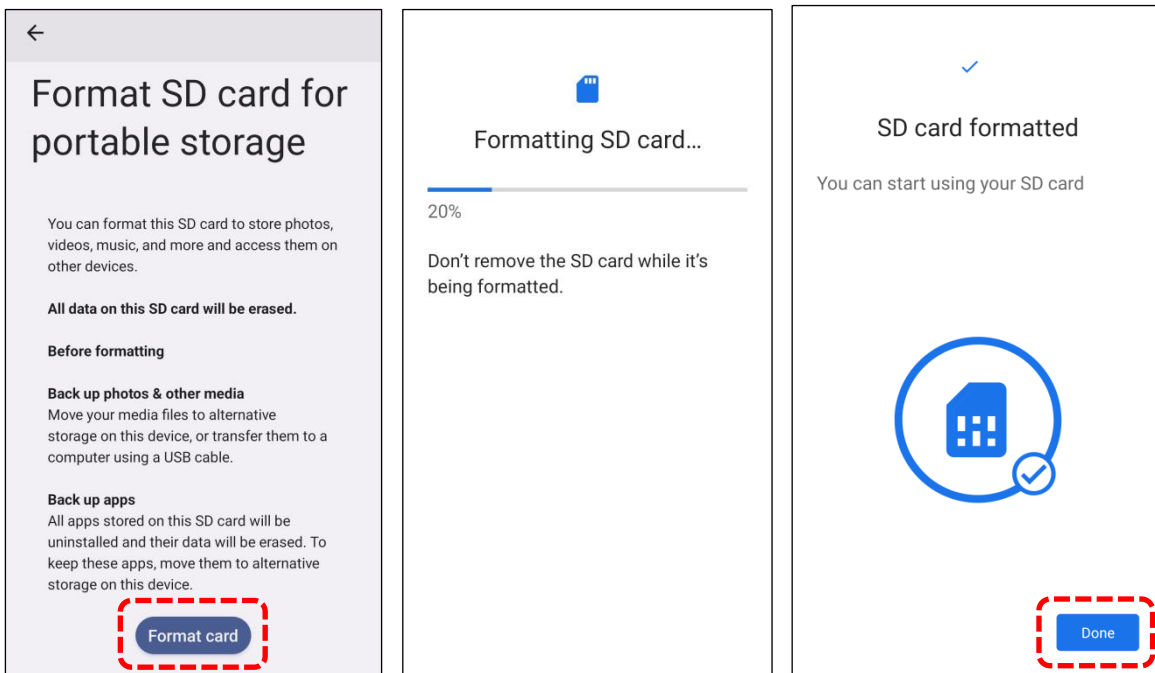

Note:

Please do back up important files on this SD card before proceeding formatting.

2.3. TOUCH SCREEN

The mobile computer is equipped with a 6.0-inch display that is outdoor viewable and optically bonded to a Corning® Gorilla® Victus Touch Panel. This display features a high-definition resolution of 1080x2160 HD.

The LED backlight of the screen is designed to enhance readability in dim environments and can be adjusted both manually and automatically.

Warning: Avoid using pointed or sharp objects on the screen surface.

2.3.1. SCREEN BRIGHTNESS

To adjust touch screen brightness **manually**:

- 1) Go to [App Drawer \(All Apps\)](#) | **Settings**  | **Display**  | **Brightness level**.
- 2) Adjust the slider to the right to increase brightness or to the left to reduce it. Alternatively, make quick adjustments using the brightness slider in the **Quick Settings Menu**.

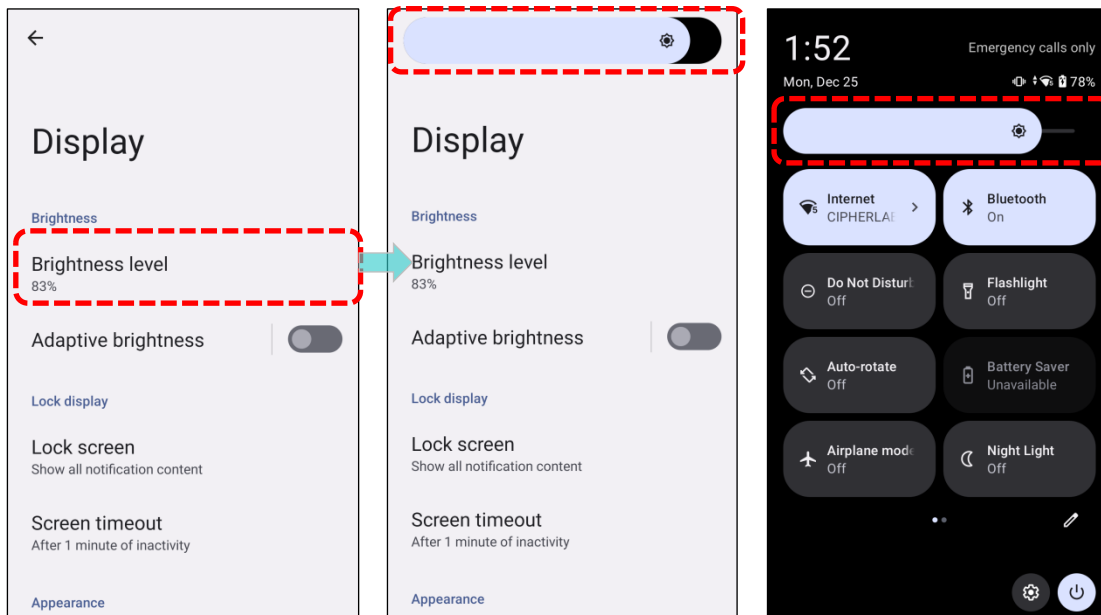

To **automatically** adjust screen brightness:

Activate **Adaptive Brightness** for automatic backlight adjustment using the built-in sensor.

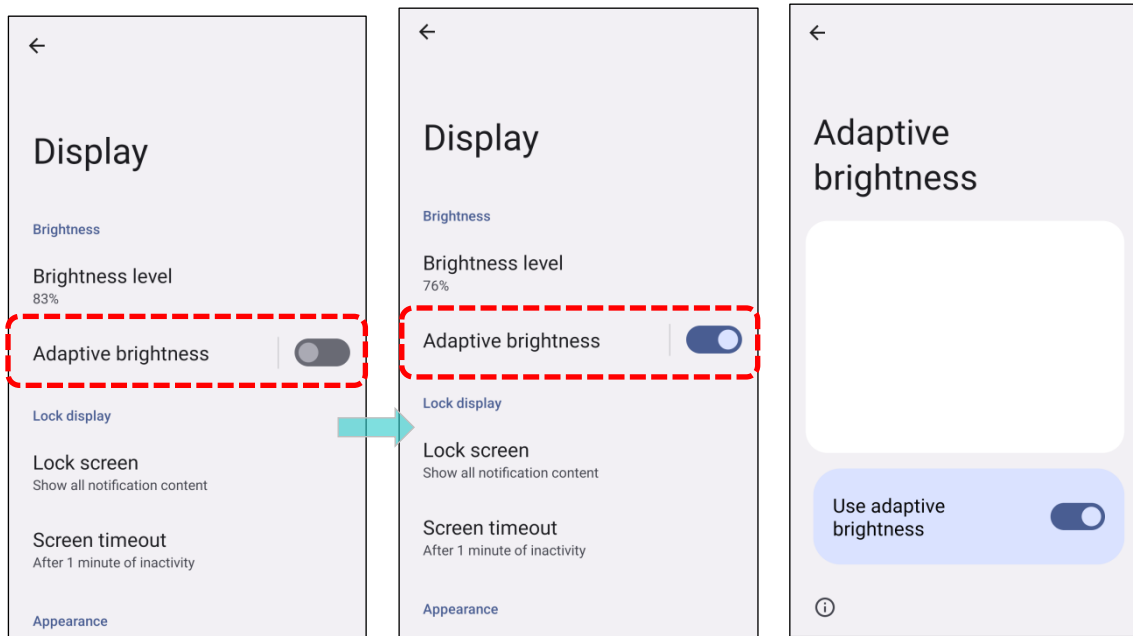



Note:

- (1) To save battery power, dim the screen brightness while working in well-lit areas, or set a shorter [screen timeout](#) for the screen backlight to go off.
- (2) With Adaptive brightness enabled, your screen brightness will automatically adjust to your environment and activities. You can move the slider manually to help adaptive brightness learn your preferences.

2.3.2. SCREEN ROTATION

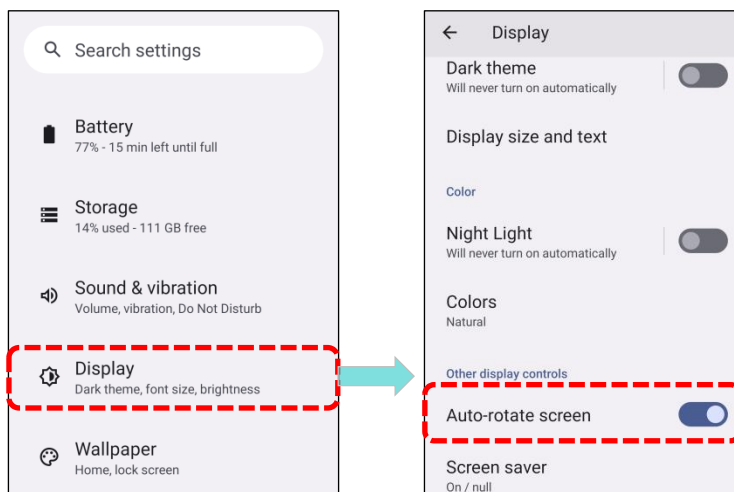

By default, the device automatically rotates the screen to when you turn the device sideways.

To switch this function on or off, go to [App Drawer \(All Apps\)](#) | **Settings**  | **Display** , and **swipe** to the bottom of the page to toggle **Auto-rotate screen** on or off.

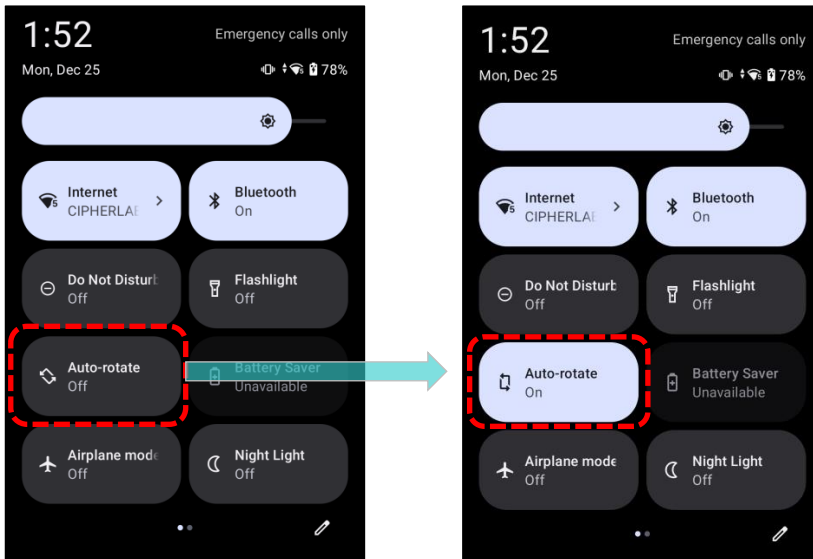

Alternatively, swipe down from the top of the screen to open **the Quick Settings Menu**, then tap the **Auto rotate** icon  to enable screen rotation.



| Icon | Description |
|---|----------------------------------|
|  | Auto rotate mode is OFF . |
|  | Auto rotate mode is ON . |

You can enter **“Auto-rotate screen”** page to enable or disable screen rotation by long pressing the **Auto rotate** icon on **Quick Settings Menu**.

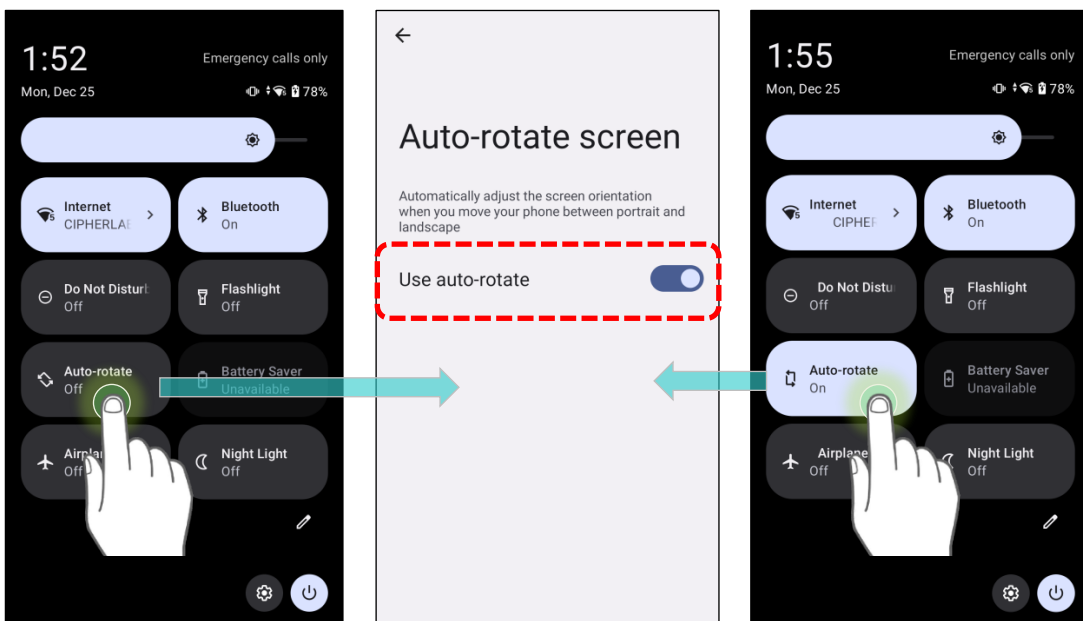

HOME SCREEN ROTATION

To enable Home screen rotation, please make sure **Auto Rotation** is enable.

- 1) Press any empty spot on **Home screen**.
- 2) Tap "**Home Settings**" and enable "**Allow Home screen rotation**".

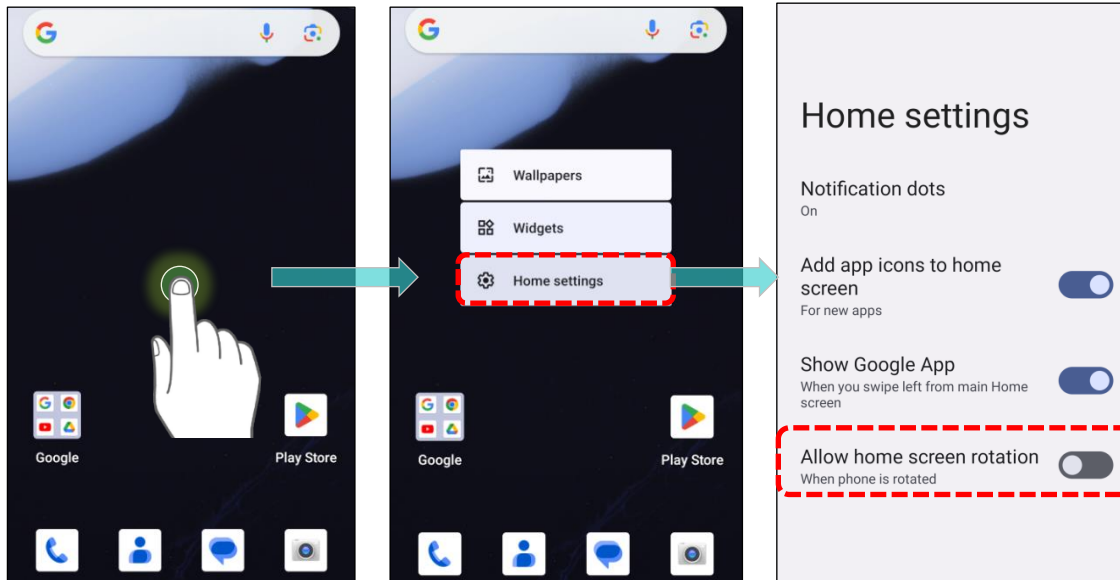

REMOVE AUTO ROTATION FROM QUICK SETTING MENU

To minimize accidental activation of the auto-rotation function, remove the Auto rotate switch icon from the Quick Settings Menu.

- 1) Swipe down from the top of the screen to open **Quick Settings Menu** and click on **Edit**  to enter **Edit** page.

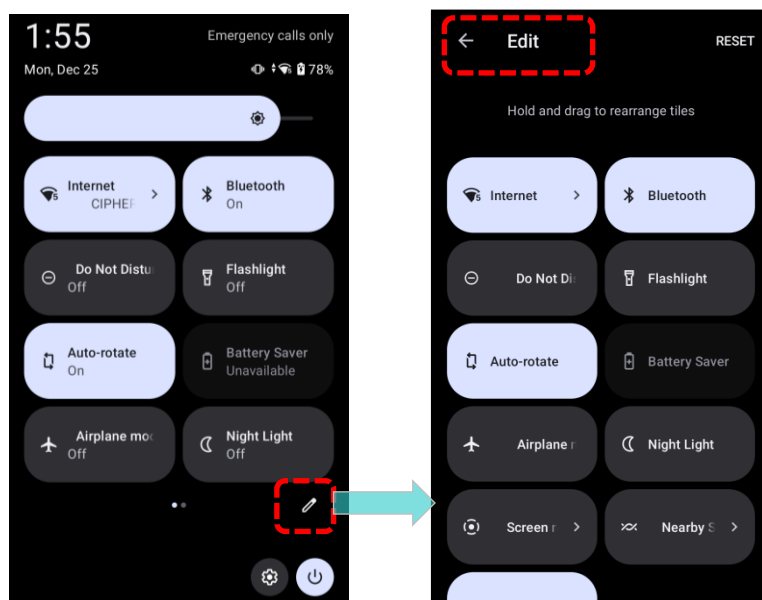

- 2) Tap on and hold the **Auto-rotate** icon, and drag it to the **“Drag here to remove”** area and then release it.

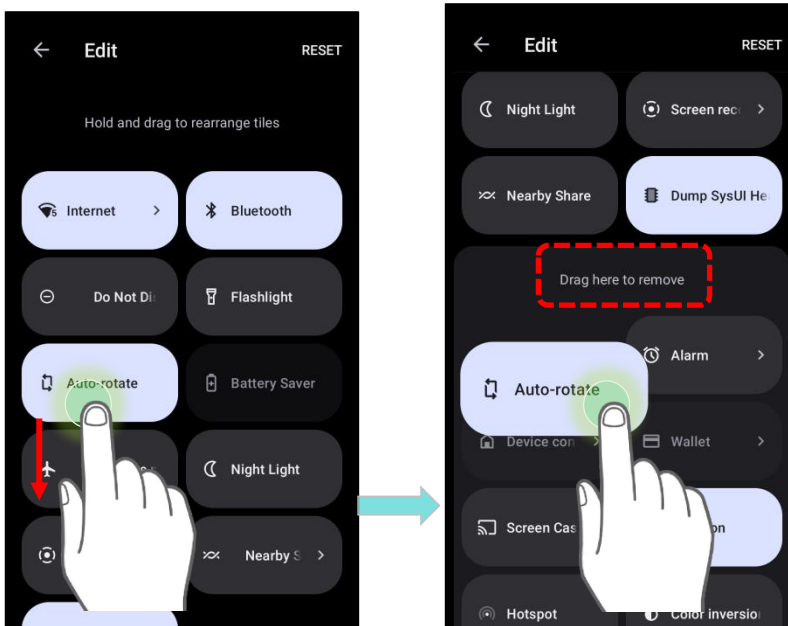

- 3) Return to the **“Quick Settings Menu”**, the **“Auto rotate”** switch icon is now hidden.

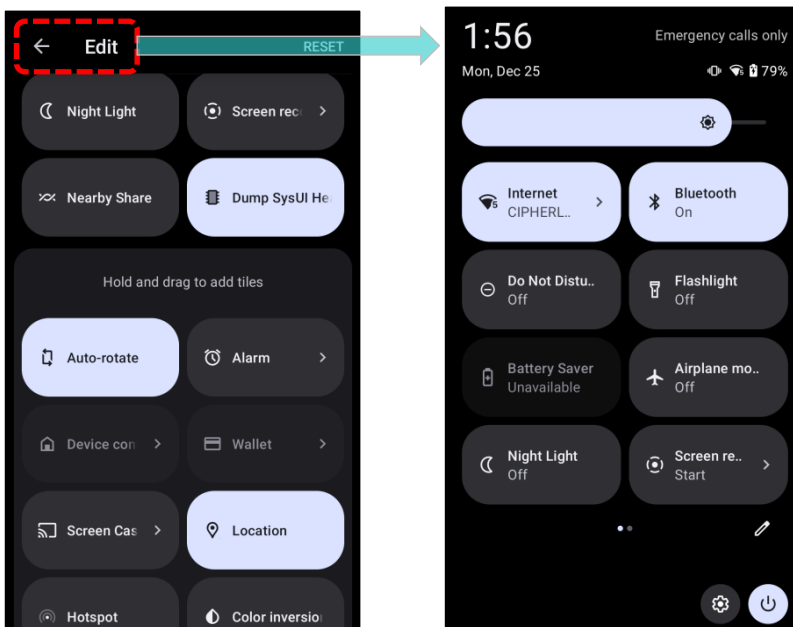



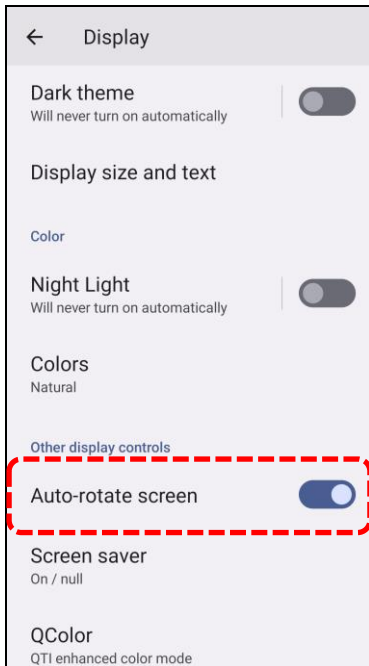

REMOVE AUTO ROTATION FROM THE DISPLAY SETTING PAGE

On the Display setting page, “**Auto-rotate screen**” is listed under “**Other display controls**”.



To remove “**Auto-rotate screen**” on the **Display** setting page, please go to [App Drawer \(All Apps\)](#) |

Settings  | **Accessibility**  | **System controls**, and toggle off the **Auto-rotate screen**. By doing so, the auto-rotation option will be hidden in **Settings**  | **Display** .

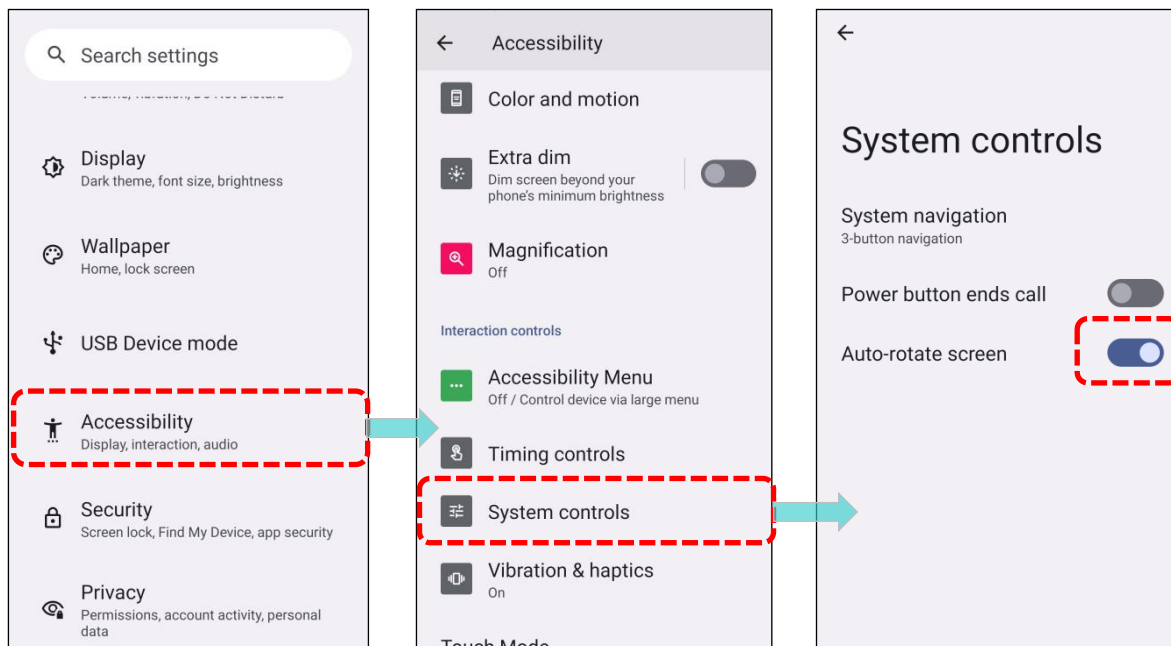

Now the option “**Auto-rotate screen**” is hidden on the “Display” page.

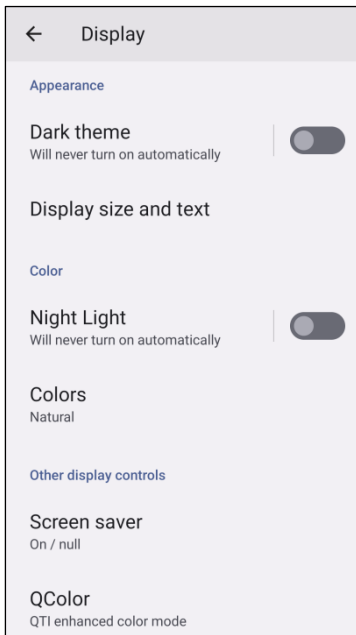



Note:

- (1) Auto-rotation is not supported for certain applications.
 - (2) Without enabling “[Allow Home Screen Rotation](#)”, auto-rotation is inapplicable in Home Screen and [App Drawer](#) screen.
-

2.3.3. SCREEN TIMEOUT SETTINGS

Screen Timeout automatically turns off your device's display after a set period of inactivity for power-saving purposes.

To set **Screen Timeout** duration, go to [App Drawer \(All Apps\)](#) | **Settings**  | **Display**  | **Screen timeout**, and choose the screen timeout duration.

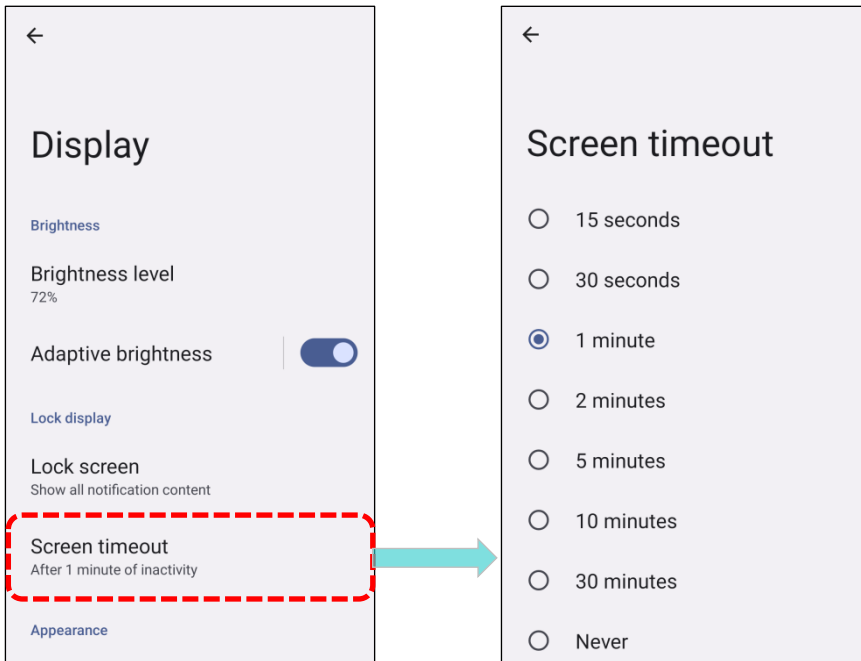

To prevent the screen from turning off while looking at it, turn on **Screen attention**.

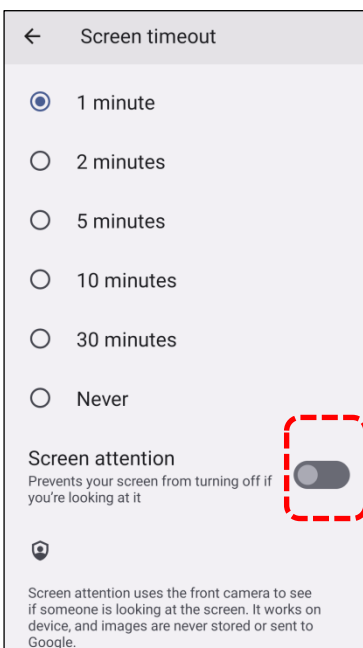

2.3.4. DISPLAY SIZE AND TEXT

Adjust the **“Display size and text”** to customize the visual and text size on your device for optimal readability and comfort.

- 1) Go to [App Drawer \(All Apps\)](#) | **Settings**  | **Display**  | **Display size and text**.
- 2) Tap the plus icon **+** or the minus icon **-** to adjust **Font size** and **Display size**. Preview your changes on the top of the page to find the preferences that suit you.
- 3) You can also toggle on or off **Bold text** and **High contrast text** according to your preferences.

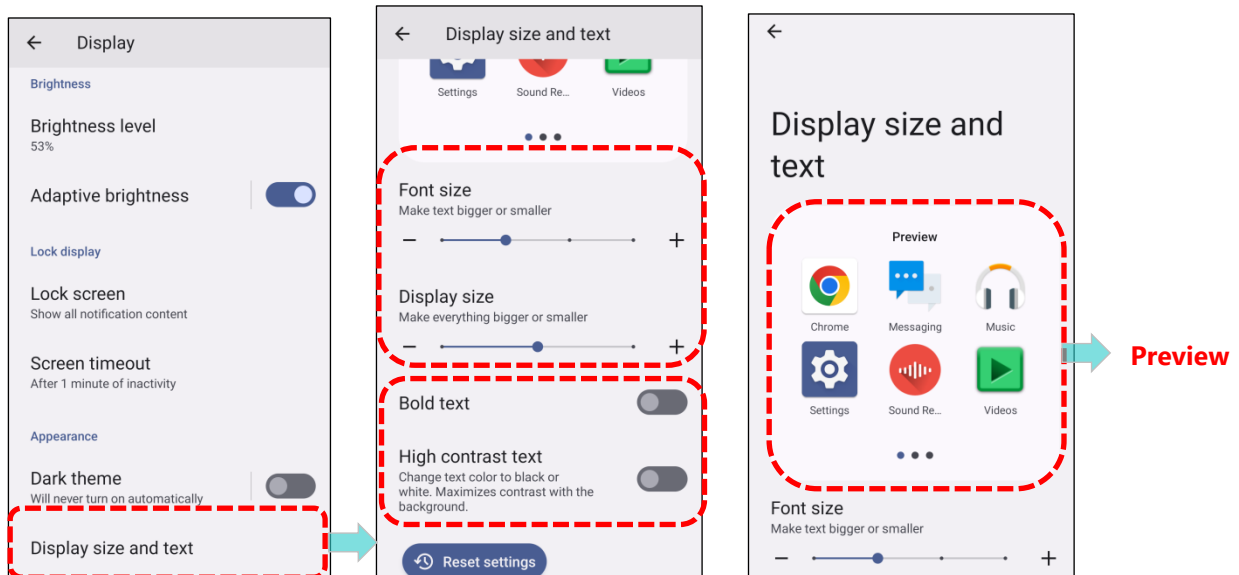

To reset the Font size and Display size, tap on **Reset settings**.

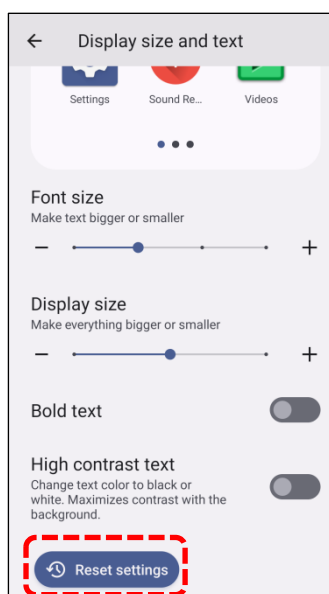

2.4. NOTIFICATIONS

2.4.1. STATUS LED

This section provides information about [LED 1](#) and [LED 2](#). LED 1 indicates charging status, while LED 2 handles reader and system notifications.

| LED 1 for Charging Indication | | |
|-------------------------------|-----------------|--|
| | Status | Description |
| Charging | Breathing Red | Charging the mobile computer (0% to 90%) |
| | Breathing Green | Charging the mobile computer (91% to 99%) |
| | Solid Green | Charging complete (100%) |
| | Blinking Red | Charging error (e.g., charging temperature lower than 0°C or exceed 40°C) |

| LED 2 for Reader & System Notification | | |
|--|-------------------|------------------|
| | Status | Description |
| Barcode decode | Green, flash once | Good read |
| System notification | White, blinking | New notification |

Note: To enable LED2 (Reader & System Notification), ensure to enable the notification settings in the **"ReaderConfig"** app. For details, please refer to [ReaderConfig User Guide](#).

2.4.2. AUDIO

The device is equipped with a built-in speaker for system events and audio playback, allowing for programmed status feedback. In noisy environments, a Bluetooth headset can be used for enhanced clarity. The mobile computer also accommodates headsets via USB Type-C audio adapters, supporting both analog and digital earphones.

Supported audio file formats include WAV, MP3, AAC, AAC+, Enhanced AAC+, AU (including ADPCM), Midi, XMF, AMR (NB and WB), Enhanced low delay AAC, FLAC, Vorbis, and PCM.



Adjust the system volume easily using the side-mounted volume buttons.

2.4.3. SOUND AND VIBRATION





The mobile computer is equipped with a programmable integrated vibrator, offering tactile feedback for assistance in noisy environments.

Additionally, you have the option to set the device to vibrate only, muting all system sounds and replacing them with the vibrator.

QUICK SOUND MENU

On any screen, press the **Volume Up** or **Volume Down** key to access the quick sound menu. Tap on the sound icon , vibration icon , mute icon  to switch between **ringing**, **vibration**, and **mute**.





| Item | Description |
|---|---|
|  | Calls and notifications will ring. |
|  | Calls and notifications will vibrate. |
|  | Calls and notifications will be muted. |
|  | Tap to enter Sound & vibration quick menu/setting page. |
|  | Captions will appear when speech is detected. |

The media volume can be adjusted by pressing the **Volume Up** or **Volume Down** key, or dragging the slider on quick sound menu.

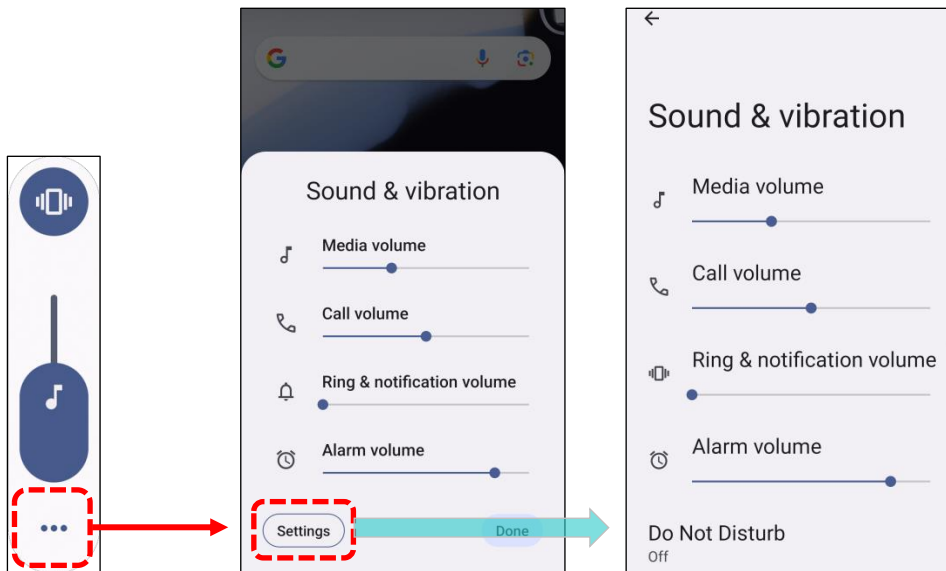
Tapping on the **More** icon  opens the pop-up volume panel, while continue tapping on the **"SETTINGS"** directly enters the **Sound & vibration** setting page."







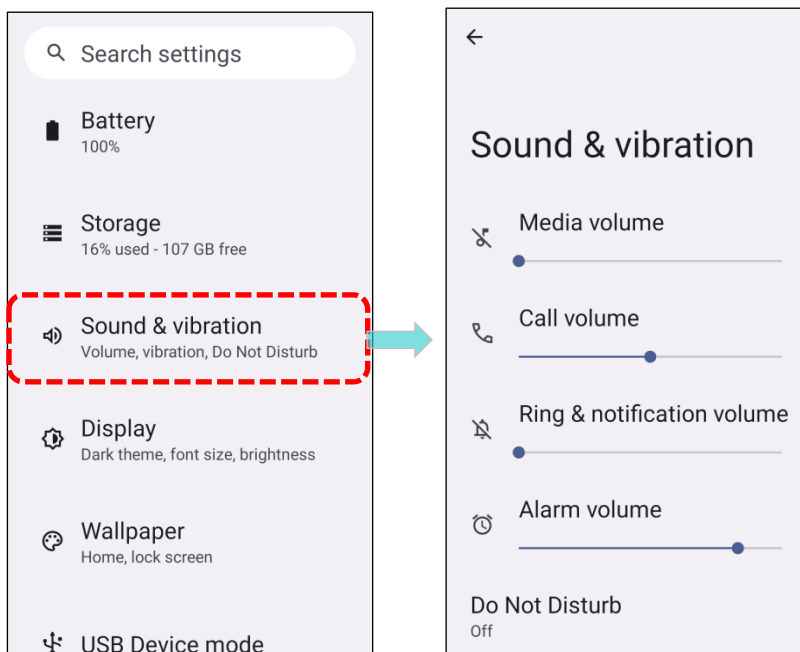

SOUND & VIBRATION SETTINGS



To customize sound and vibration settings, go to [App Drawer \(All Apps\)](#) | **Settings**  | **Sound & vibration** .



On **"Sound & vibration"** settings page, you can:

- Adjust the volume for **Media**  , **Call**  , **Ring & notification**  , and **Alarm**  by dragging the sliders.

The **Media** icon turns from  to  when the **Media** volume is on.

The **Ring & notification** icon turns from  to  when the **Vibration** is off and the **Ring** volume is on, while  indicates that both **Vibration** and **Ring** volume are off.

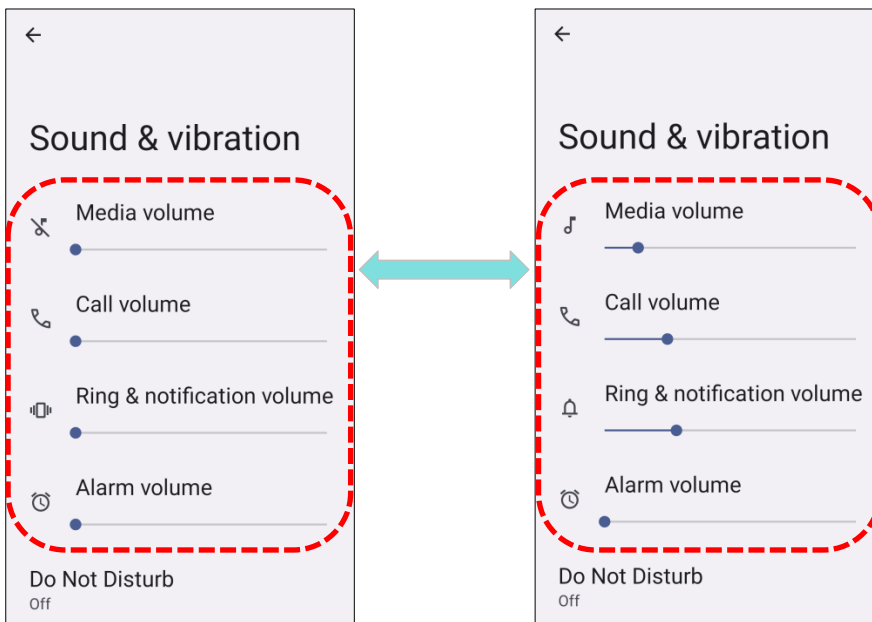

- Enter **“Do Not Disturb”** for its detailed settings.

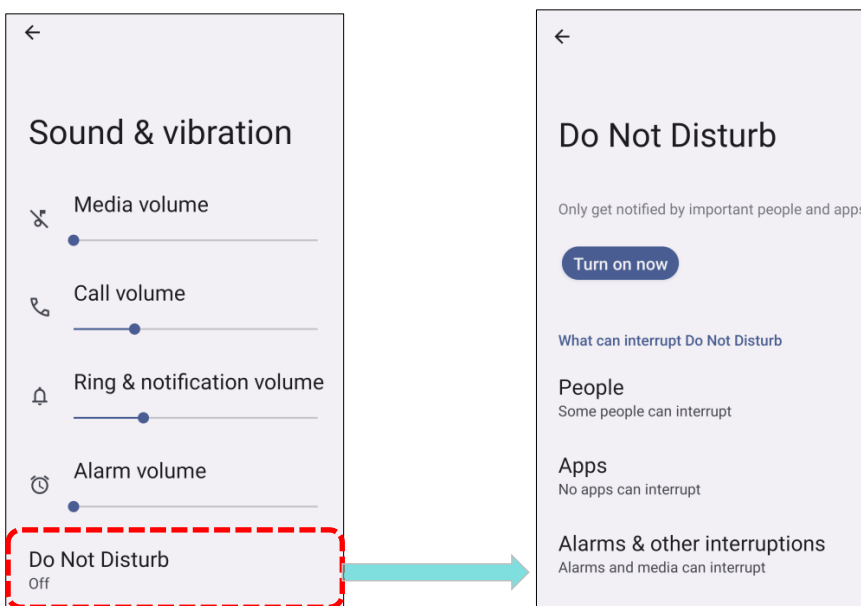

- Enter **“Voice Mode”** or **“Headset Playback”** to adjust volume in a loud environment.

- 1) Swipe to the bottom of the page and tap on **Voice Mode** or **Headset Playback** to enlarge the volume.
- 2) Tap on **"Loudness Mode"** if volume is not sufficient. A caution window will appear upon selection.

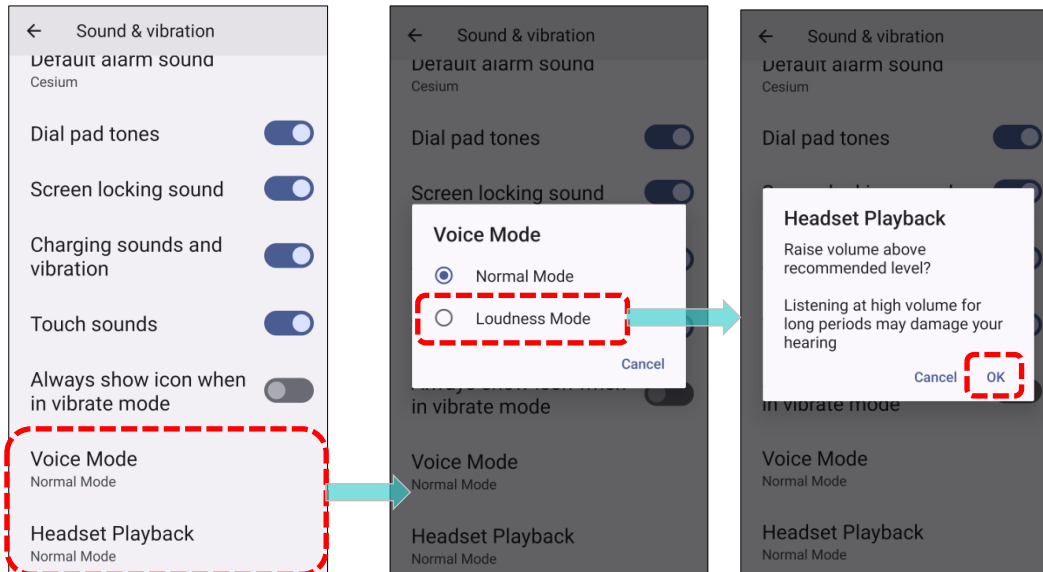

Note: **"Loudness Mode"** can be activated exclusively when a compatible headset is connected. Otherwise, an incompatibility notification will appear, stating, **"The accessory you are using does not support Loudness mode."**

- Select your preferred sound for **"Phone Ringtone"**, **"Default notification sound"** and **"Default alarm sound"**.

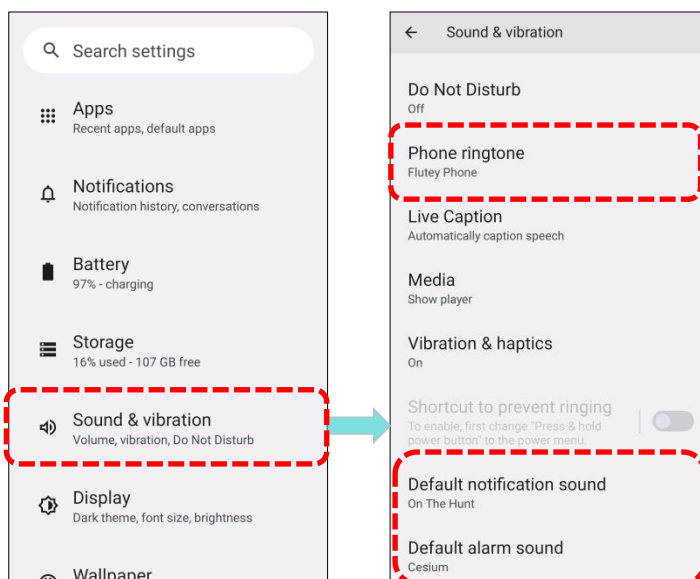

- Swipe down the page to toggle the switches to enable or disable additional settings related to sound and vibration.

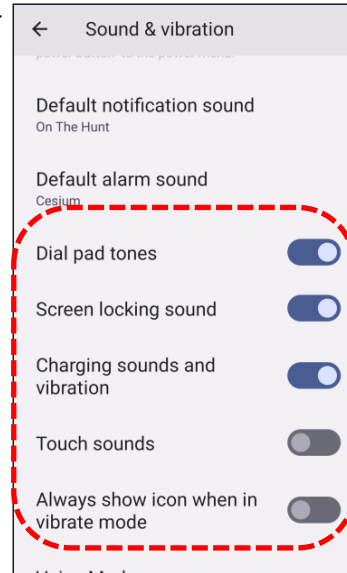

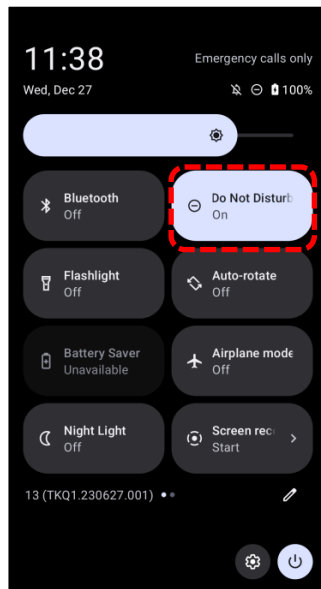
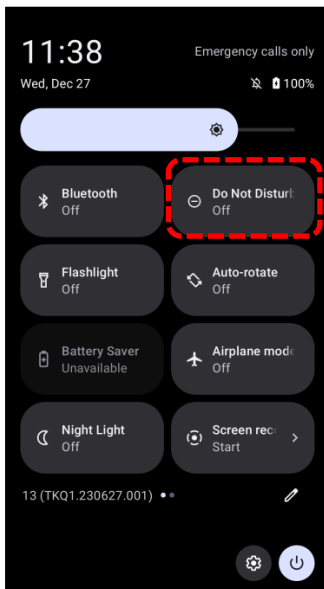

DISABLE UNWANTED NOTIFICATIONS WITH “DO NOT DISTURB”

You can temporarily disable specific notifications (vibration or sound) using “**Do Not Disturb**” in **Quick Settings Menu**. You can also schedule the duration for automatic re-enablement based on your preferences.





- 1) Swipe down from the status bar to open **Quick Settings Menu**, tap on “**Do not disturb**” to enable this feature and make further adjustment.

| Icon | Description |
|---|-------------------------------------|
|  | Do Not Disturb mode is OFF . |
|  | Do Not Disturb mode is ON . |

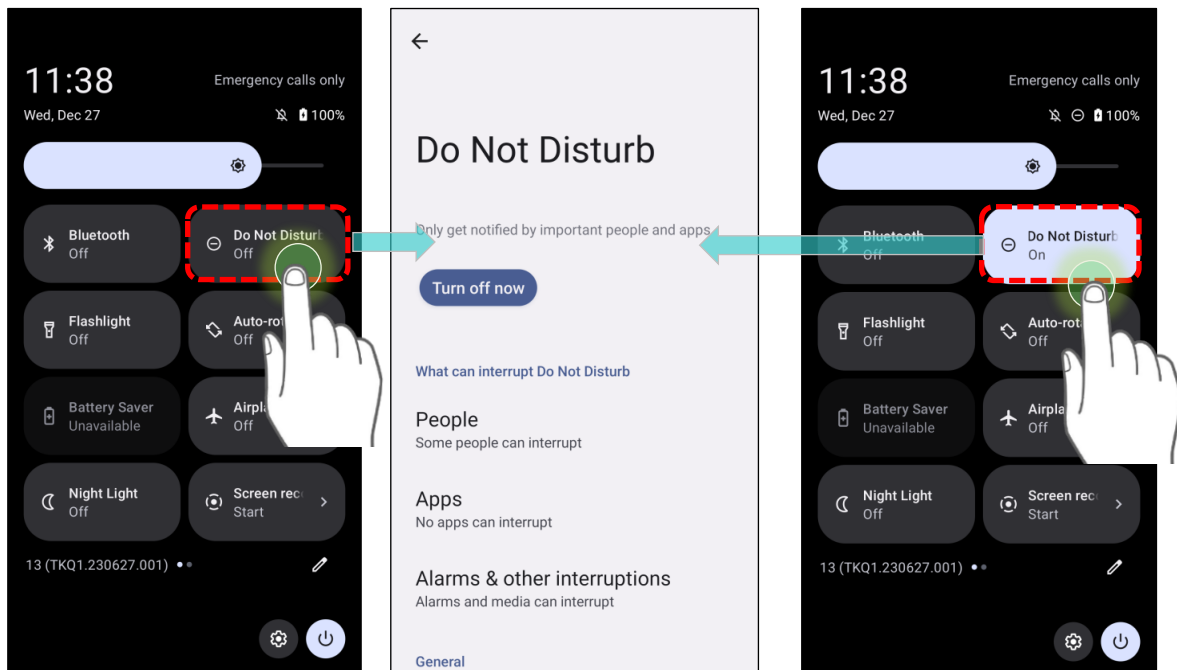
2) Long press the **“Do Not Disturb”** icon in the **Quick Settings Menu** to access additional settings.



Alternatively, go to [App Drawer \(All Apps\)](#) | **Settings**  | **Sound & vibration**  | **Do Not Disturb**.

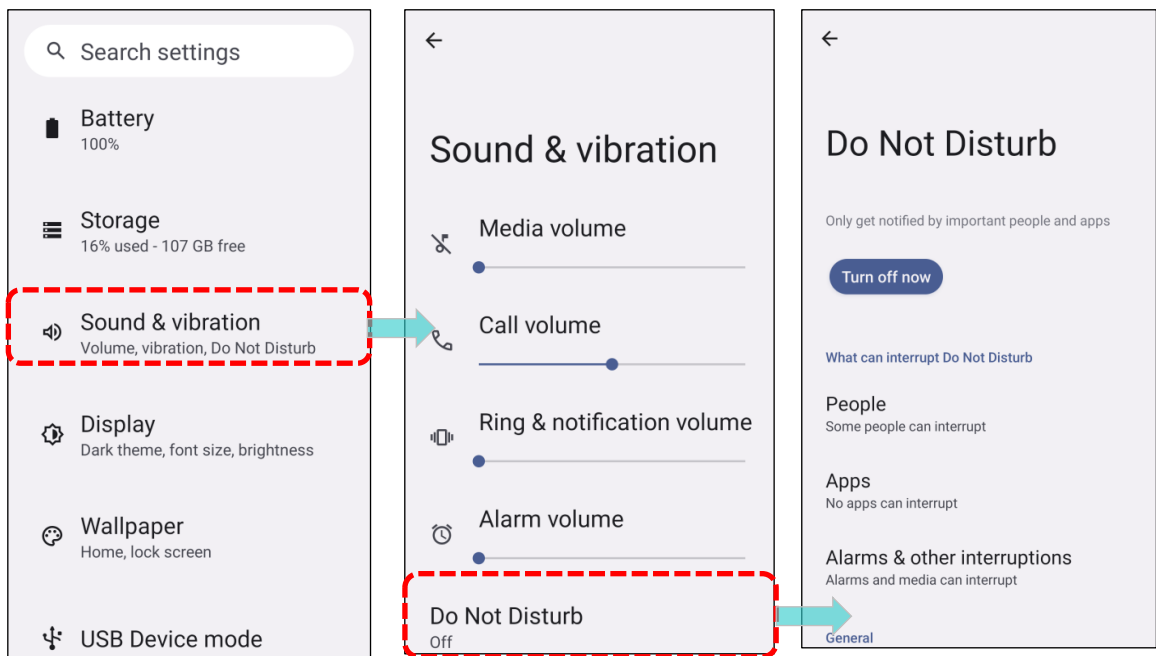

2.5. DATE AND TIME

By default, the mobile computer automatically synchronizes the date and time to the WWAN network (if connected).

To set the date and time manually:

- 1) Go to [App Drawer \(All Apps\)](#) | **Settings**  | **System**  | **Date & time** 

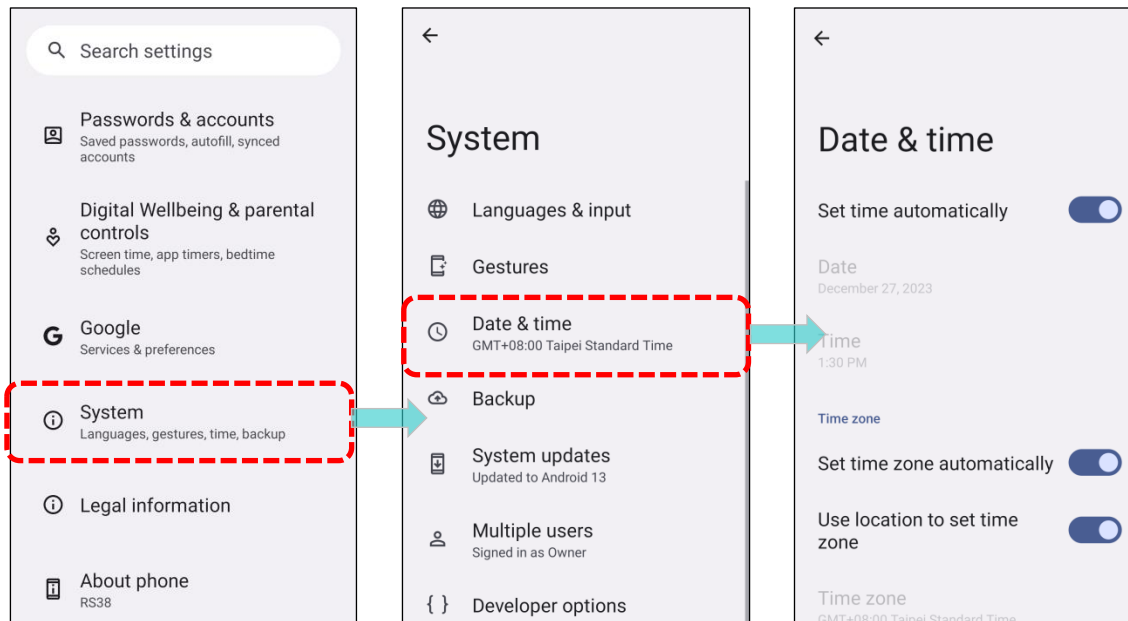

- 2) Tap to disable **“Set time automatically”** and then tap on **“Date”** to choose your desired date.

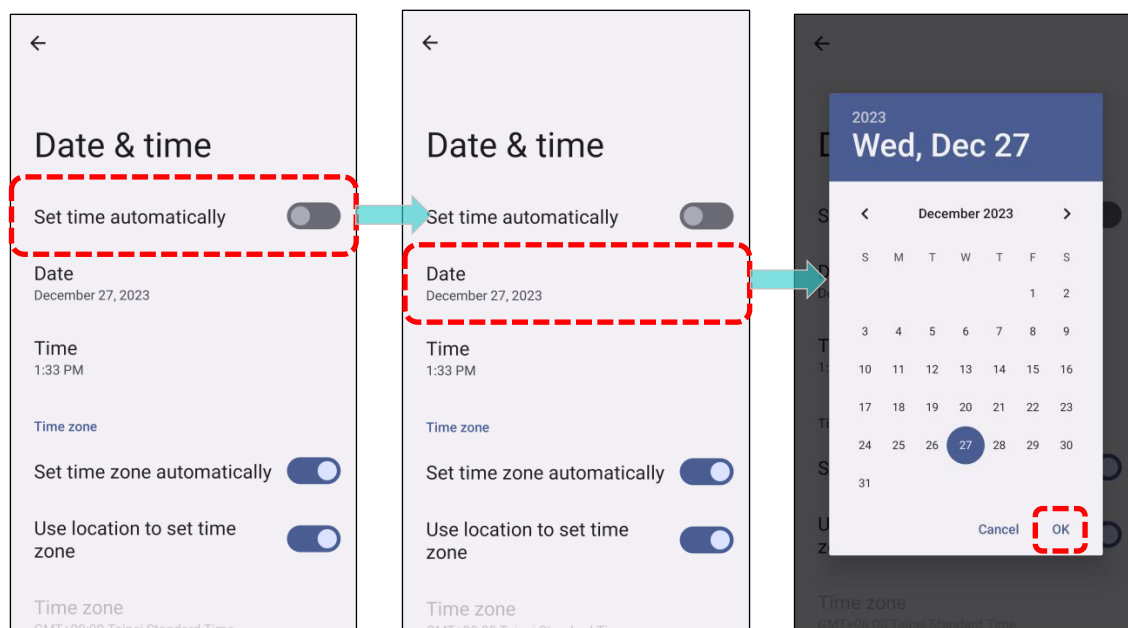

- 3) Continue tapping on **“Time”** to set the correct time.

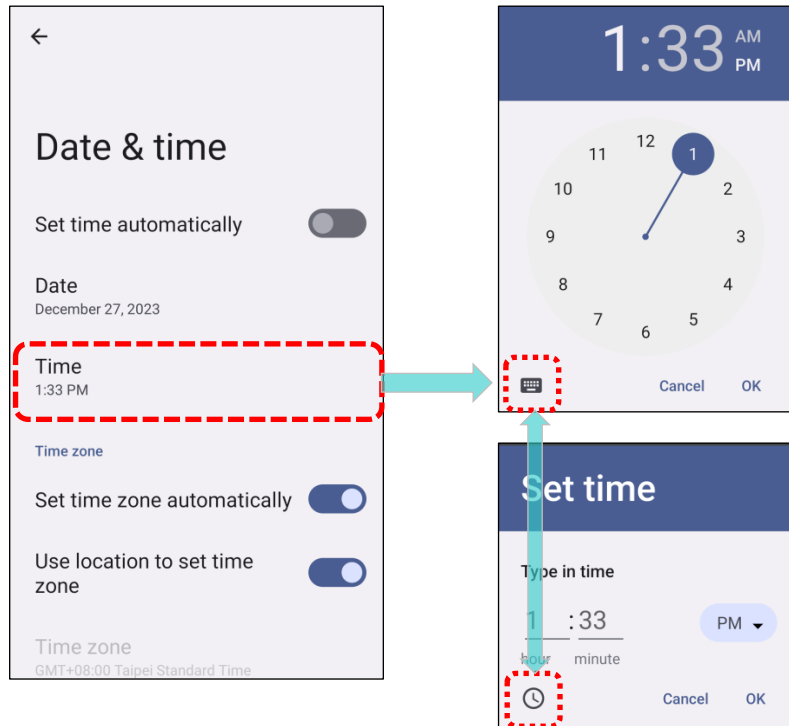

To set time zone manually:

Disable **"Set time zone automatically"** and then tap **"Time zone"** to select the correct time zone by **"Region"**.

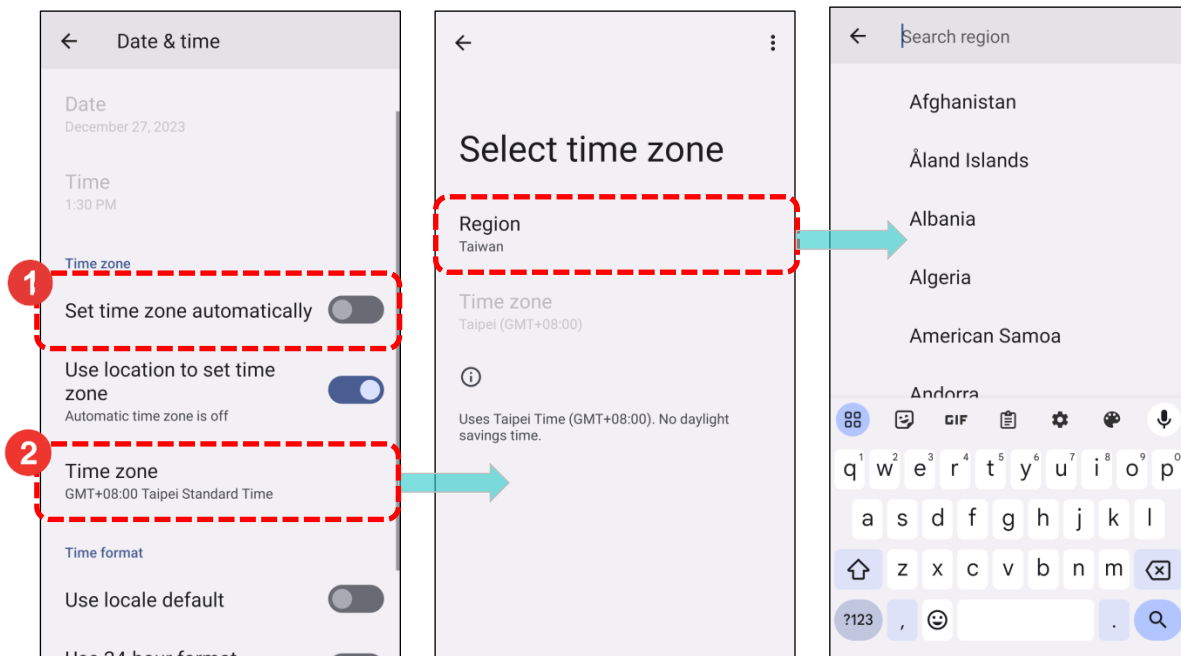

Alternatively, select time zone by **"UTC offset"**

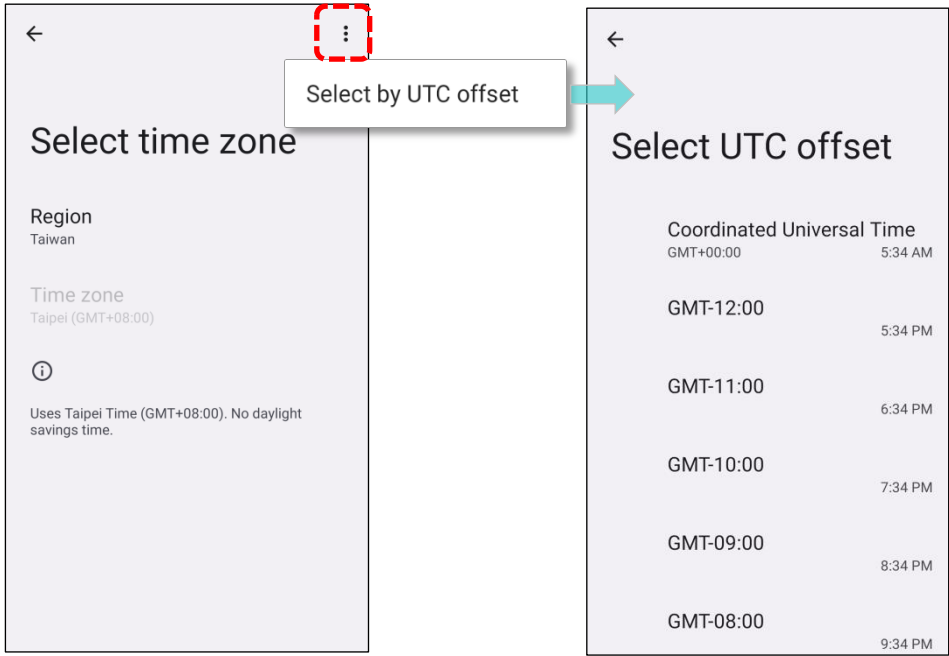

In the bottom page, you can also change the **Time Format** by selecting “**Use locale default**” or “**Use 24-hour format**” to toggle the displayed time.

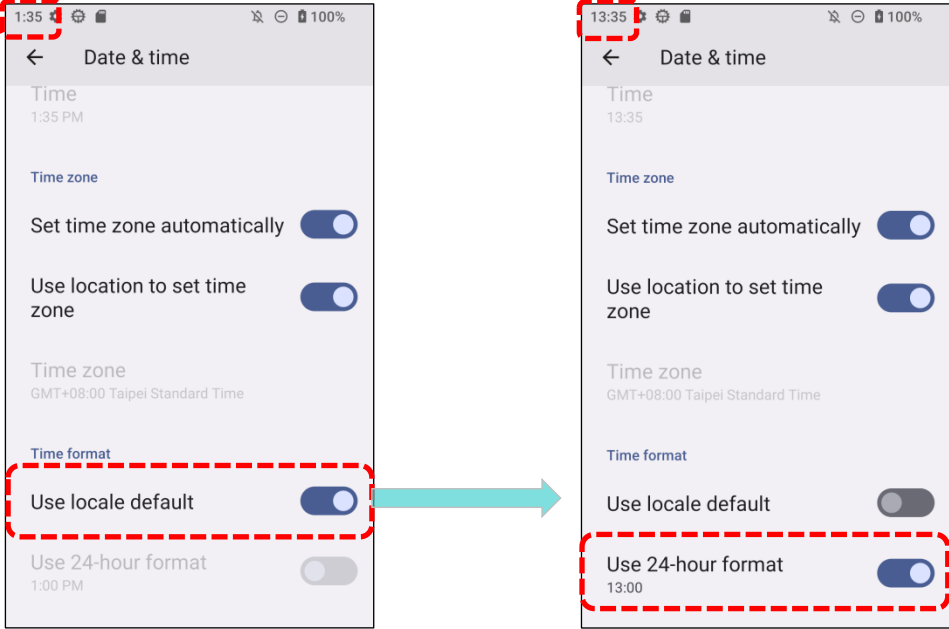

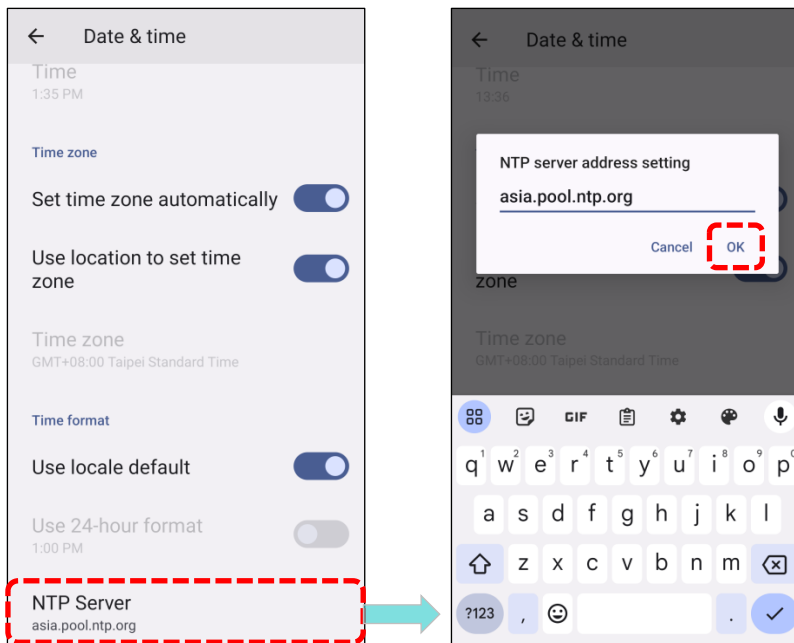

To Sync device time with **NTP server** for accuracy:

Tap "**NTP Server**" on the bottom page to input NTP server address, then tap "**OK**" to save.



2.6. LANGUAGE & KEYBOARD INPUT

Tap [App Drawer \(All Apps\)](#) | **Settings**  | **System**  | **Language & input**  to change the system language, default keyboard type, and configure keyboard input and speech settings.

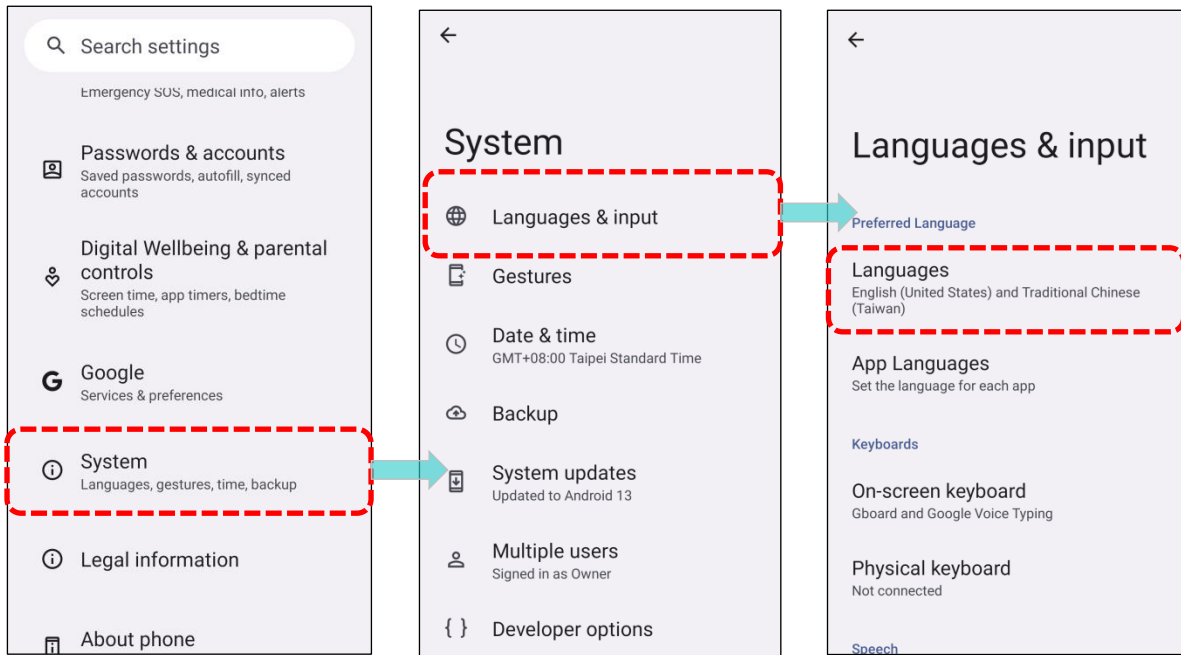

2.6.1. CHANGE DISPLAY LANGUAGE

To change display language:

- 1) On **Language & input** page, tap on **"Language"** to get into Language preference page.

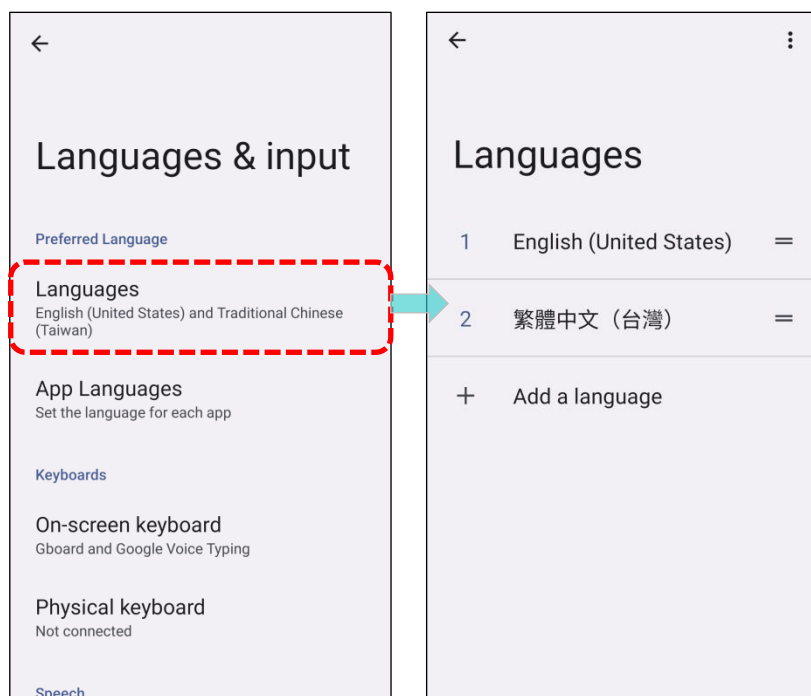

2) Click "Add a language" to select your desired system language.

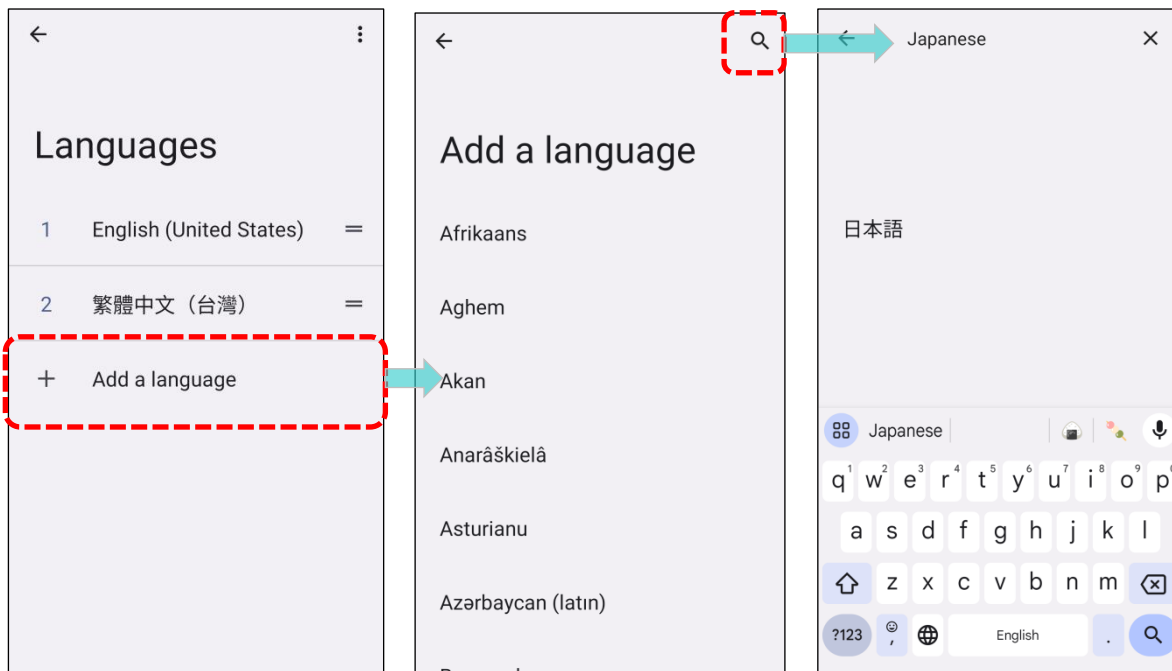

3) Press and hold your preferred system language, then drag it to the top to set it as the primary language. Release to apply the changes instantly.

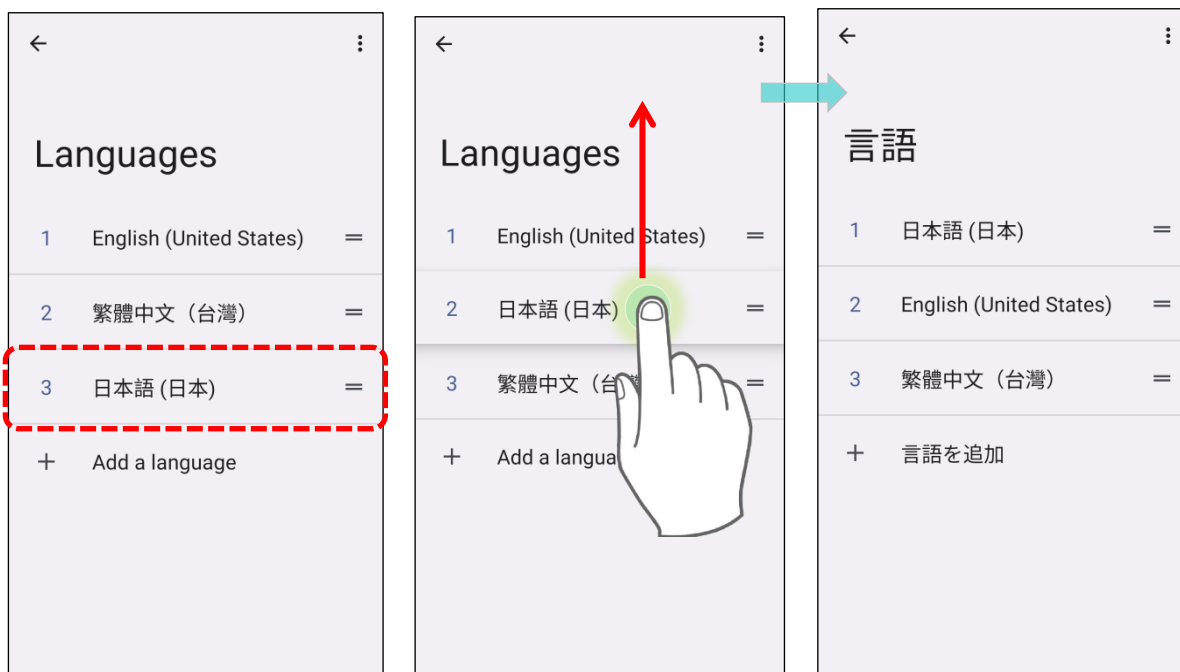

DELETE LANGUAGE

To delete language(s):

- 1) Tap on the more button , then tap "Remove".

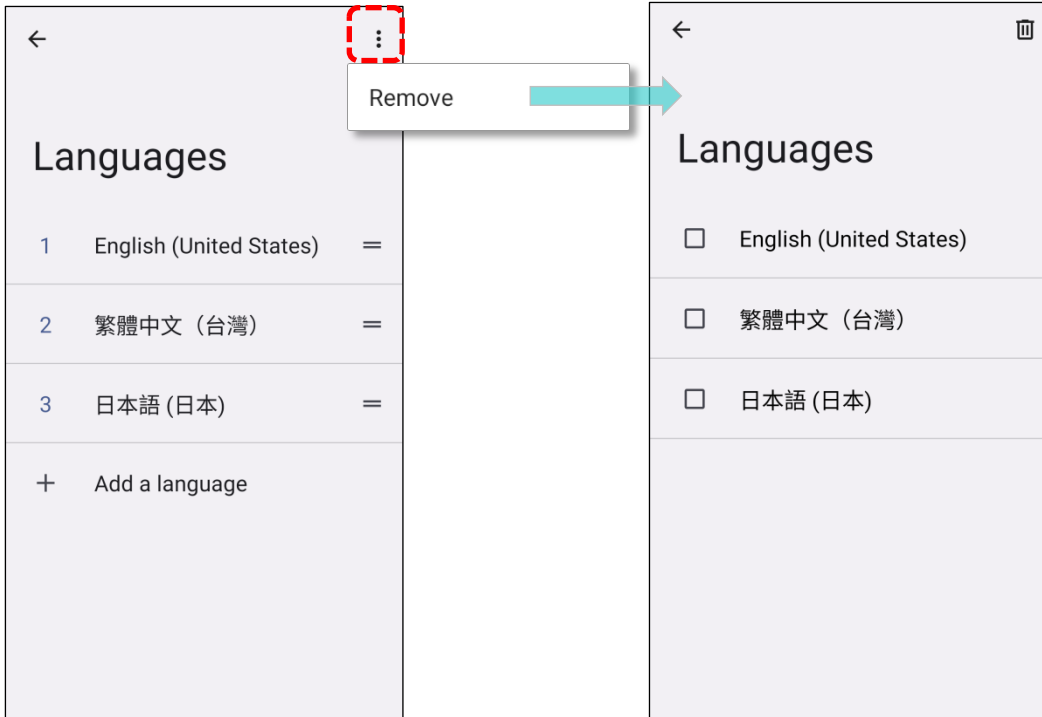

- 2) Select the language to delete. Please note that the display language will be changed once it is deleted.

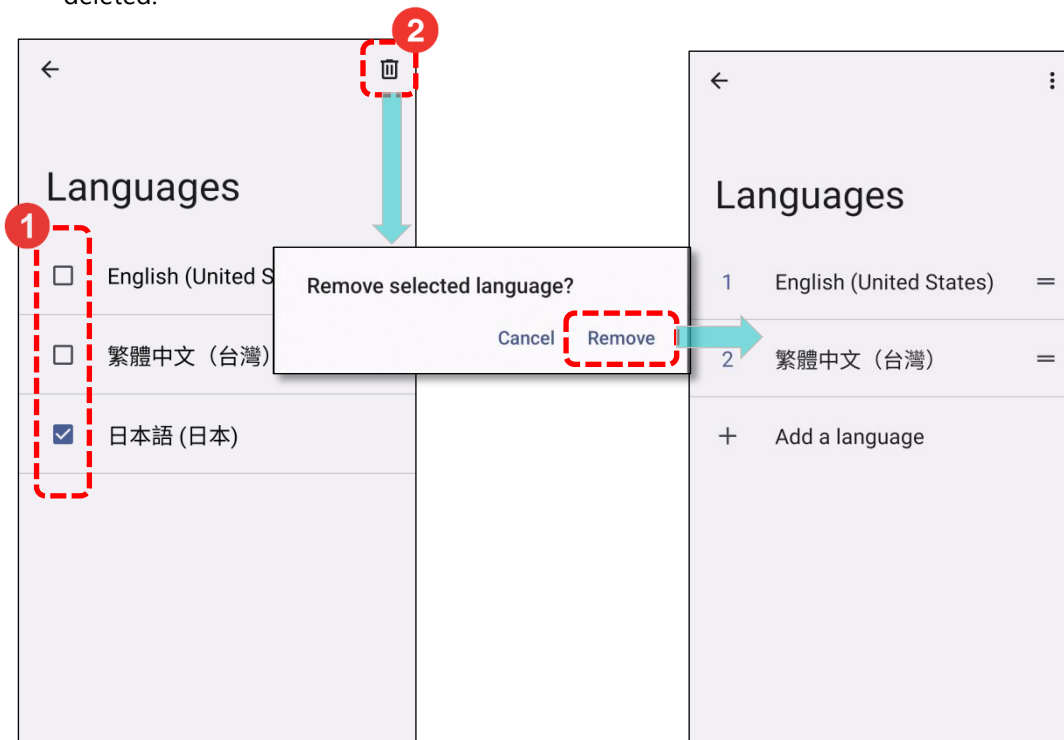

2.6.2. ON-SCREEN KEYBOARD

Simply tap a text input field to automatically open an on-screen keyboard. The virtual keyboard will adapt to the data type (text or numbers) required for that specific field.

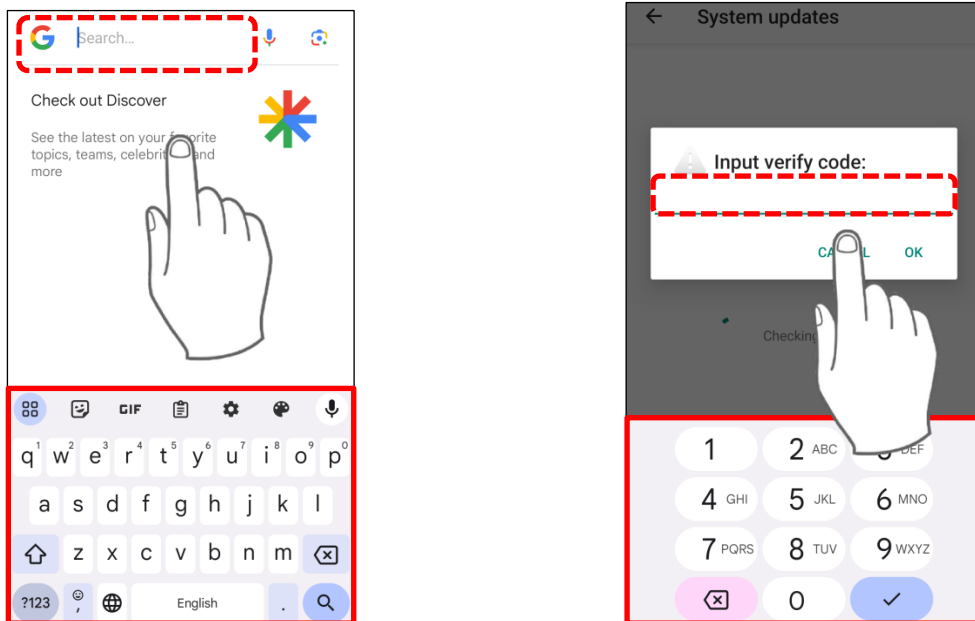

SELECT KEYBOARD (INPUT METHOD)

- 1) To add a language on keyboard, tap **System** ⓘ | **Language & input** 🌐 | **On-screen keyboard**.
- 2) Tap **Gboard** 📱 | **Languages** | **Add keyboard** to pick a language.
- 3) Choose the layout you would like to use, then tap **Done**.

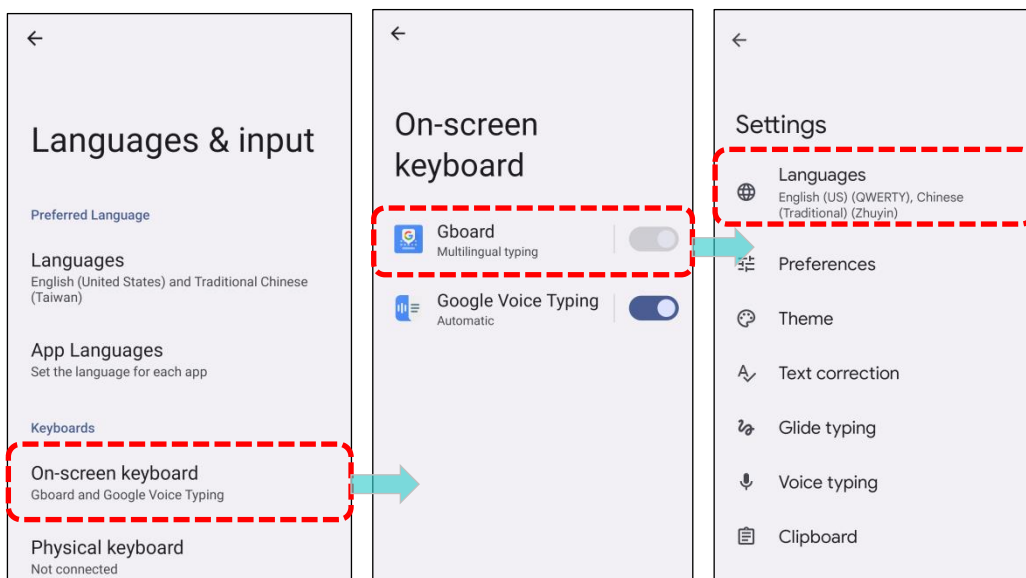

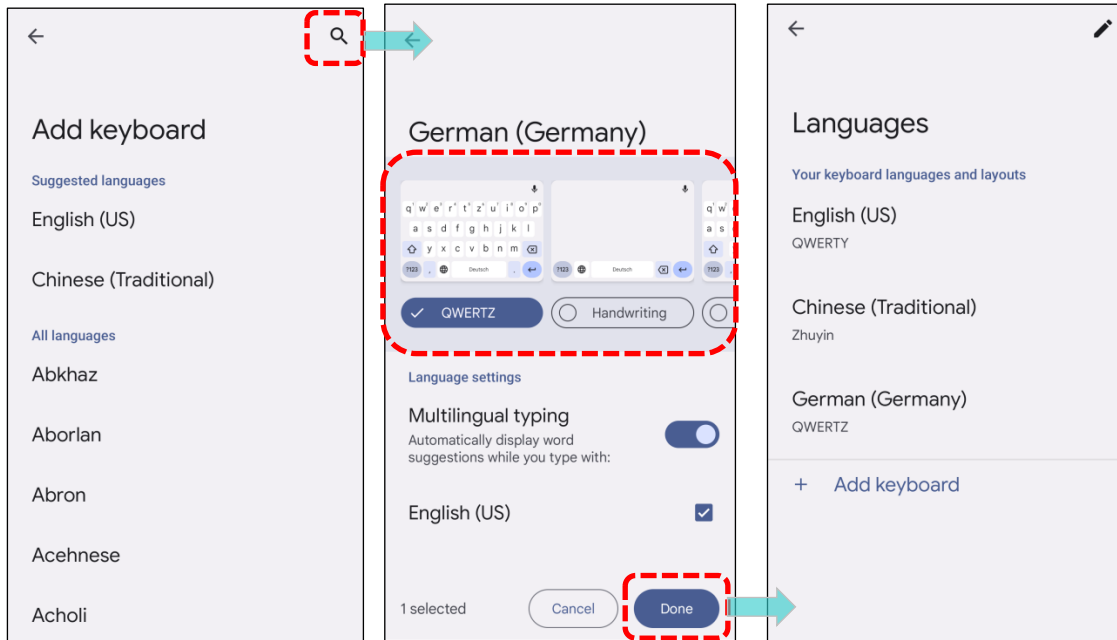

EDIT TEXT

Tap and hold text on the screen to open a text editing menu, allowing you to select all, copy, or paste text within or across applications.



2.7. SOUND AND VOLUME

Adjust system and ringer volume by using the volume buttons located on the left side of the mobile computer.

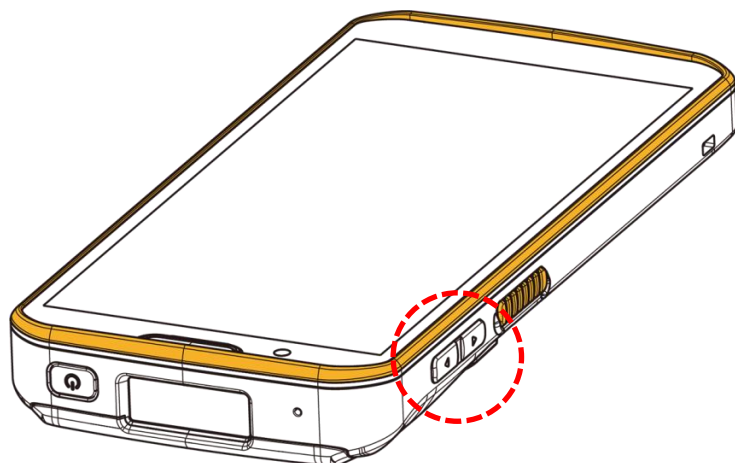

2.8. DATA CAPTURE

2.7.1. BARCODE READER

Select from a range of scan engines to enhance flexibility, catering to diverse operational requirements. The mobile computer, depending on the integrated scan engine, can scan default barcode symbologies while running the ReaderConfig application. To enable or disable specific barcode symbologies, use ReaderConfig.exe.

2.7.2. DIGITAL CAMERA

The mobile computer features a 16-megapixel rear camera with PDAF autofocus and an integrated LED flash, specifically designed for capturing image data. Activate the camera using the image capture utility to take pictures.

By default, images captured using this camera application are saved as JPG files in the DCIM folder within the device's primary storage.

Chapter 3

CHAPTER 3. BASIC OPERATION

This chapter covers fundamental skills for using the RS38 mobile computer, including home screen navigation, system status checking, and notification management. Subsequent chapters delve into additional utilities for data collection, processing, and transmission within specific applications.

IN THIS CHAPTER

| | |
|------------------------------------|-----|
| 3.1. Home Screen | 98 |
| 3.2. Navigation Method | 101 |
| 3.3. Status Bar | 105 |
| 3.4. Suspend & Lock..... | 115 |
| 3.5. Back up Your Data | 121 |
| 3.6. Reset to Factory Default..... | 123 |

3.1. HOME SCREEN

When your mobile computer is fully charged, activate it by pressing the Power Key for three seconds. This action will prompt the appearance of a locked screen, indicating the device is ready for use.

LOCK SCREEN

To access Home screen, begin by unlocking the Lock screen. Swipe up from the bottom of the screen towards the “unlock”  prmpt. Depending on your [screen lock](#) settings, you may also need to draw a pattern, input a PIN, or enter a password.

APP DRAWER

The “**App Drawer**” contains a list of all installed applications on your device.

To open the **App Drawer**, simply swipe up from the bottom of the screen.

CHANGE HOME SCREEN WALLPAPER

To change Home screen wallpaper:

- 1) Tap and hold any empty spot on the home screen.
- 2) In the menu that appears, tap “**Wallpaper**”.
- 3) Choose the app or source you would like to use.
- 4) Select an image for the wallpaper, then tap “**SET WALLPAPER**”.

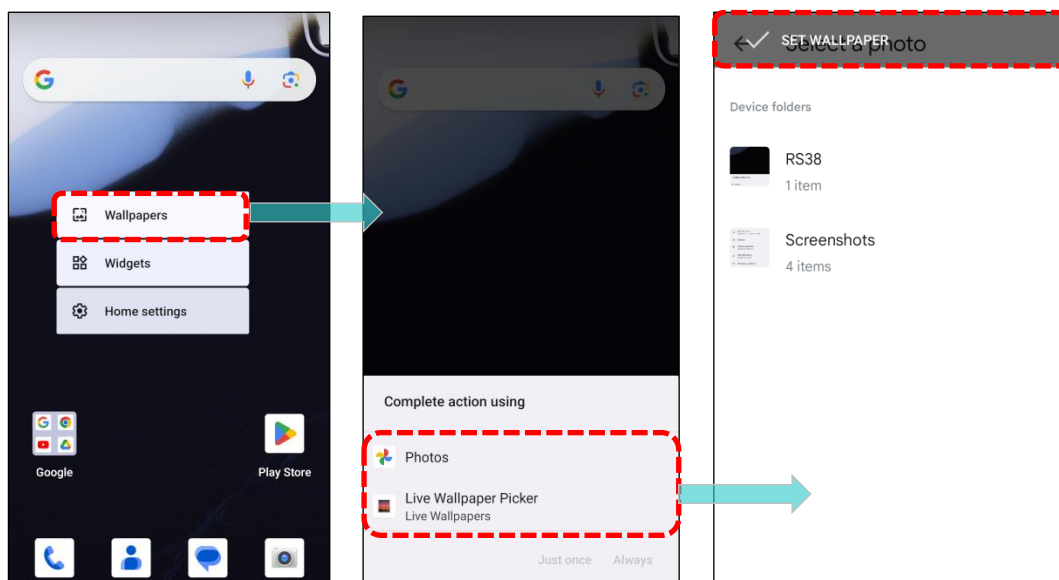

3.1.1. APPLICATION & WIDGET ON HOME SCREEN

ADD APP & APP SHORTCUT TO HOME SCREEN

To **add an application** to home screen:

- 1) Open the [App Drawer](#).
- 2) Locate the application, tap, and hold.
- 3) Drag to the home screen and drop to place.

To **add the app shortcuts** in certain applications to the home screen:

To add such applications from [App Drawer](#) to home screen:

- 1) Open the [App Drawer](#).
- 2) Locate the application, tap, and hold.
- 3) The shortcuts of the app appear under the app icon.
- 4) Tap and hold the desired shortcut of the app.
- 5) Drag to the home screen and drop to place.

ADD WIDGET TO HOME SCREEN

- 1) Tap and hold an empty spot on the home screen, then choose **“Widgets”** from the menu.
- 2) Scroll in the widget list to find your desired widget.
- 3) Tap and hold the widget, drag it to your preferred spot on the home screen, and drop.

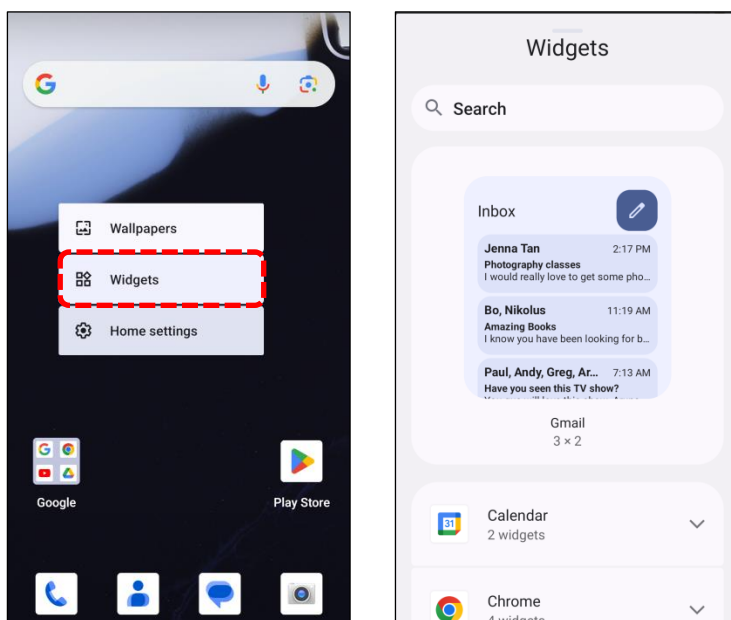

ARRANGE THE APPLICATIONS, SHORTCUT AND WIDGETS ON HOME SCREEN

To move an app, shortcut, or widget on your customized home screen, tap and hold the desired item. Drag it to any location on the home screen. Otherwise, drag the unwanted shortcut/widget to **“X Remove”** on the top of the screen to remove it.

3.1.2 FOLDER ON HOME SCREEN

CREATE AND NAME A FOLDER

- 1) Tap and hold an application or shortcut.
- 2) Drag that app or shortcut on top of another, then drop. As these icons overlap, a folder is created.
- 3) To name the a folder, first tap on it, then tap on the suggested folder name or the **“Edit Name”** to edit.

REMOVE FOLDER

- 1) Tap and hold the folder you would like to remove.
- 2) Drag and drop the folder to **“X Remove”** located on the top of the screen.

Note:

Please note that removing a folder will also result in the removal of all shortcuts contained within it.

3.2. NAVIGATION METHOD

Navigation is to set how you control the device by using swipes and other actions or tapping on buttons.

3.2.1. CHANGE THE NAVIGATION METHOD

The default navigation method is 3-button navigation which appears as the menu bar on the bottom of the screen.

To change your navigation method, please:

Go to [App Drawer \(All Apps\)](#) | **Settings**  | **System**  | **Gesture**  | **System navigation.**

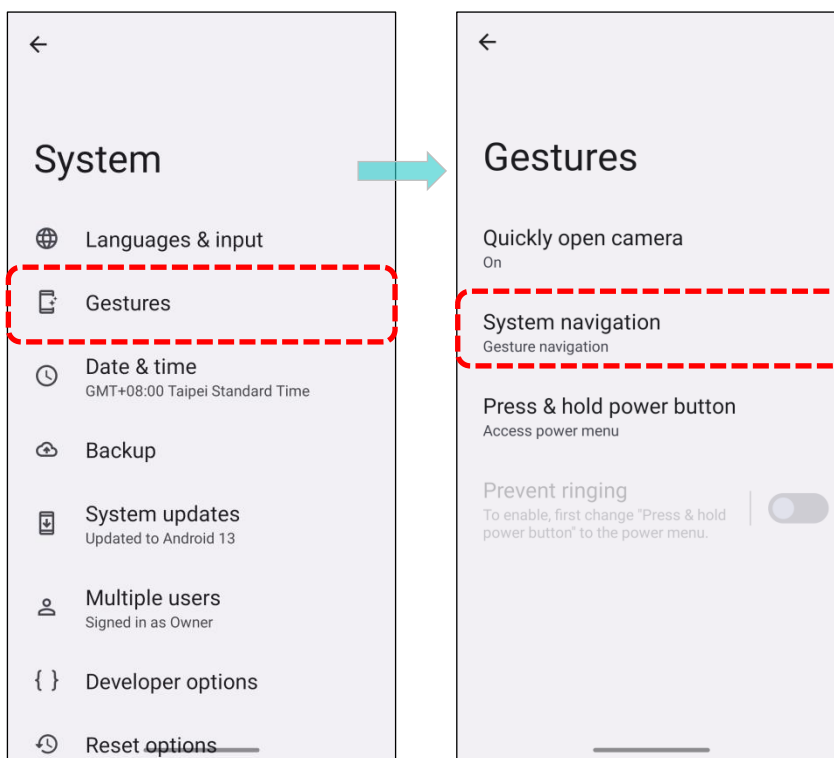

The available options are:

- Gesture navigation
- 3-button navigation (default)

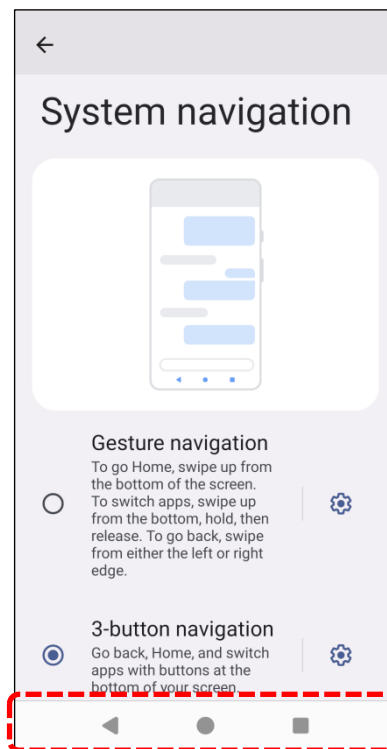
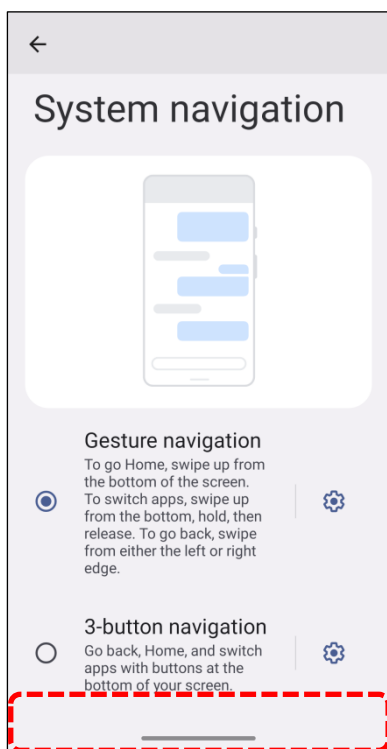

GESTURE NAVIGATION

“**Gesture navigation**” enables screen and menu navigation through gesture-based controls rather than buttons. Once enabled, you can control the device screen using the following gestures:

| Action | Gesture |
|--------------------|---|
| Home | Swipe up quickly from the bottom of the screen. |
| Back | Swipe on either the left or right edge of the screen. |
| Recently Used Apps | Swipe up from the bottom of the screen, pause briefly, and then release. |
| Google Assistant | Swipe up from one of the bottom corners toward the middle of the screen, pause, and then release. |
| App Menus | Swipe on the screen from the left side or right side with two fingers. |

Tap on the setting button  to enter “**Gesture Settings**” page. Here, you can set how far you need to swipe from the screen's edge to trigger the “**Back**” gesture. Higher sensitivity means a greater distance from the screen edge is required.

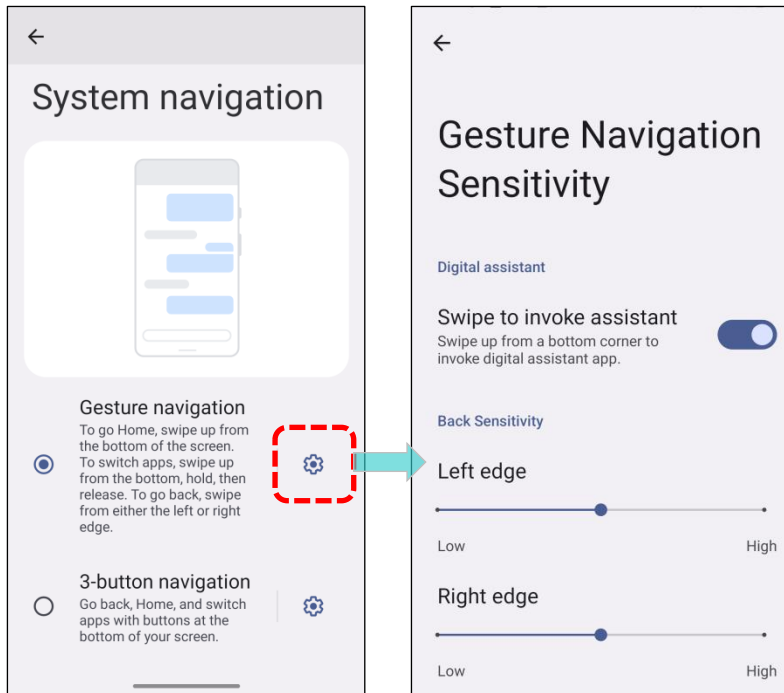

3-BUTTON NAVIGATION

The default navigation method is 3-button navigation, which includes **Home**, **Back**, and **Recently Used Apps**.

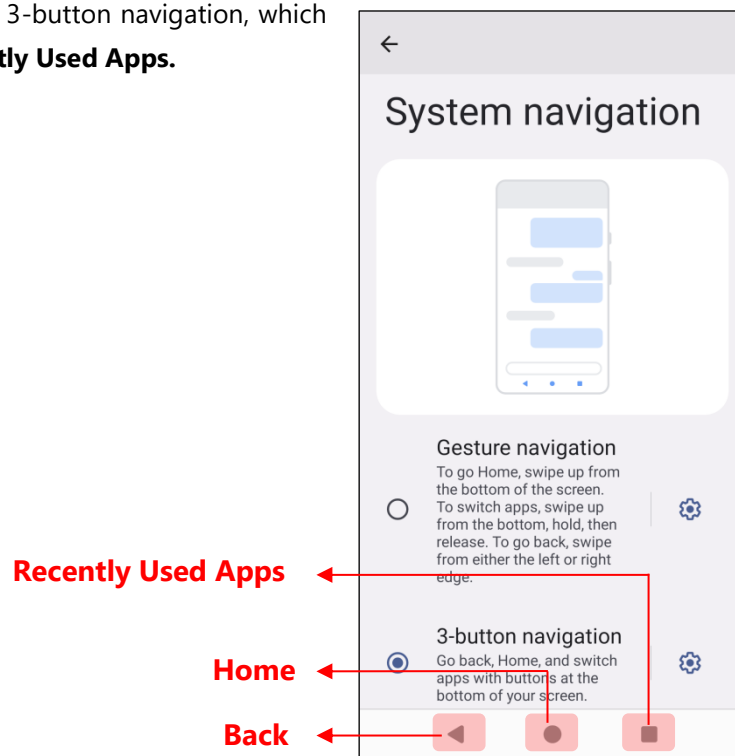

3.2.2. RECENTLY USED APPLICATIONS

To reveal the **Recently Used Apps Menu**, you can:

- For "Gesture navigation":
Slowly swipe up from the bottom of the screen **and hold for a second** before releasing your finger.
- For "3-button navigation":
Simply tap on the **"Recently Used Apps"** button.

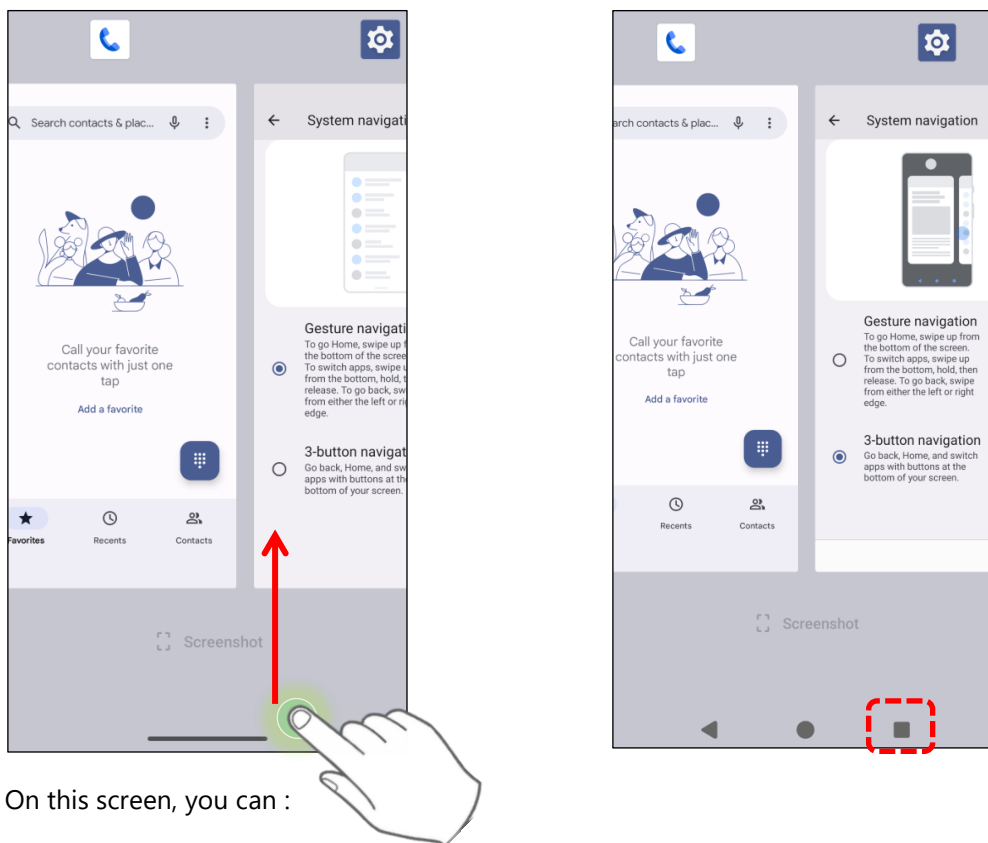

On this screen, you can :

SWITCH BETWEEN APPLICATIONS

Swipe left or right to browse listed applications, then tap your desired one to open it.

END APPLICATION

Swipe an application upward to close it.











Note: Free up RAM by closing unused applications. Ensure to save your data or settings before closing any app.

3.3. STATUS BAR









The left side of the status bar displays **notification icons**, while the right side shows **status icons**.

3.3.1. ICONS ON STATUS BAR

NOTIFICATION ICONS

| Icon | Description |
|---|--|
|  | Receive system notifications like “USB debugging connected” or USB file transfer turned on ” on Android. Open Notifications Drawer for more details. |
|  | The device is syncing data |
|  | There is an upcoming event. |
|  | The device is downloading data. / Download completed. |
|  | The device is uploading data. / Upload completed. |
|  | An open Wi-Fi network is available. |
|  | A memory card has been inserted. |
|  | The headset has been inserted. |
|  | Wi-Fi hotspot is active. |
|  | Wi-Fi will turn on automatically when there's the saved network with a strong signal nearby. |

STATUS ICONS

| Icon | Description |
|---|--|
|  | The device is currently connected to a Bluetooth device. |
|  | The device is currently connected to a Wi-Fi network and performing data transmission. |
|  | Airplane mode is active, deactivating all wireless radios. |
|  | Alarm is currently active. |
|  | All sounds are silenced except for alarms, which are set to Vibration mode. |
|  | The main battery is fully charged. |
|  | The main battery is partially depleted. |
|  | The main battery level is critically low and requires immediate charging (<15%). |
|  | An external power source is connected, and the main battery is currently charging. |

3.3.2. OPEN QUICK SETTING MENU

Quick Settings in the status bar provide easy access to essential device settings such as power, Bluetooth, and Wi-Fi connectivity, allowing you to make adjustments swiftly.

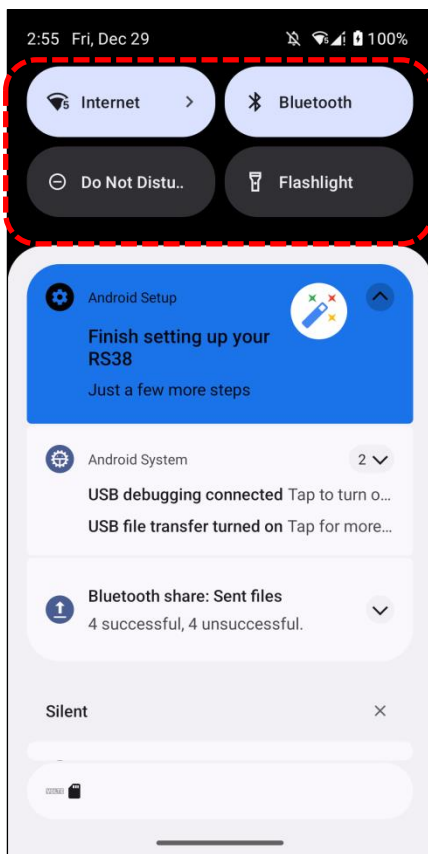

With a short swipe from the status bar, the **Quick Setting Panel** is revealed. Open the **Quick Setting Menu** by swiping from the top to the bottom of the screen. Tap on each status icon to switch modes or access settings.

- Quick Setting Panel

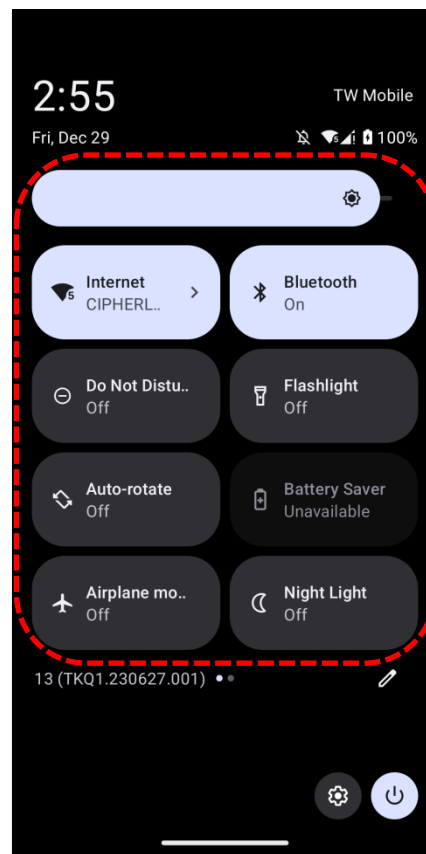

- Quick Setting Menu



Tap on the two buttons,  and , on the bottom side of the **Quick Setting Menu** will respectively enter the below pages:

-  "Edit" Page:

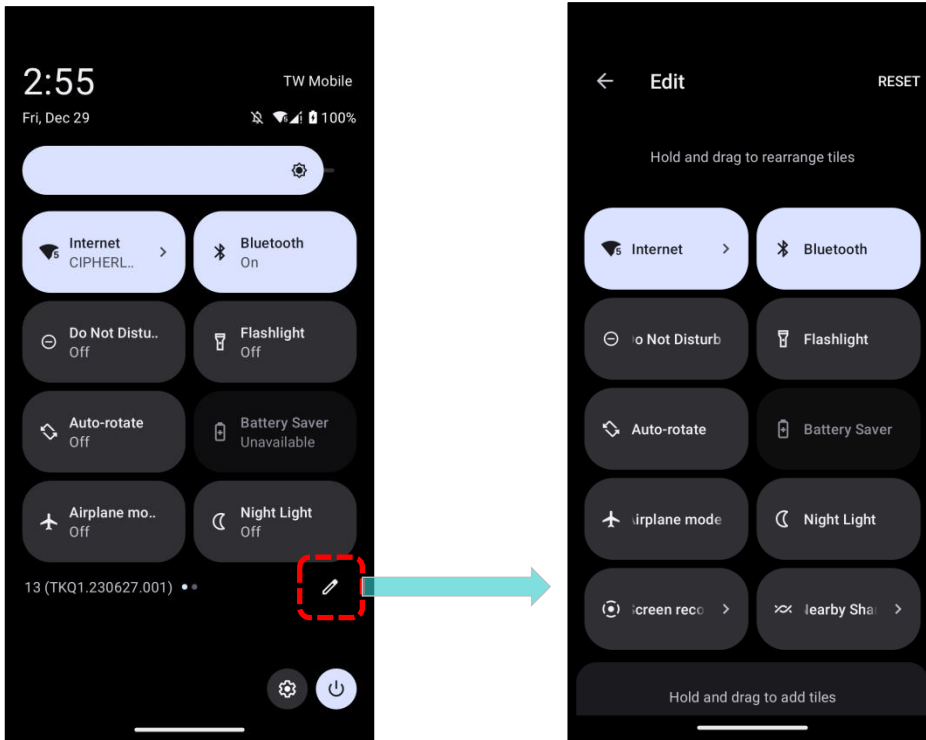

-  "Settings" Page:

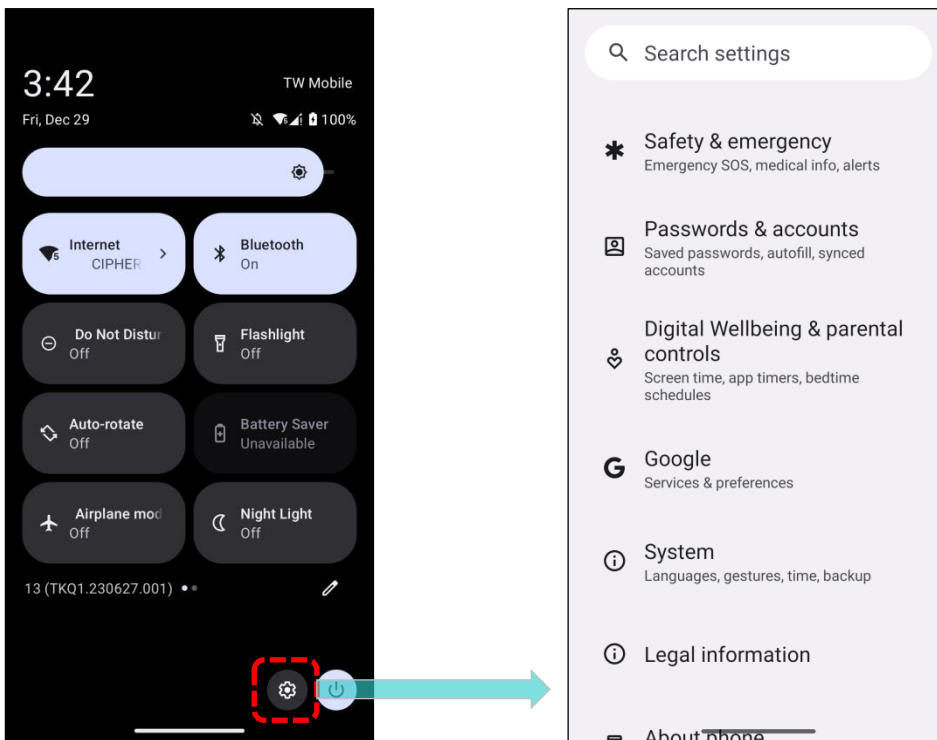

EDIT QUICK SETTING MENU

To customize **Quick Setting Menu**, please:

- 1) Click **"EDIT"**  to get into **Edit** page.

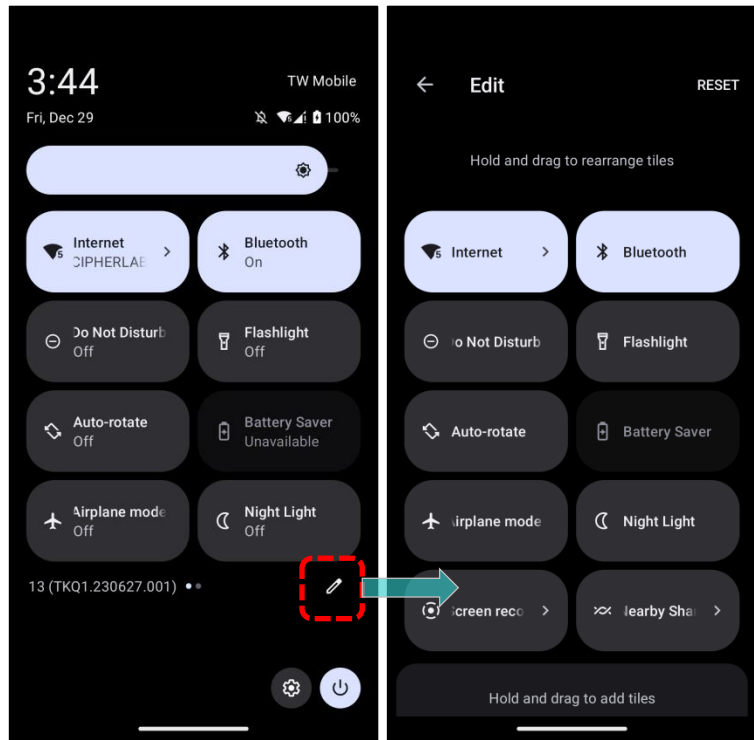

- 2) **Remove:** To remove certain item, please tap on and hold the icon to be removed, and drag it to the **"DRAG HERE TO REMOVE"** area and then release it.

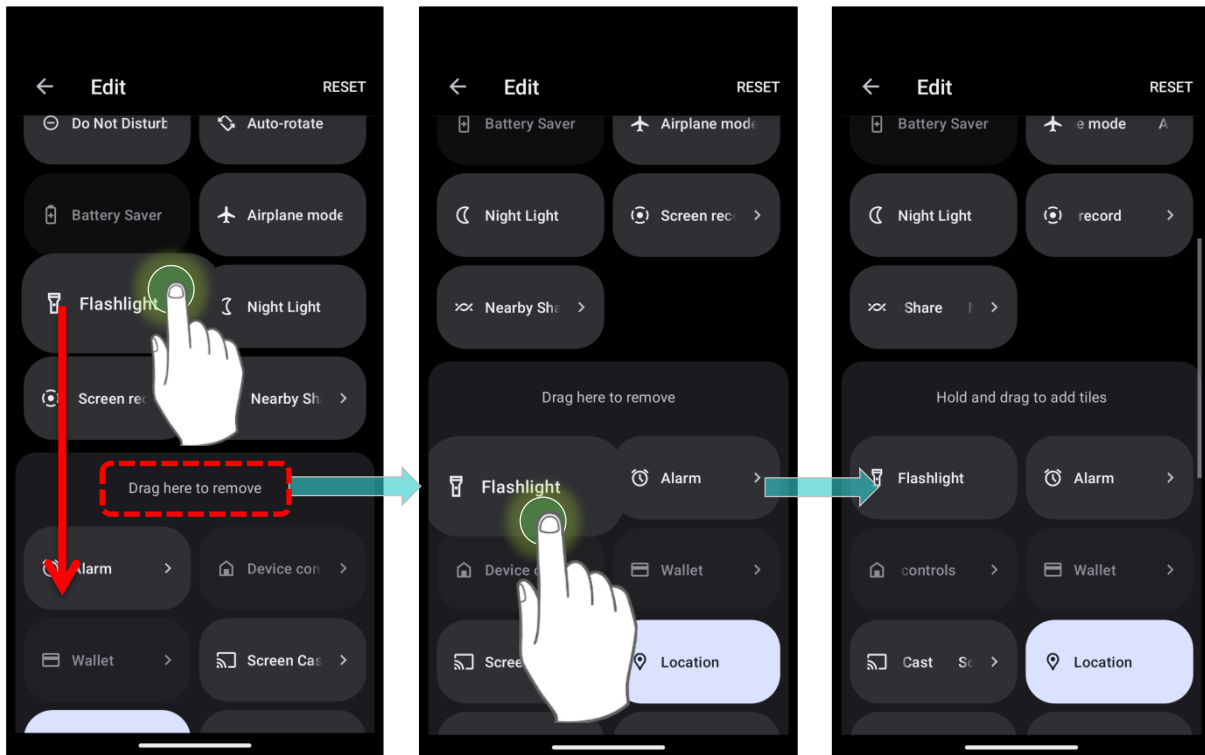

- 3) **Add:** To add certain item, please tap on and hold the icon to be added and drag it to the upper area and then release it.

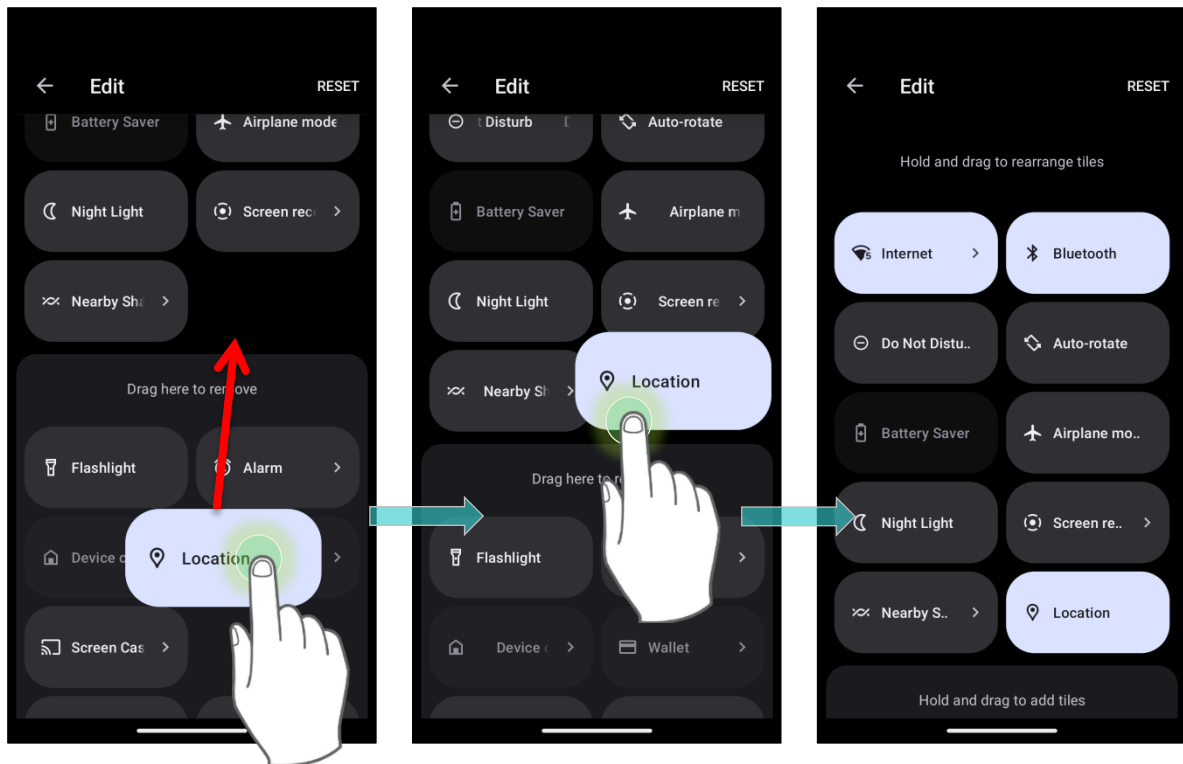

- 4) Return to the **Quick Settings Menu**, all the settings are done.

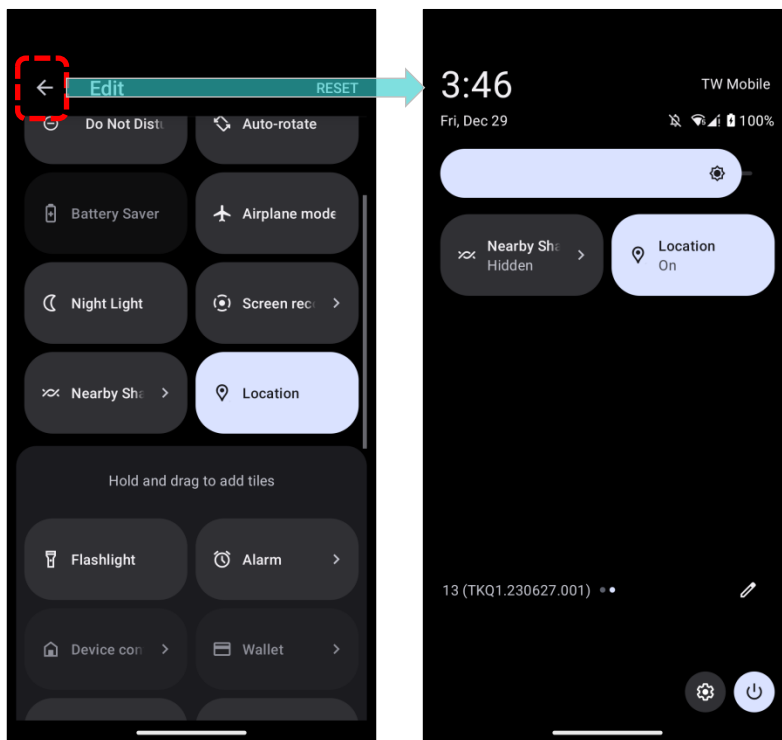

RESET QUICK SETTING MENU

To reset the **Quick Setting Menu**, please:

- 1) Tap "**EDIT**"  to enter **Edit** page.

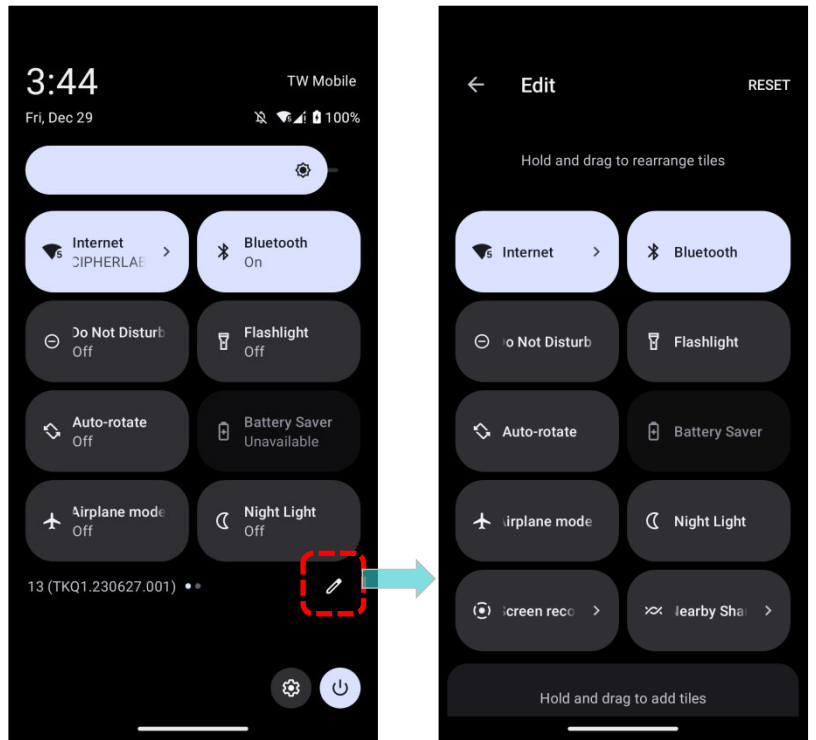

- 2) Tap **Reset** in the upper-right corner.

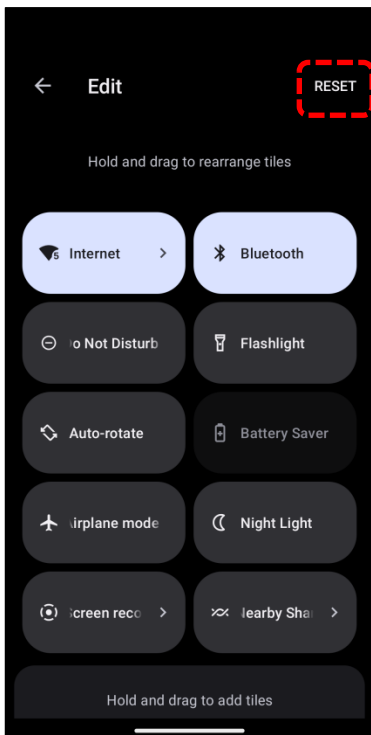

3.3.3. OPEN NOTIFICATIONS DRAWER

Status bar notification icons alert you to new events such as incoming calls, messages, or USB connections.

CHECK OUT NOTIFICATION

To check out details of the events, swipe down from the status bar to open [Notifications Drawer](#).

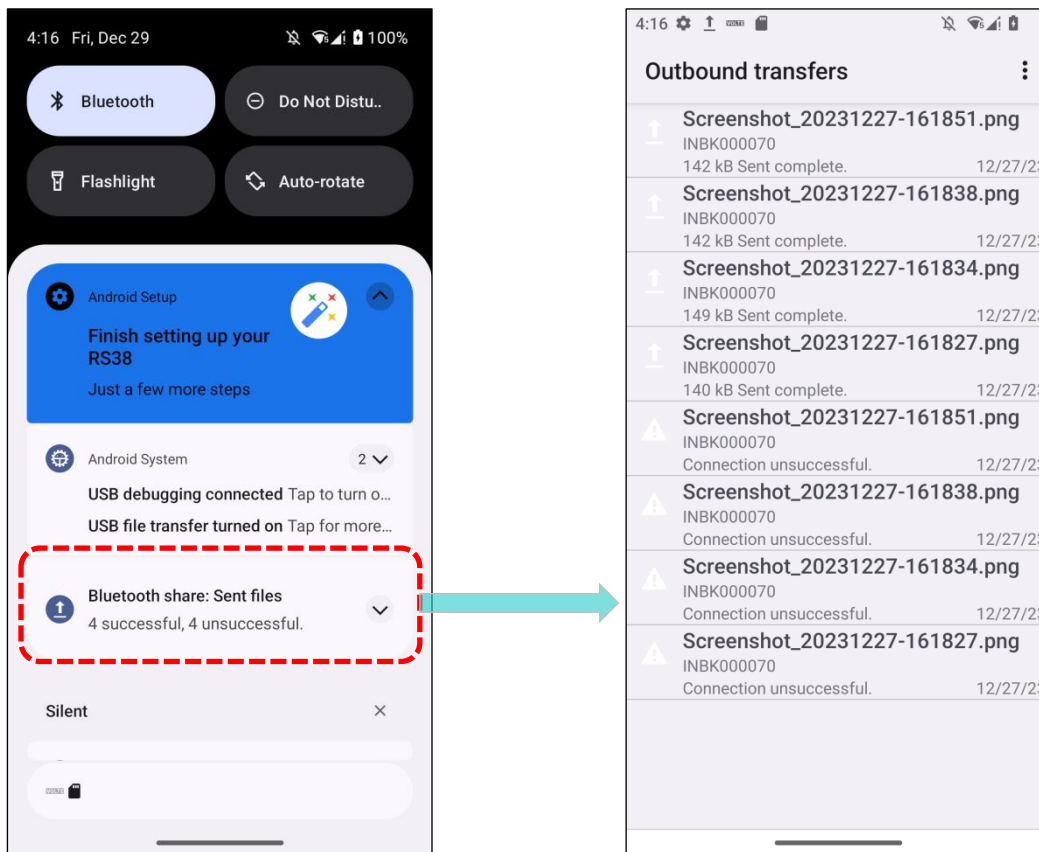

Tap on the notification card to carry out immediate action or to open the corresponding application.

DISABLE NOTIFICATION

You can turn off the notification of a specific app by tapping and holding on the notifications card until the corresponding app name reveals. Tap to choose **“Default”**, **“Silent”**, or **“Turn off notifications”**.

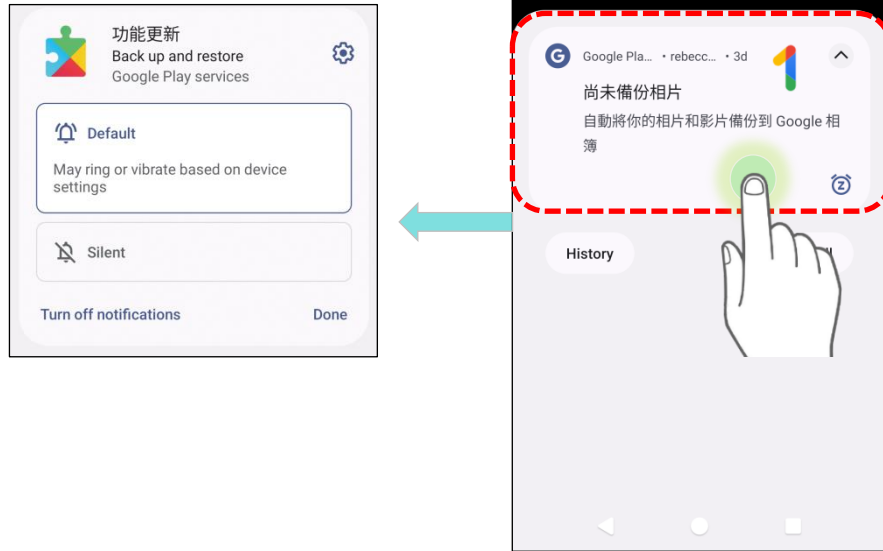

- 1) Go to [App Drawer \(All Apps\)](#) | **Settings**  | **Apps**  | **See all XX apps** to find the app you would like to change its notification settings.

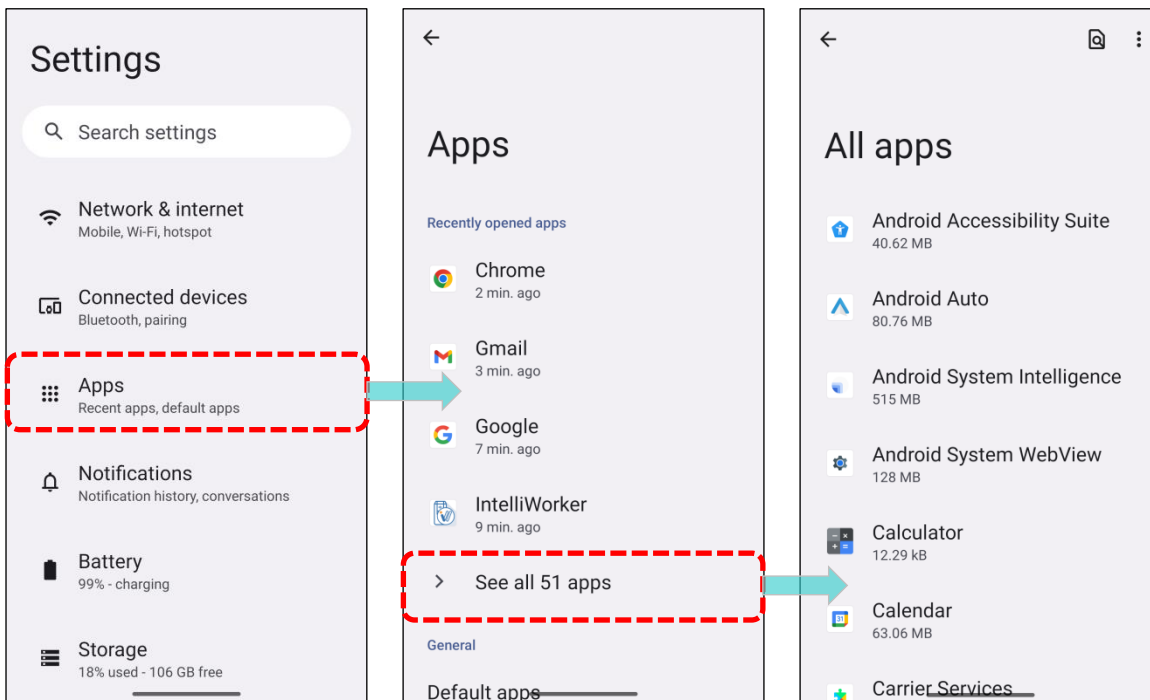

- 2) Tap to enter the “**App info**” page and tap “**Notifications**” to switch on or off “**Show notifications**” and other settings.

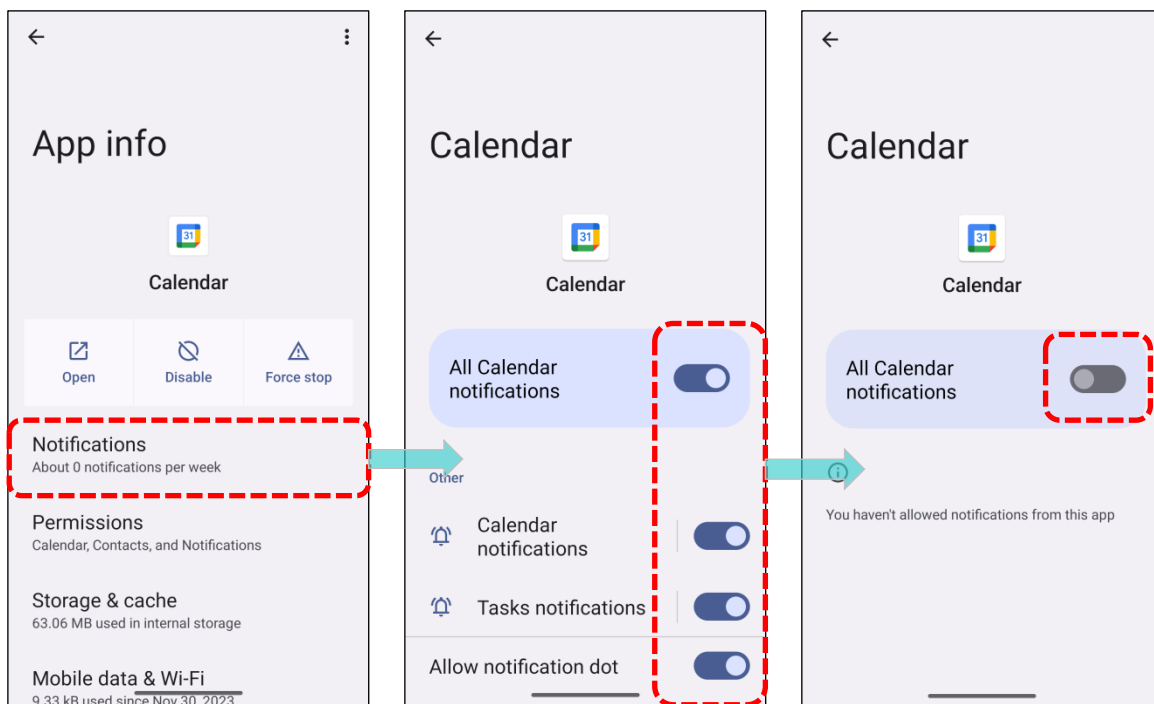

CLEAR NOTIFICATION

To dismiss all notifications at a time, please tap on “**CLEAR ALL**”. Ongoing notifications and notifications that require subsequent activity to be cleared will remain on the list.

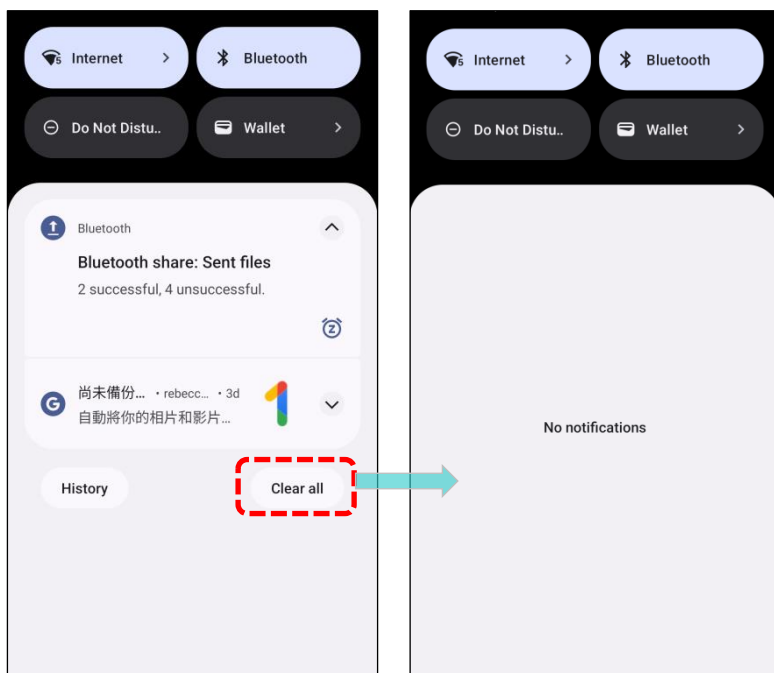

3.4. SUSPEND & LOCK

3.4.1. SUSPEND DEVICE

The mobile computer operates continuously once it is powered on. To minimize power consumption and prevent unintended operation, suspend the mobile computer if you are not actively using it. The mobile computer can be quickly awoken from suspend mode to operate as needed. When the mobile computer enters suspend mode, the system is in a power-saving status, meaning the device will not respond to screen touch, and volume keys and side buttons will also be unavailable until the device is unlocked.

SUSPEND RS38

Press the power button to suspend the mobile computer. The mobile computer will automatically suspend when the time period set in [Screen Timeout Settings](#) has passed without any activity.

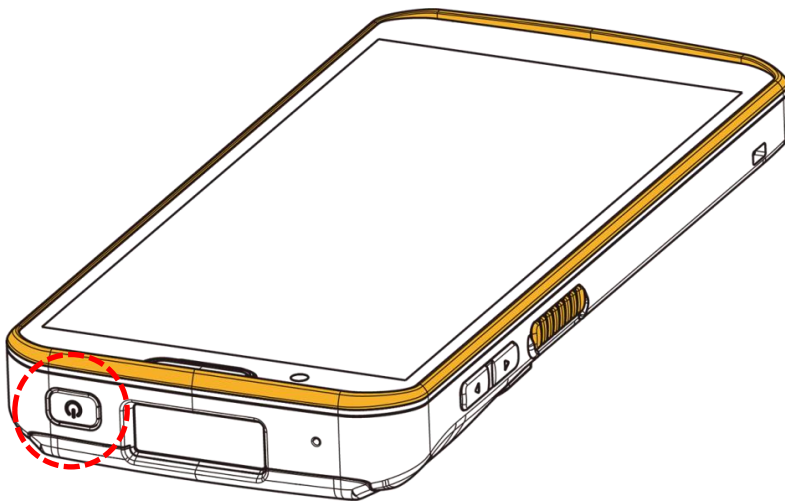

Power Button





3.4.2. LOCK DEVICE

Setting a screen lock allows you to protect your personal data on the device when it's not in your possession. With various screen lock options available, including Smart Lock, you can enjoy enhanced security and convenience.

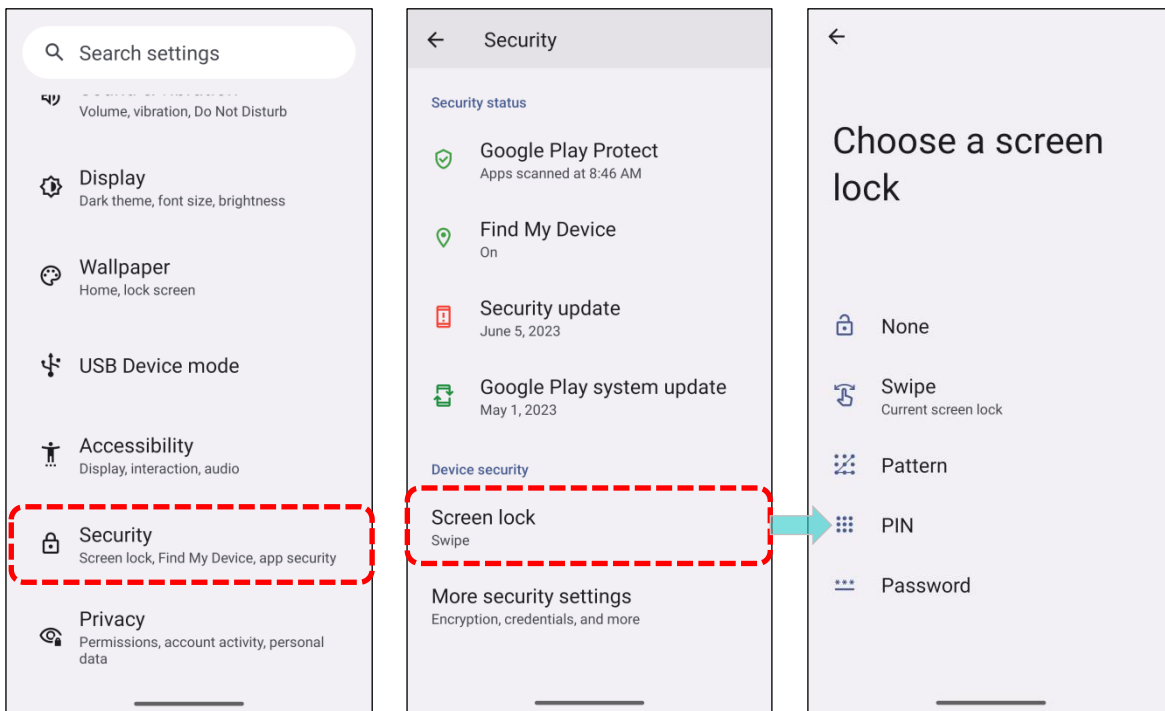
LOCK RS38

Go to [App Drawer \(All Apps\)](#) | **Settings**  | **Security**  | **Screen lock** to change the lock method.



| Icon | Item | Description |
|---|----------|--|
|  | None | Disable screen lock. |
|  | Swipe | Default slide gesture. |
|  | Pattern | Enter a pattern to unlock. |
|  | PIN | Uses the PIN code to unlock. |
|  | Password | Enter a password of at least 4 characters to unlock. |

By selecting a **Pattern, PIN, or Password** method, a setting icon appears next to **“Screen lock”**. Tap to enter **“Screen lock”** page for further configurations.

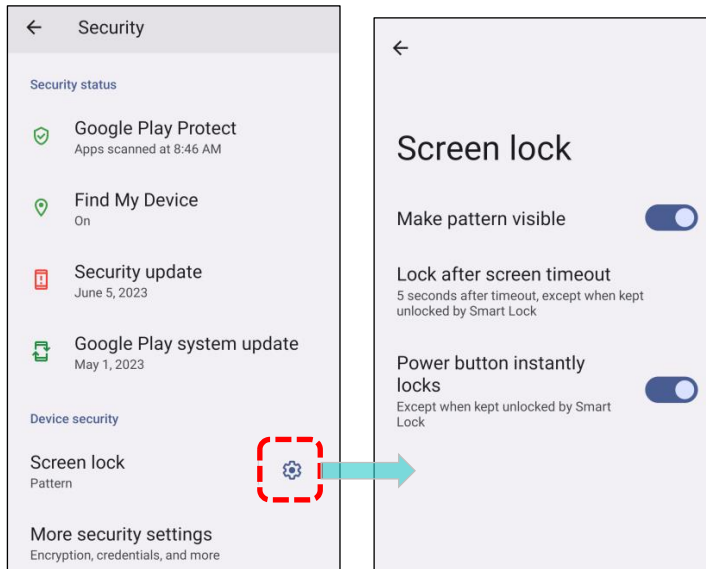

Screen Lock advanced settings are:

| Item | Description |
|-----------------------------|---|
| Lock after screen timeout | Set the time interval between <u>screen timeout</u> and automatically locking the screen. |
| Power button instantly lock | Switch to enable/disable instantly lock screen by pressing power button. |

You can also access **Smart Lock** to customize personal lock settings.

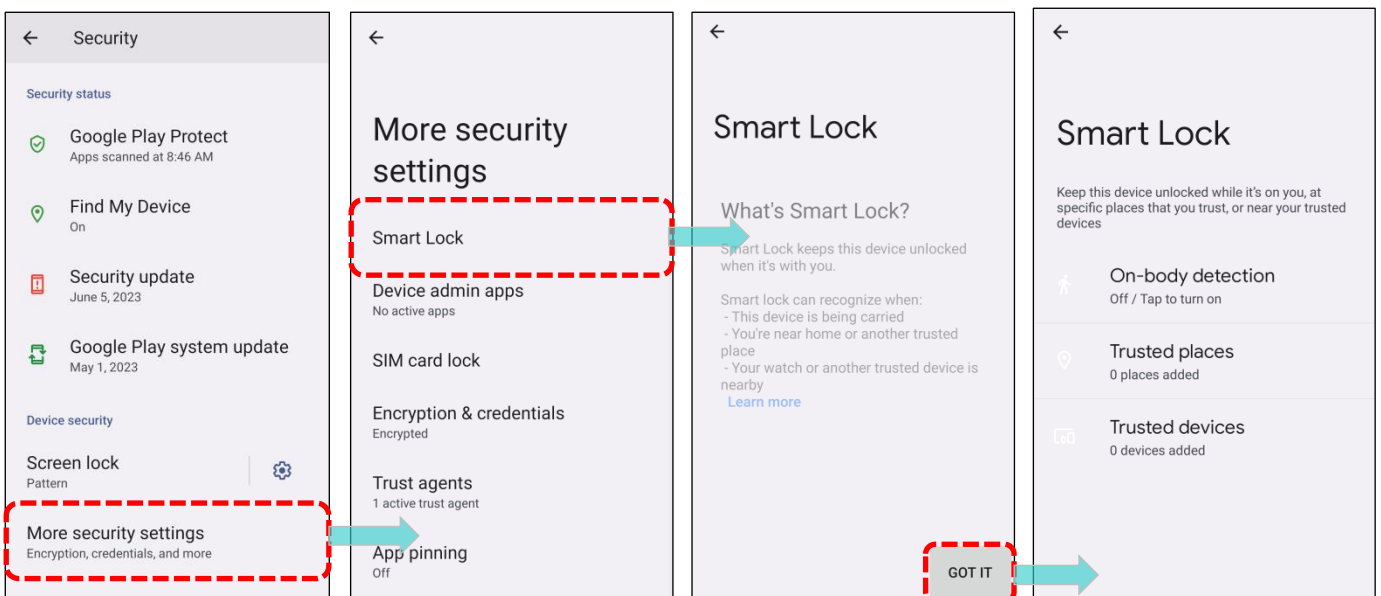

3.4.3. OS UPDATE

Updating the operating system on the mobile computer helps maintain it at an optimized state. You may choose to update the system by establishing a wireless network connection to the Internet and downloading the update file from the OTA server.

Note: The mobile computer will shut down during system update. Save any unfinished tasks and data before updating the system in order to avoid data loss.

3.4.4. NETWORK UPDATE

In order to check for and download the latest system update file on the server, make sure a wireless network connection to the Internet is established on the mobile computer.

Note: To avoid any additional charges to your wireless data plan, Wi-Fi connection to the Internet is recommended for downloading the file.

- 1) Go to [App Drawer](#) | **Settings**  | **System**  | **System updates** .

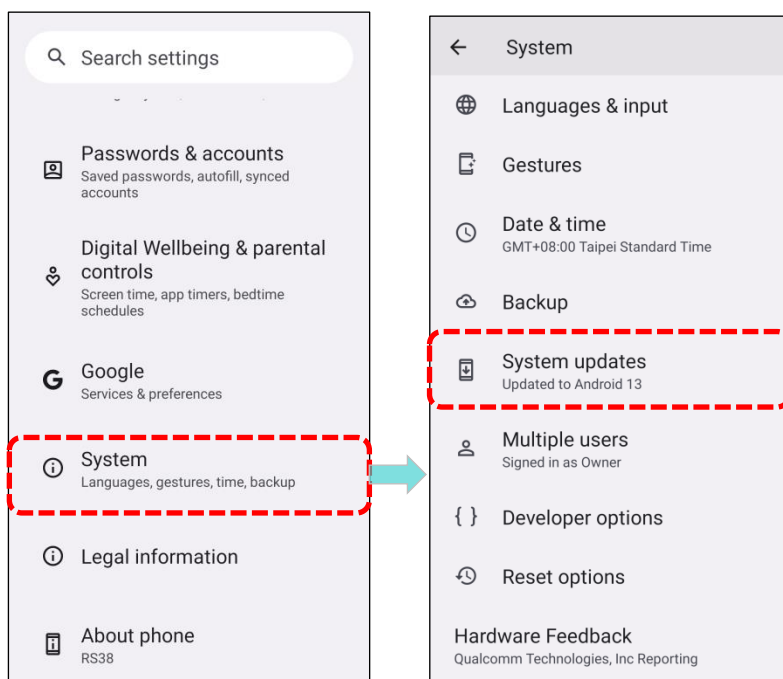

-
- 2) A window pops up asking you to input the password for system update. Please contact with support@cipherlab.com.tw for the password. Enter the password and tap "OK".

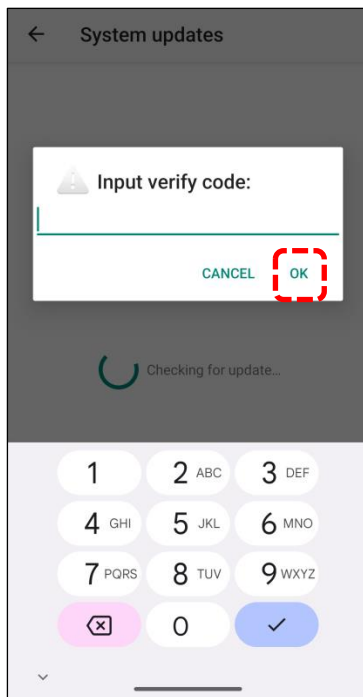

- 3) The mobile computer searches for the latest system update file on the server. Tap **DOWNLOAD AND INSTALL** to download the update file.
- 4) When a new system update file is detected on the server, a notification icon will appear on the status bar, and a text notification will pop up in the notifications panel.

AUTOMATIC UPDATE

The automatic update feature of RS38 mobile computer is off by default, and you can change the setting by **ADC** (Android Deployment Configurator) to turn it on.

By enabling automatic update feature, RS38 mobile computer automatically detects whether there's the latest OS update and downloads it. The update is scheduled to proceed on early morning when the device is on and left idle.

3.4.5. SD CARD UPDATE

RS38 mobile computer automatically searches the available update files in your mobile computer's storage and then install it.

Please obtain the latest system update image file, and then rename and copy the file as "**sdupdate.zip**" onto the folder "**sdupdate**" of your SD card. Insert the SD card into the memory card slot on the device. Press the power button to power it on.

Alternatively, transfer the update image file to the root directory of the device's internal storage via a USB Type-C cable.

The newest version of OS will be automatically installed and take effect next time the device is booted up.

Note:

Make sure the SD card is properly inserted in the mobile computer; otherwise, the system is considered up-to-date.

3.5. BACK UP YOUR DATA

With **Backup**, you can securely store your personal data, including Google Calendar settings, Google contacts, Chrome browser data, and Gmail settings, along with selected system settings, in your Google Account. This ensures that your information is backed up to the cloud via a network connection. This allows you to easily restore the settings on this device after a Factory Reset (refer to [Reset to Factory Default](#)). Follow the steps to start your backup settings:

1) Ensure your device is connected to the network.

2) Go to [App Drawer](#) | **Settings**  | **Google**  | **Backup** 

OR

[App Drawer](#) | **Settings**  | **Google**  | **Backup**  and enable **Back up to Google Drive**.

3) To restore your back-up personal data from your Google Account, tap on **"Add Account"** to sign in with your Google Account and add it to the device.

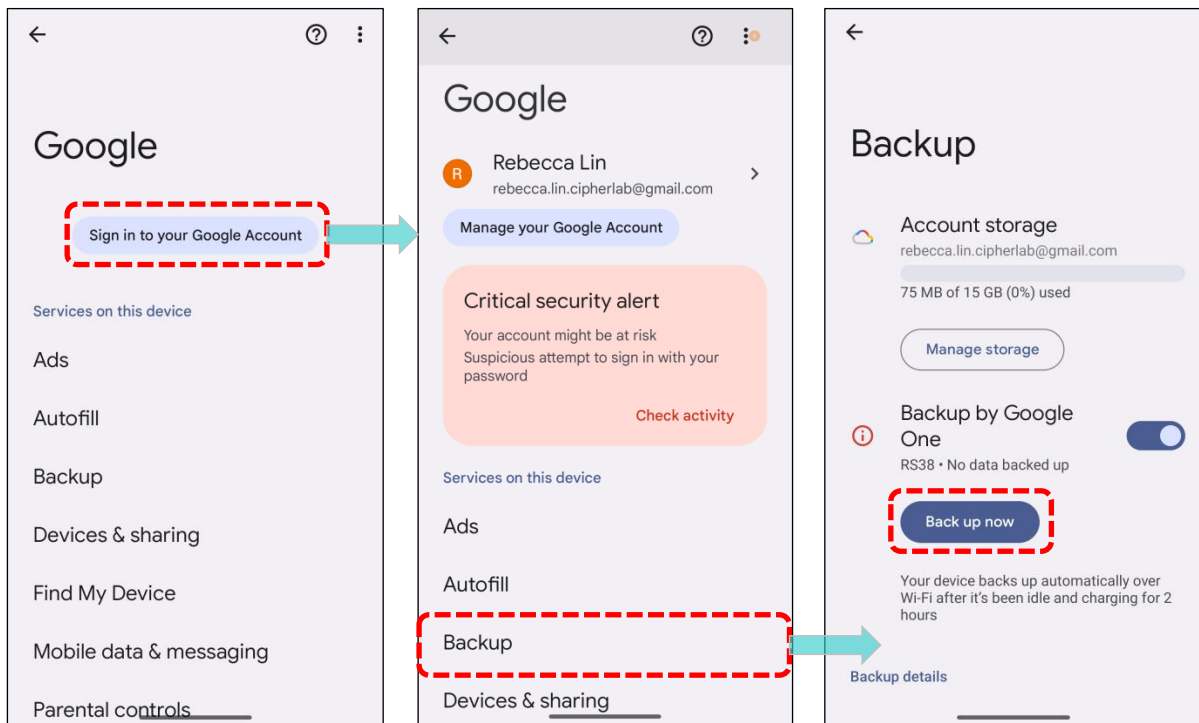

Note:

- (1) To back up your photos and videos, open Photos  from the [App Drawer](#) and log in to your Google Account to sync the files on your device with Google Photo Library.

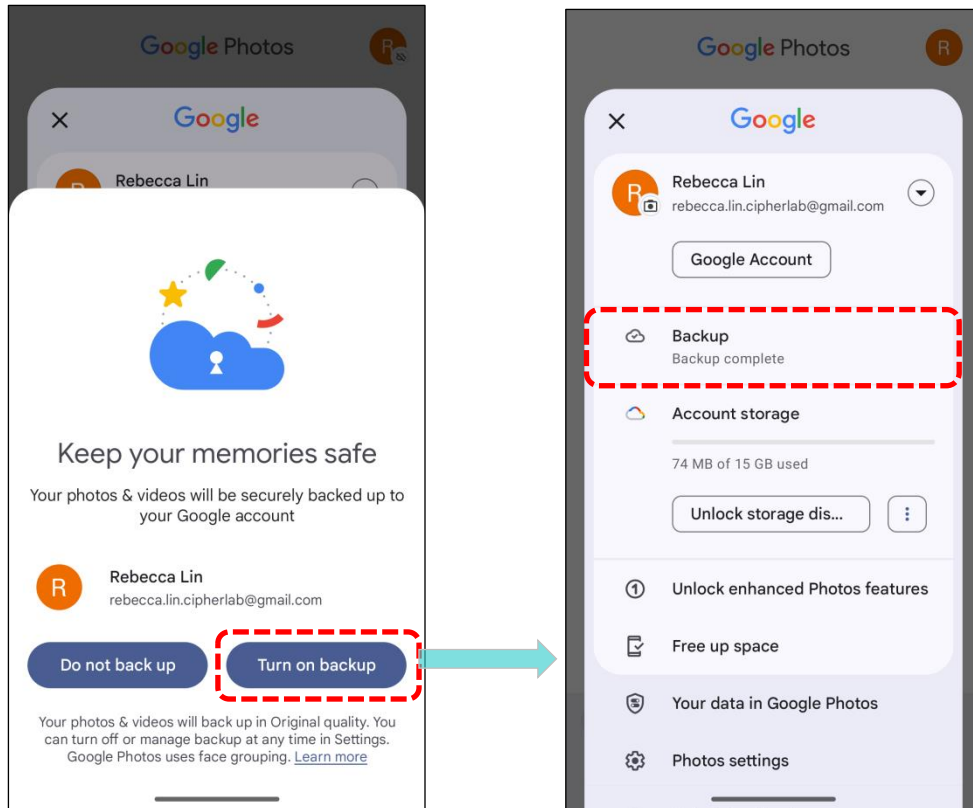

- (2) To back up other data such as audio or video files stored on the device, utilize the Google Drive service.
- (3) Backup may not handle certain app progress data and settings.
-

3.6. RESET TO FACTORY DEFAULT

Performing a factory reset will erase all data on your mobile computer, including files, installed apps, and their associated data, reverting the device to its original state as if it were powered on for the first time.



It is strongly recommended to follow the instructions in "[Back Up Your Data](#)" to back up important data before performing a factory reset.

When configuring your RS38 mobile computer using **ADC (Android Deployment Configurator)**, the settings will automatically back up to the "**enterprise partition**" of your RS38 mobile computer. The settings saved in the enterprise partition will not be erased by proceeding with "**Erase all data (factory reset)**". To erase all settings, please select "**Erase all data (factory reset with enterprise)**".

3.6.1. ERASE ALL DATA (FACTORY RESET)

"**Erase all data (factory reset)**" will erase all the data except for the settings backed up in enterprise partition by ADC (Android Deployment Configurator).

To start:

- 1) Go to [App Drawer \(All Apps\)](#) | **Settings**  | **System**  .
- 2) Tap on Reset options  and Erase all data (factory reset).

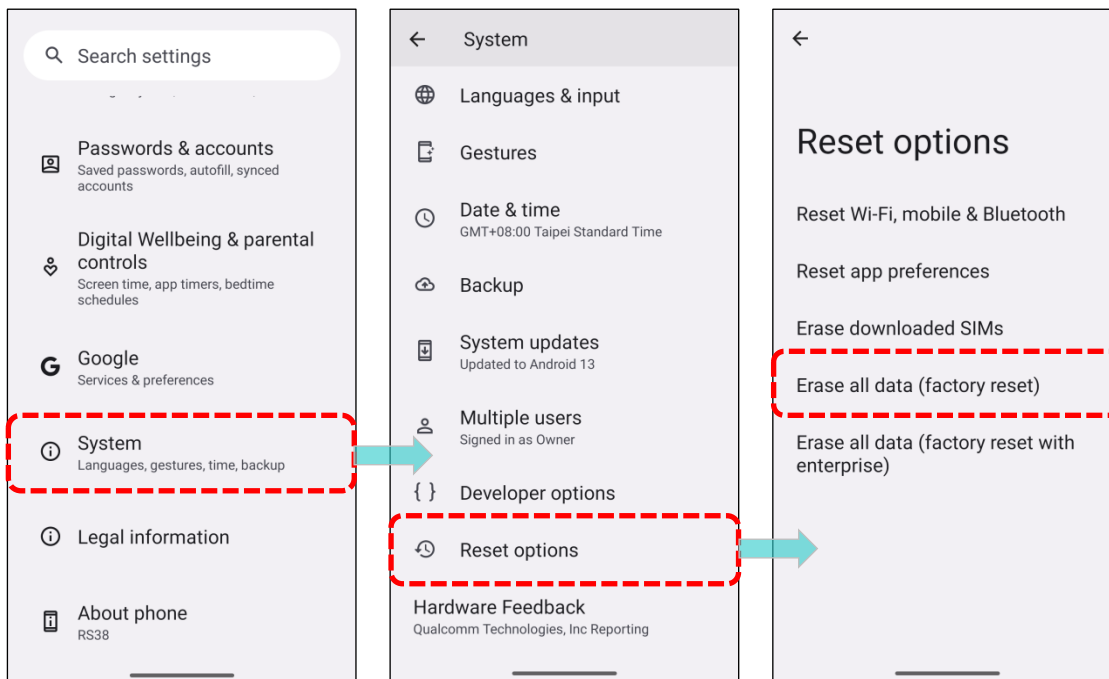

- 3) Confirm the action by tapping on “**Erase all data**” and enter the verification code (Please contact with support@cipherlab.com.tw to obtain your verification code). Finally, tap “**OK**” to initiate the factory reset.

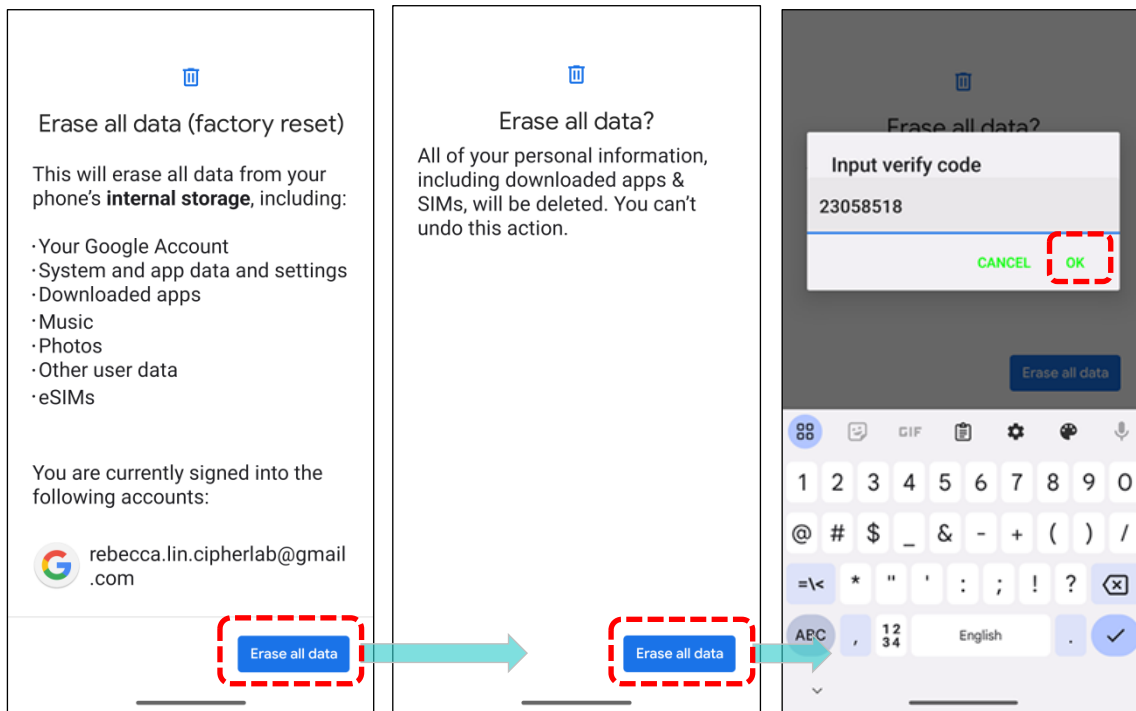

3.6.2. ERASE ALL DATE (FACTORY RESET WITH ENTERPRISE)

Go to [App Drawer \(All Apps\)](#) | **Settings**  | **System**  | **Reset options**  | **Erase all data (factory reset with enterprise).**

Confirm the action by tapping on “**Erase all data**”, then enter the verification code (Please contact with support@cipherlab.com.tw to obtain your verification code), and tap “**OK**” to initiate the enterprise reset.

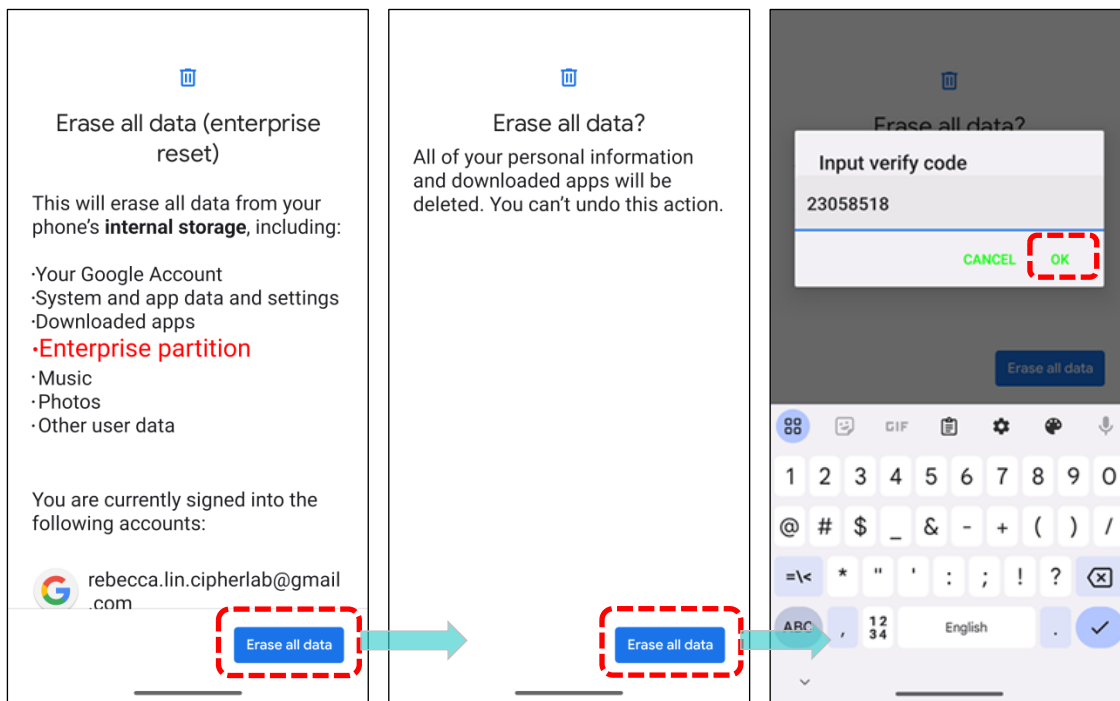

Please note that “**Erase all data (factory reset with enterprise)**” will erase all the data, including the settings backed up in the enterprise partition by **ADC (Android Deployment Configurator)**.

3.6.3. WELCOME WIZARD

Upon booting up the mobile computer for the first time after the reset, the **Welcome Wizard** will guide you through setting up the environment and restoring apps and data. During setup, you can tap **“SKIP”** to proceed to the next step, completing the respective settings later in the **App Drawer | Settings**



Please note that to restore the backed-up data from your Google Account at this stage, ensure to log in to a Wi-Fi network when prompted to **Connect to Wi-Fi**.

- Step 1

Tap on **“START”** to proceed, or tap to enter **“Choose your language”** / **“Vision Settings”**.

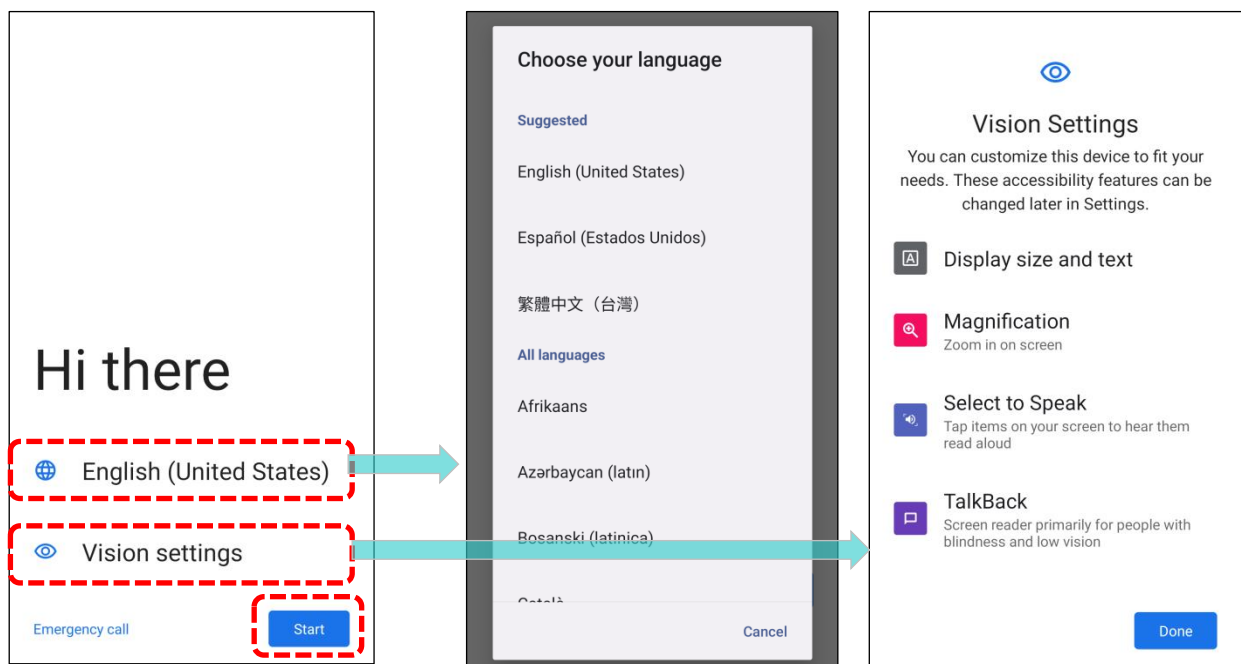

- Step 2

To complete the deployment of the device through the QR code generated by ADC (Android Deployment Configurator) or ReMoCloud, **tap the blank space** on the screen **six times** to access the scanning page.

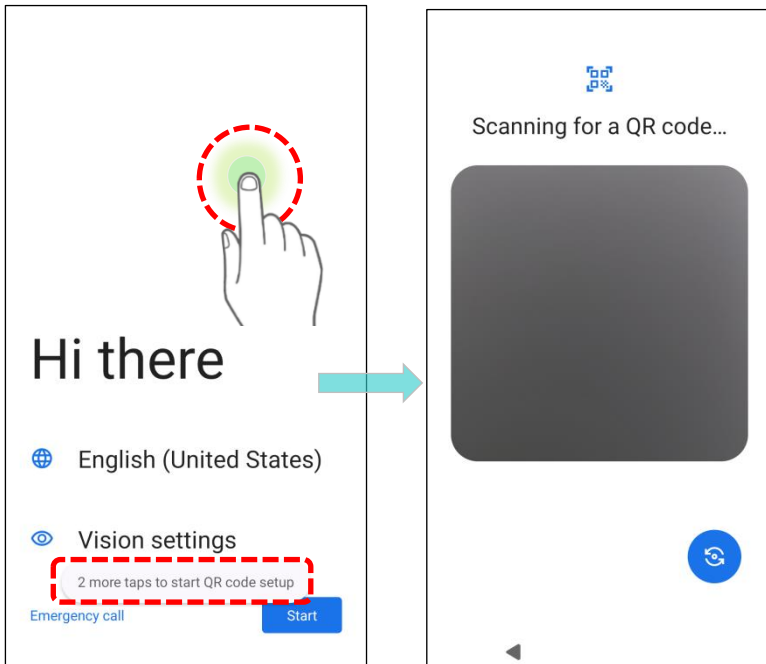

- Step 3

Aim the device's camera at the QR code, and tap **"Next"** to confirm that the device will be managed as a work device.

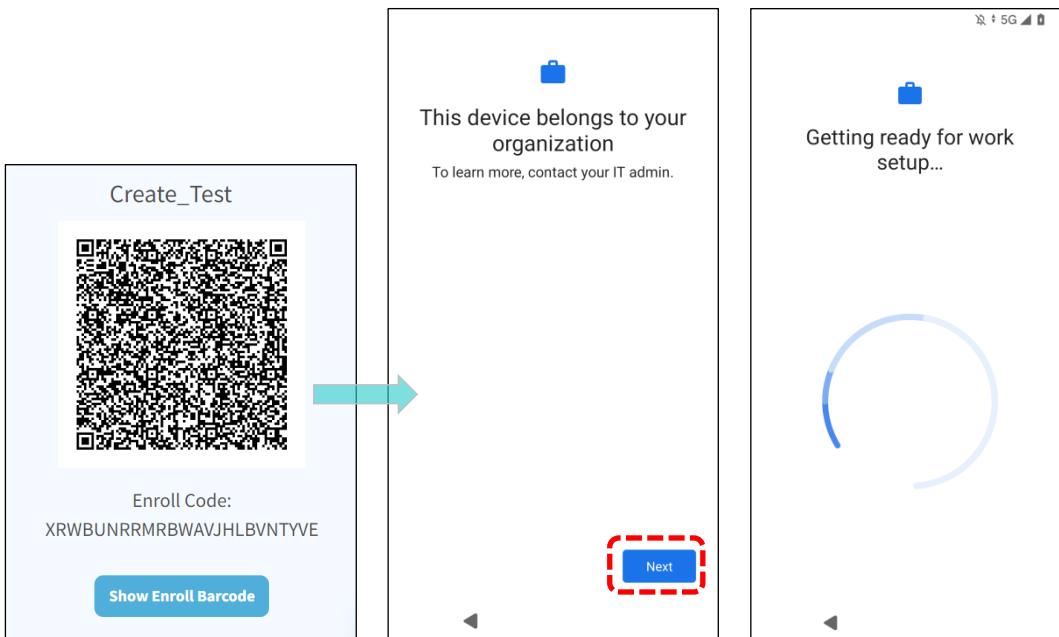

- Step 4

Tap **"Accept & Continue"** to proceed.

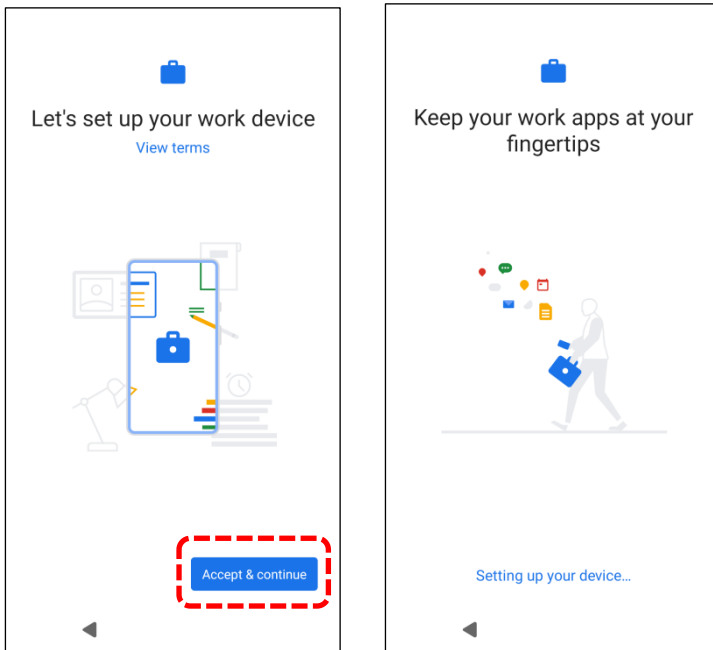

- Step 5

Insert your SIM to connect to mobile network, or tap on **"SKIP"** to the next st

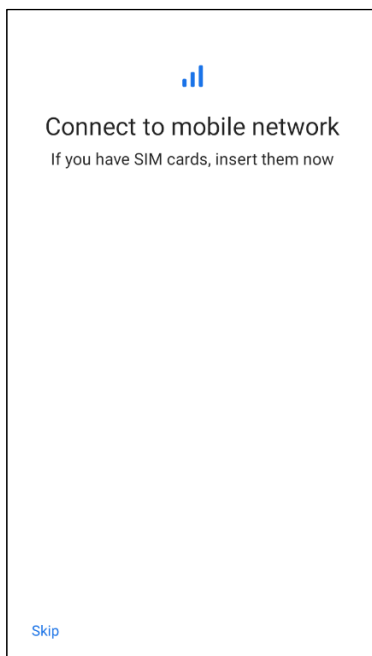

If not enrolling the device through ADC or ReMoCloud, tap **"Start"**.

Choose a Wi-Fi network or to tap on **"Set up offline"** , then confirm with **"CONTINUE"** to the next step.

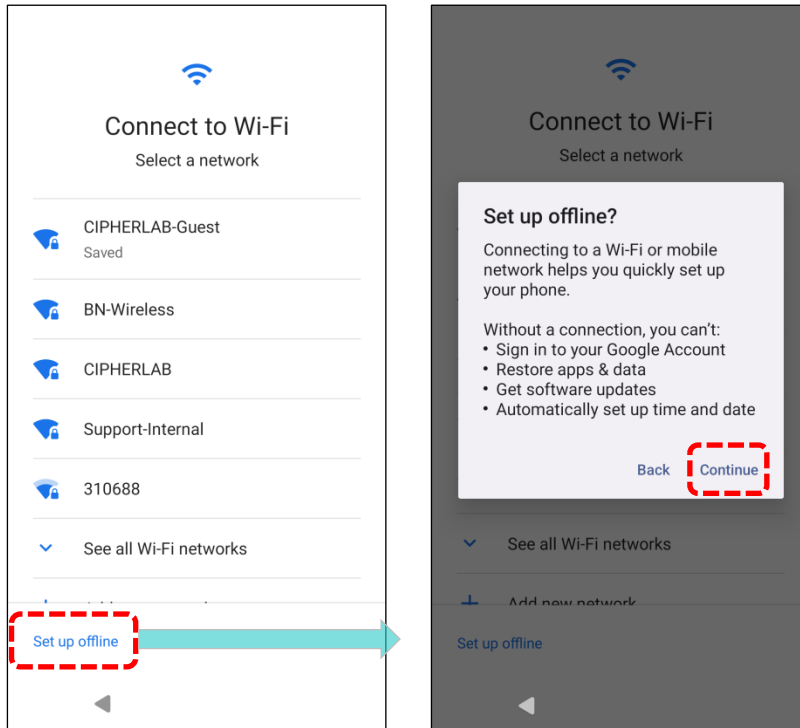

▪ Step 6

Choose Google services that you want to be enabled, and tap **"ACCEPT"** to proceed.

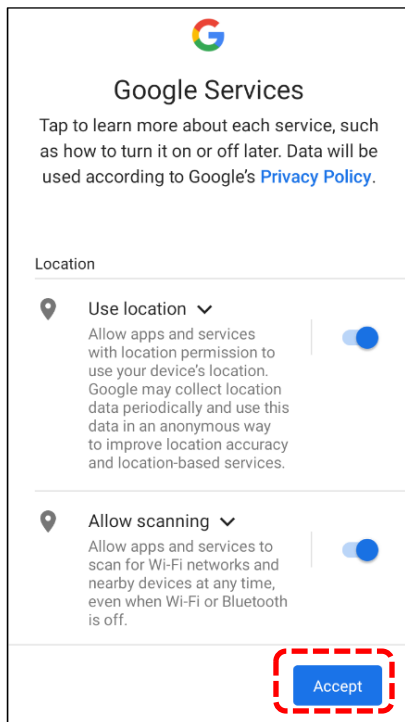

▪ **Step 7**

Set up the protection methods to protect this device, or merely **“SKIP”** this step.

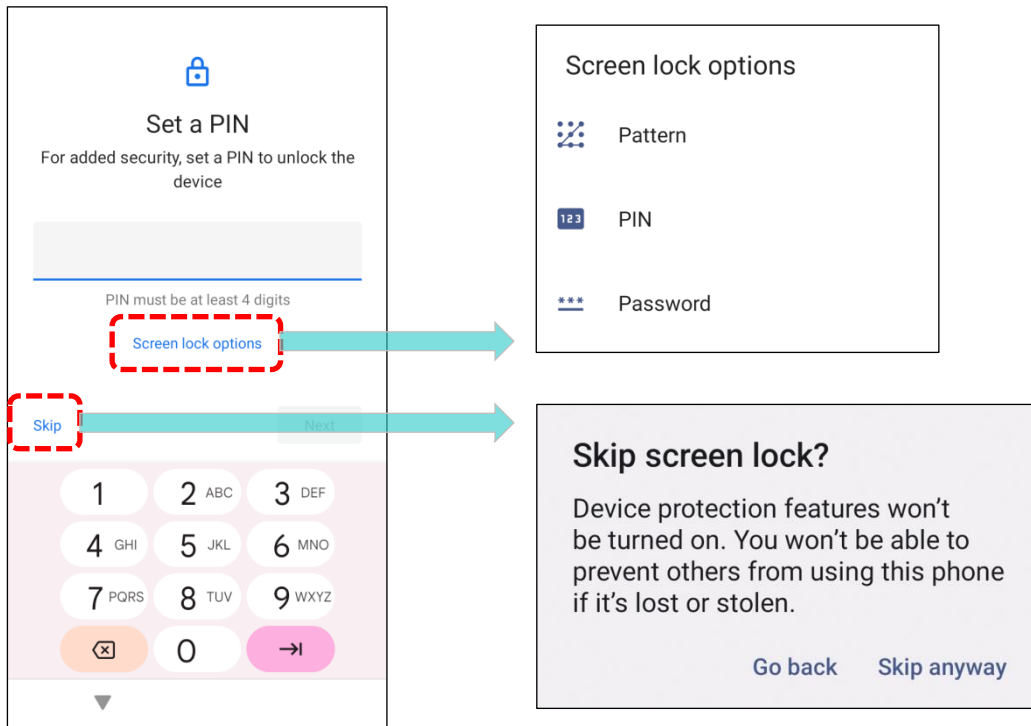

▪ **Step 8**

It takes few seconds to complete the settings.

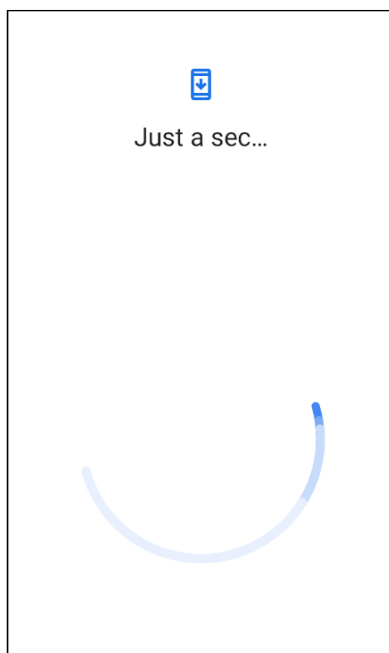

Once the initial setup is completed, the **Home** app screen shows up. Apps and settings will be restored in the background.

Chapter 4

CHAPTER 4. WIRELESS RADIOS

This chapter will guide you through the configuration and establishment of wireless network connections using the integrated Wi-Fi module of the RS38 mobile computer.

IN THIS CHAPTER

| | |
|--|-----|
| 4.1. Use Wireless Local Area Network (Wi-Fi) | 132 |
| 4.2. Use Bluetooth | 144 |
| 4.3. Use Near Field Communications..... | 153 |

4.1. USE WIRELESS LOCAL AREA NETWORK (WI-FI)

4.1.1. CONNECT TO WI-FI NETWORK

To power on Wi-Fi:

- 1) Go to [App Drawer](#) | **Settings**  | **Network & Internet**  | **Internet**.

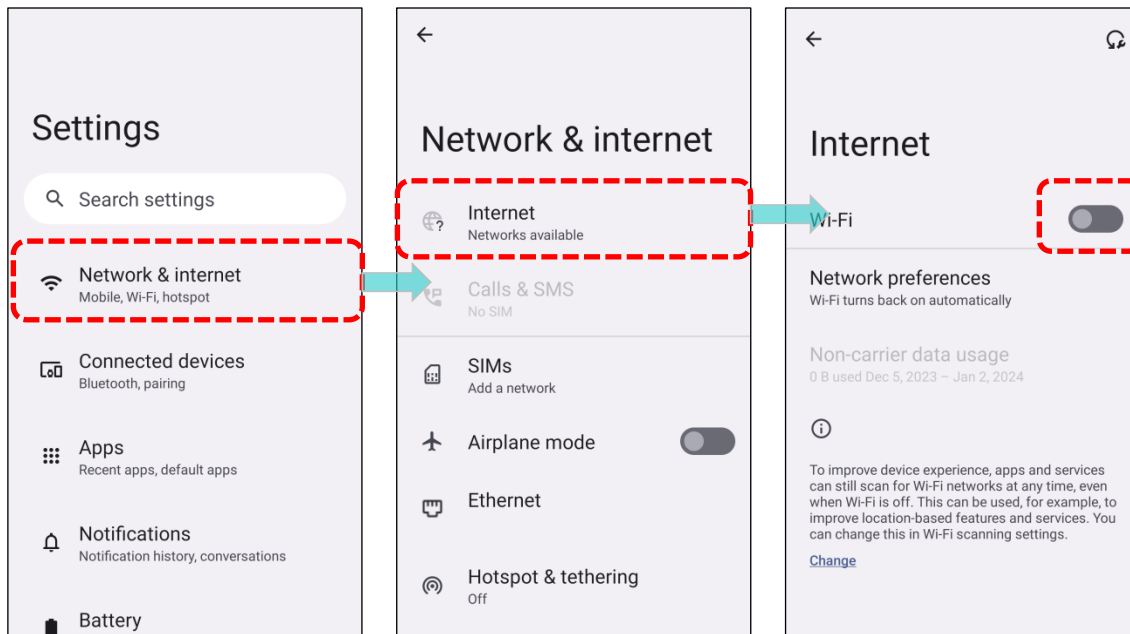

- 2) Tap the Wi-Fi switch to scan for available networks.

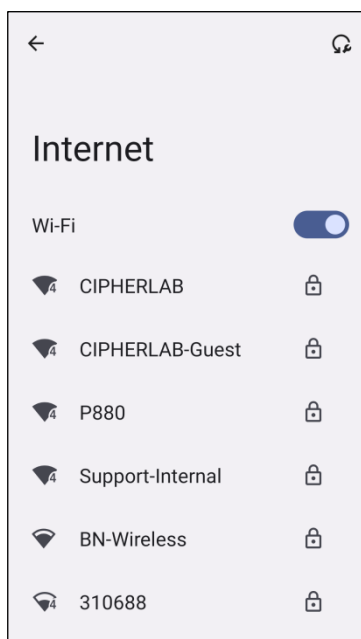

- 3) Select a network to connect.

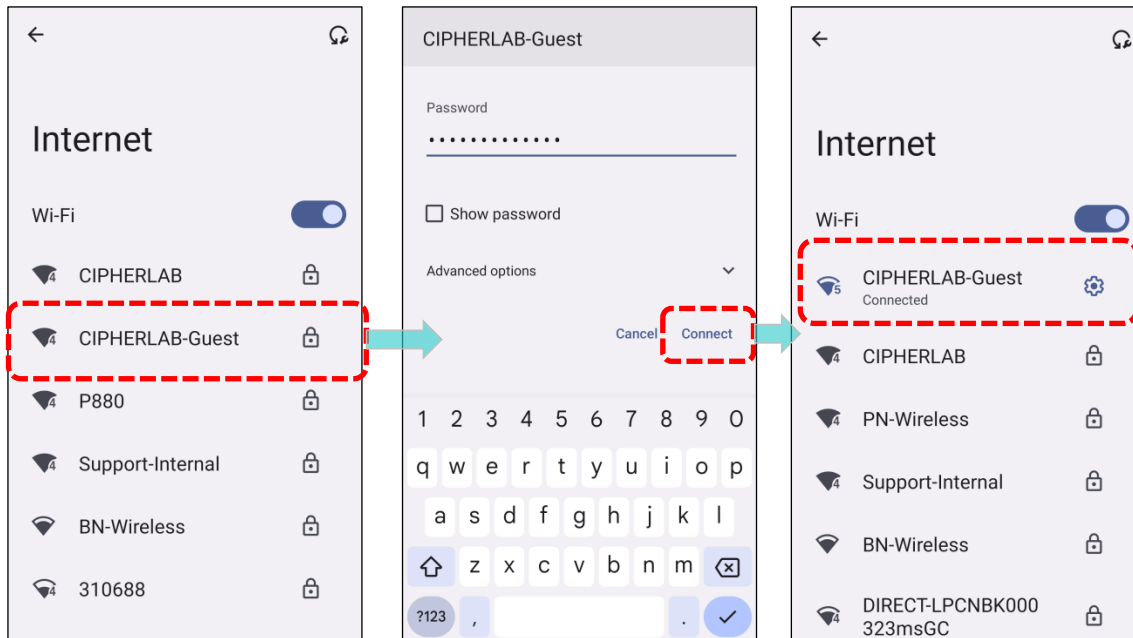

If the network is an open one, the mobile computer will attempt to connect to it directly. Once connected, the status will change to **“Connected”**.

If the network is a secured one, the mobile computer will prompt a dialog to enter the password for the connection.



4.1.2. MANUALLY ADD WI-FI NETWORK

If the network you would like to connect to does not broadcast its SSID, or if the network is out of range, you may add it manually.

- 1) Go to [App Drawer](#) | **Settings**  | **Network & internet** .
- 2) Tap the Wi-Fi switch to turn it on.

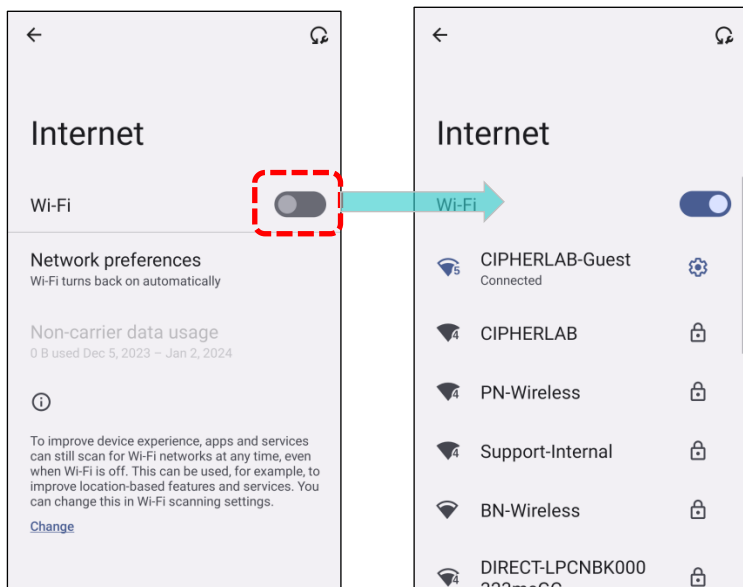

- 3) Scroll down to the bottom of the page, and select **"Add network"**.
- 4) On **"Add network"** page, enter the name of the network in the **"Network name"** field, and select a security method.

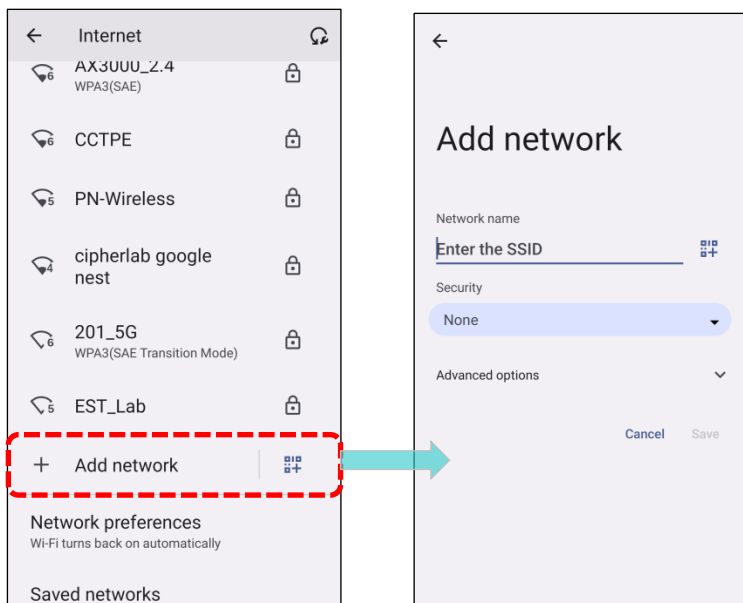

- **“Enhanced Open”** is for public networks and provides no authentication.
- For **WEP, WPA/WPA2-Personal, and WPA3-Personal** connections:
Enter the required password and tap **“Save”**.
- For **“WPA/WPA2/WPA3-Enterprise”** connections, choose the **EAP method** (PEAP, TLS, TTLS, PWD, SIM, AKA, AKA'), and the **Phase 2 authentication** (MSCHAPV2, GTC, SIM, AKA, AKA'). Select a **CA certificate** and **User certificate** if required.

Enter your username in the Identity box and the password in the Password box if required.

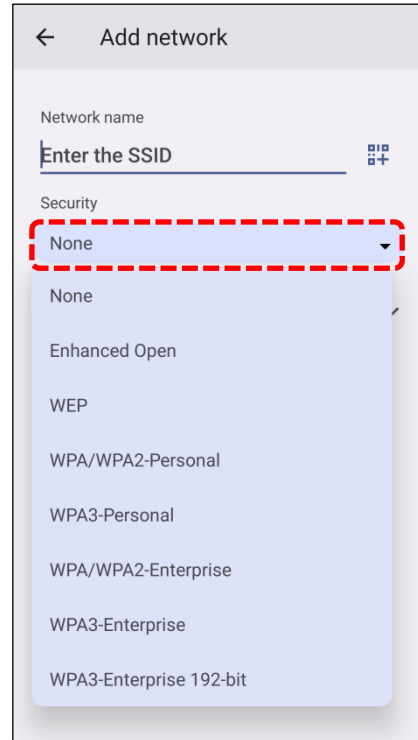

Note:

Certificates may be installed under:

[App Drawer](#) | [Settings](#)  | [Network & internet](#)  | [Internet](#) | [Network preferences](#) | [Install certificates](#).

The mobile computer supports the following certificate file extensions:

| File Extension Type | Standard Certificate | Key Stored |
|---------------------|---|--|
| Description | DER-encoded X.509 certificates saved in .crt or .cer files. | X.509 certificates saved in PKCS#12 key store files with a .p12 or .pfx extension. |
| How to install | change the extension to .crt or .cer. | Change the extension to .p12 or .pfx. |

- 5) For **advanced options**, select the **Proxy** server and **IPv4** settings if necessary. By default, no proxy is set, and IP settings are configured for **DHCP**.

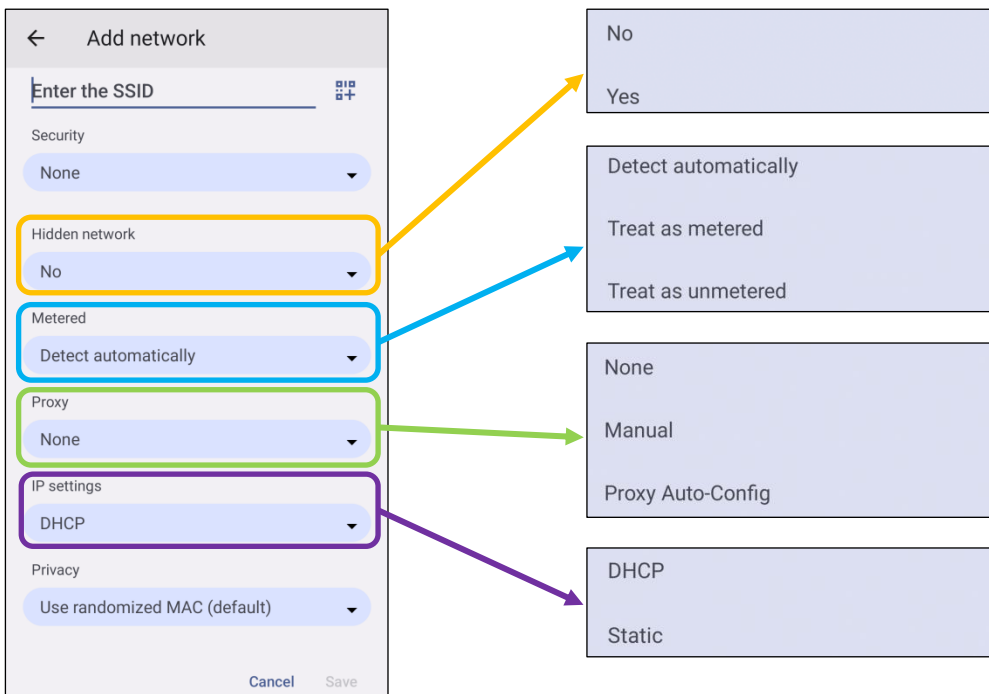
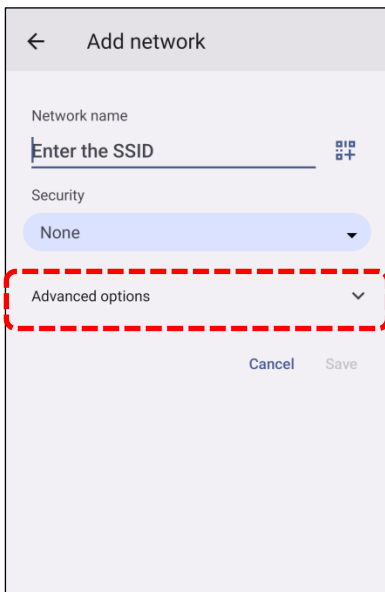

4.1.3. WI-FI PREFERENCE

To access **Network Preferences**:

- 1) Go to [App Drawer \(All Apps\)](#) | Settings  | Network & internet  | Internet

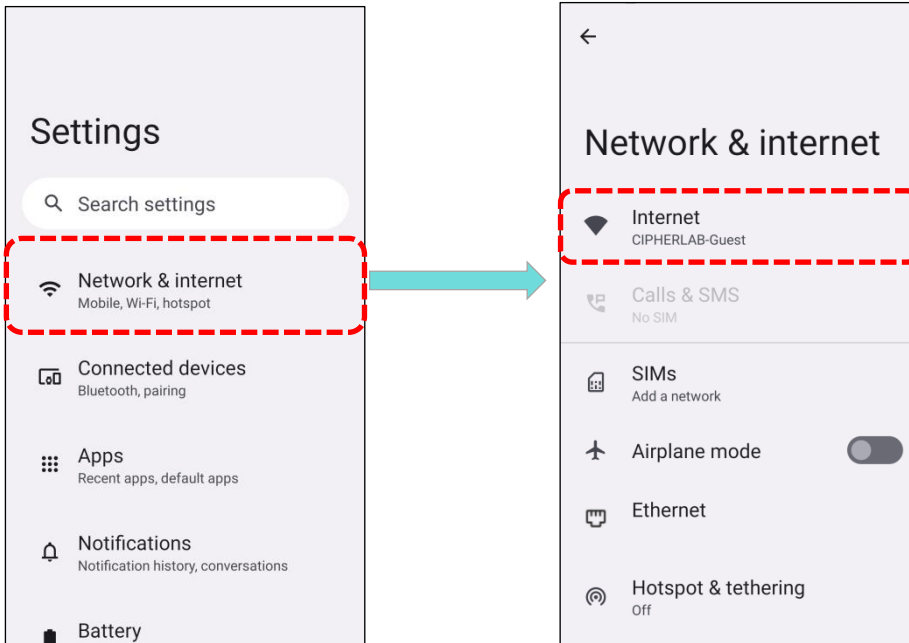

- 2) Scroll down to the bottom of the page to enter "**Network preferences**".

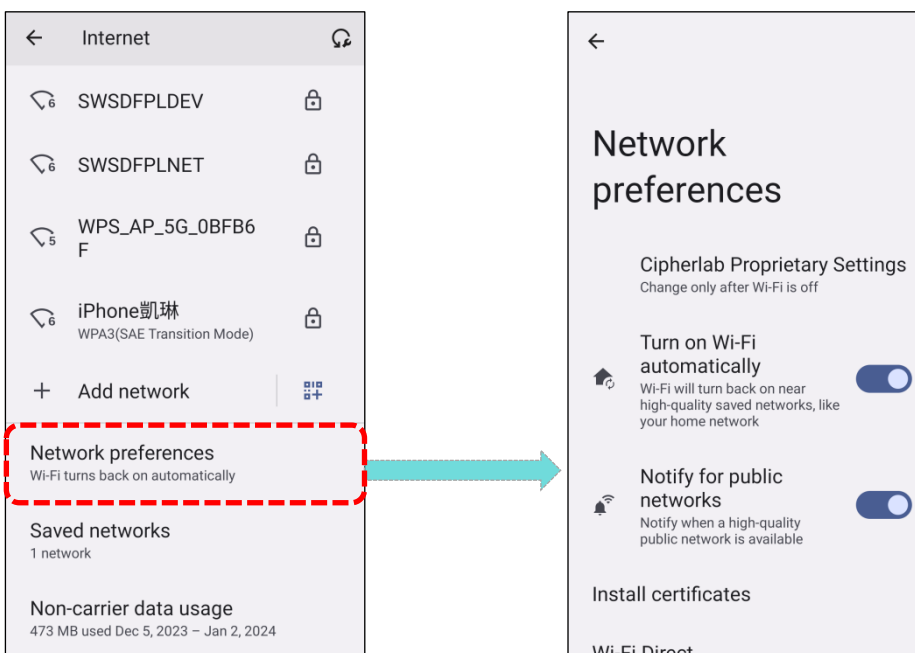

The available settings are as bellow:

| Item | Description |
|--------------------------------|---|
| Cipherlab Proprietary Settings | Tap to enter the page for further settings. Please refer to Cipherlab Proprietary Settings for details. |
| Turn on Wi-Fi automatically | Even you've turned off Wi-Fi, the device will automatically turn on your Wi-Fi connection when there's the saved network with a strong signal nearby. |
| Notify for public networks | Notify when a high-quality open network is available. |
| Install certificates | Installs certificates recently downloaded or placed on the internal storage. |
| Wi-Fi Direct | Enables your device to connect with a Wi-Fi Direct-capable device. |

CIPHERLAB PROPRIETARY SETTINGS

To configure the grayed out options listed on **"Cipherlab Proprietary Settings"**, Wi-Fi must be turned off. Turn on Wi-Fi again to apply the settings once the configuration is done.

- 1) Turn off Wi-Fi, then tap on **"Network Preferences"** and select **"Cipherlab Proprietary Settings"**.
- 2) Configure the settings under Cipherlab Proprietary Settings.

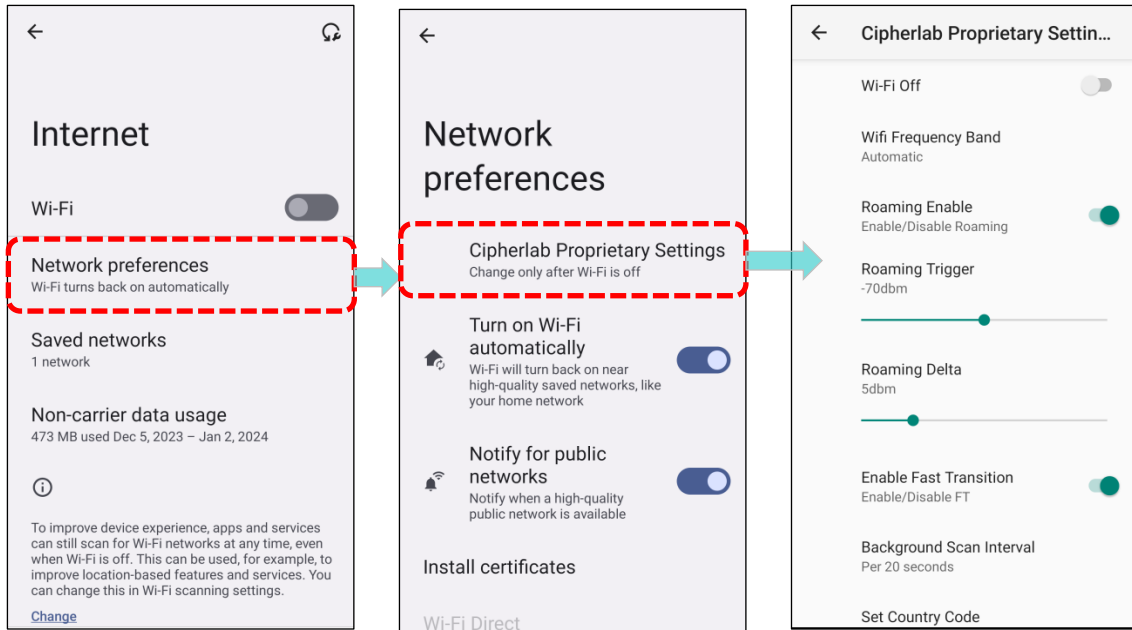

- 3) After completing the settings, turn on Wi-Fi to apply the changes.

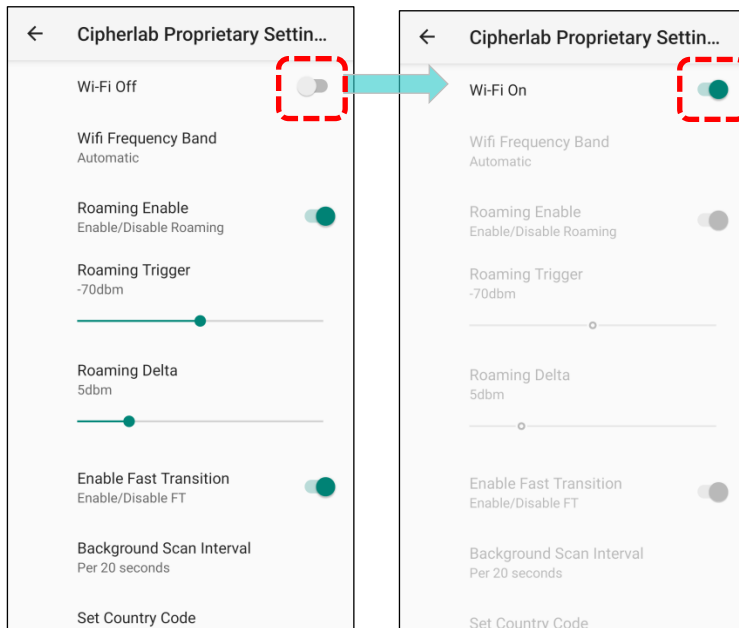

| Item | Description |
|------|-------------|
|------|-------------|

| | |
|--------------------------|--|
| Wifi Frequency Band | Select Automatic, 6 GHz only, 5 GHz only, or 2.4 GHz only for your Wi-Fi frequency band. The default setting is Automatic. |
| Roaming Enable | Choose whether to enable or disable Wi-Fi roaming. |
| Roaming Trigger | The signal strength determines when Wi-Fi roaming is triggered. A higher value indicates increased sensitivity to trigger roaming. |
| Roaming Delta | The qualification for roam candidates. A higher value implies that the signal strength of candidate Access Points (APs) should surpass that of the currently connected AP. |
| Enable Fast Transition | Enable 802.11r Fast Transition feature. |
| Background Scan Interval | The frequency of background scans occurs when the device is not connected to the internet. A shorter time implies a higher scanning frequency. |
| Set Country Code | Select the Wi-Fi country code for your device. |
| Enable WLAN Blacklist | Tap to block specified Wi-Fi networks from connecting to the device. |
| Wi-Fi Connection Timeout | Enable the function to set the duration for attempting to connect to a Wi-Fi network before timing out. |
| Captive Portal Detection | Automatically identifies and prompts users to log in to public Wi-Fi networks that require authentication. |
| Ip Reachability Monitor | Tap to enable the monitor to check legality of IP address. |
| Channel Selection | Select the most suitable frequency channel for optimal performance. |
| Reset to Default | Reset all settings to default. |

Note: Cipherlab Proprietary Settings cannot be configured while Wi-Fi is turned on.

4.1.4. MODIFY WI-FI NETWORK

MODIFY THE CONNECTED NETWORK

To change the settings for a connected network:

- 1) Tap a connected network in the Wi-Fi hotspot list to enter its **"Network details"** page.

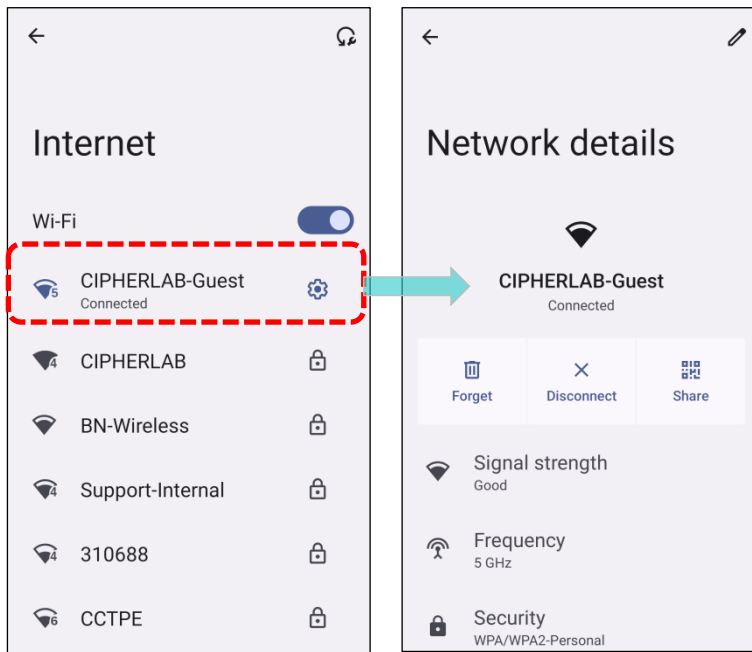

- 2) Tap **"Edit"**  to open the pop-up menu.
- 3) Modify the network settings, and tap **"Save"**.

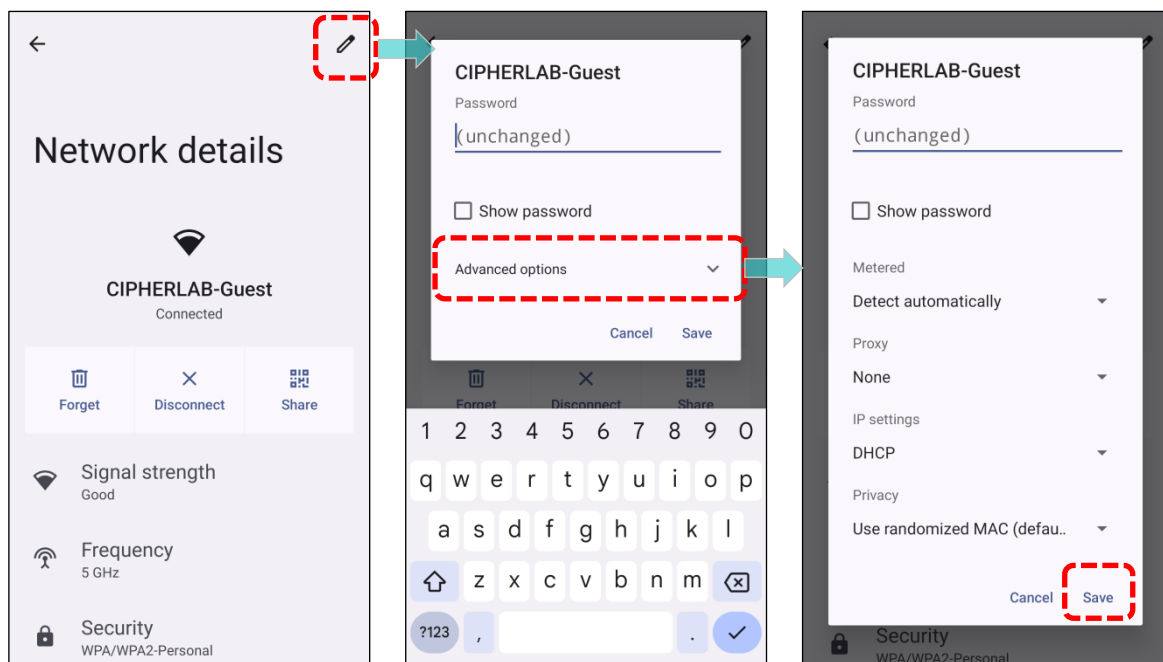

MODIFY THE SAVED NETWORK

To change the settings for a saved network:

- 1) Tap and hold a saved network in the Wi-Fi hotspot list.
- 2) Tap **"Modify"** in the pop-up menu.
- 3) In the dialog box that opens, modify the network settings, and tap **"Save"**.

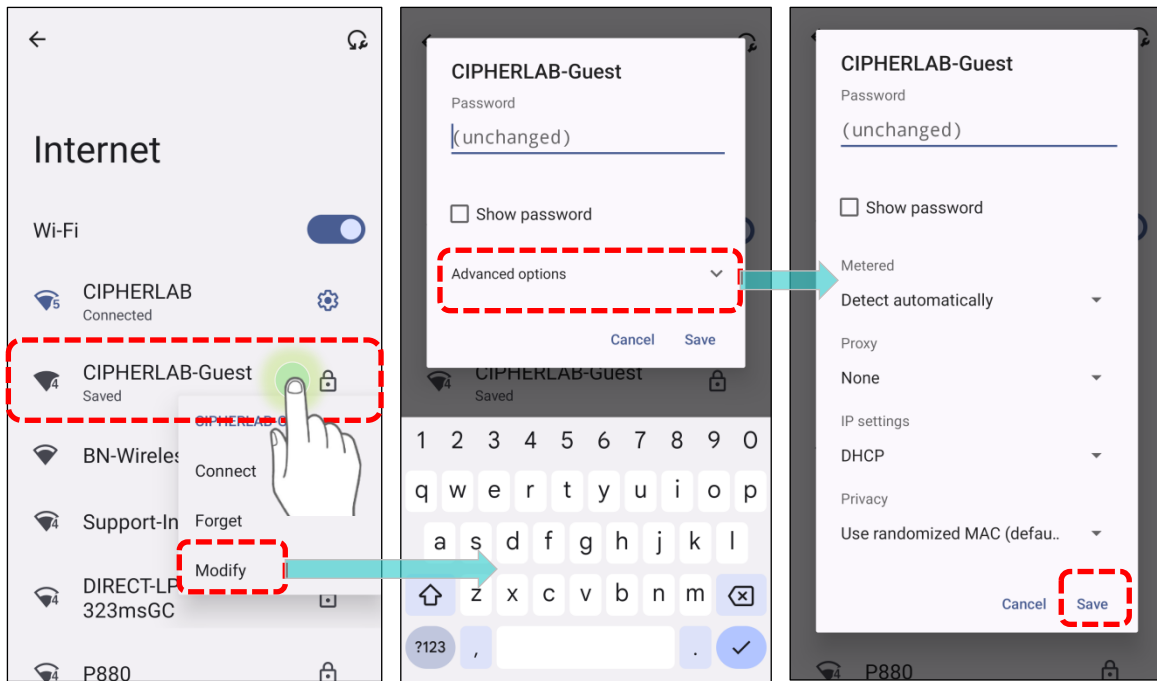

4.1.5. DISCONNECT WI-FI NETWORK

To disconnect a connected network:

- 1) Tap a connected network in the Wi-Fi hotspot list to enter its **"Network details"** page.
- 2) Tap **"DISCONNECT"**.

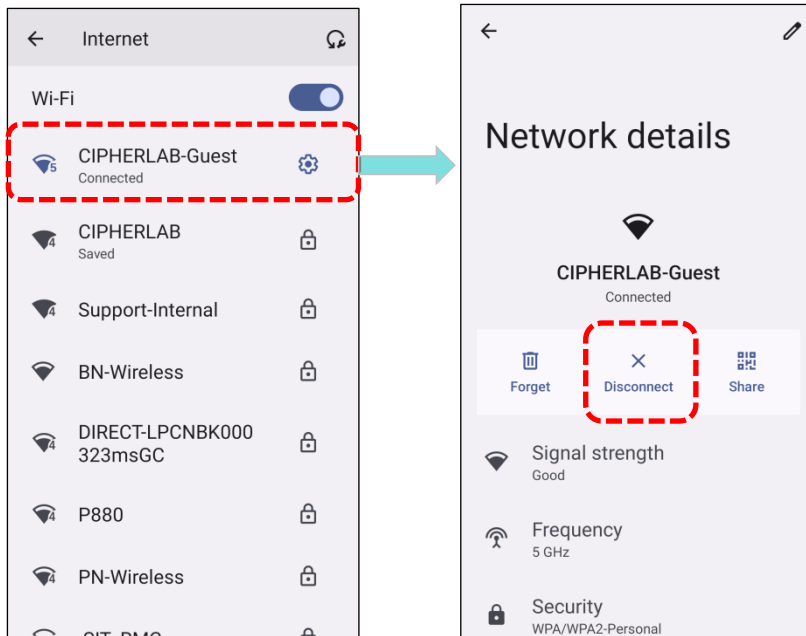

To forget a **saved network**:

- 1) Tap and hold a saved network in the Wi-Fi hotspot list.
- 2) Tap **"Forget"** in the pop-up menu.

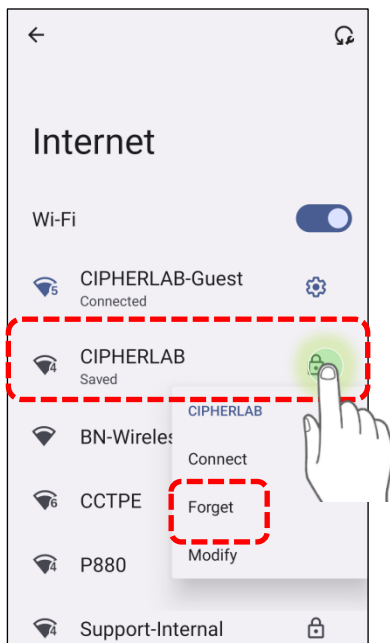

4.2. USE BLUETOOTH

The RS38 mobile computer allows you to configure Bluetooth settings and manage Bluetooth services provided on remote devices.

4.2.1. BLUETOOTH PROFILES

Bluetooth Profiles Supported

| | | |
|-------------------------------------|--------------|---|
| Generic Access Profile | (GAP) | For device discovery and authentication. |
| Service Discovery Access Profile | (SDAP) | Discovers services on remote devices. |
| Headset Profile | (HSP) | Describes how a Bluetooth enabled headset should communicate with a Bluetooth enabled device. |
| Serial Port Profile | (SPP) | Sets up a virtual serial port to connect two Bluetooth devices. |
| Human Interface Device Profile | (HID) | Provides a low latency Bluetooth connection with keyboards, pointing devices, etc. |
| Object Push Profile | (OPP) | Pushes and pulls objects to and from a push server. |
| Hands-Free Profile (AG1.5) | (HFP) | Allows using a hands-free device to place and receive calls. |
| Hands-Free Profile | (HFP 1.6) | Allows using a hands-free device to place and receive calls. |
| Advanced Audio Distribution Profile | (A2DP) | Streams stereo-quality audio to a wireless headset or speaker. |
| Audio/Video Remote Control Profile | (AVRCP) | Allows controlling of television and Hi-Fi equipment. |
| Generic Object Exchange Profile | (GOEP) | Provides a basis for other data profiles. |
| Personal Area Networking Profile | (PAN) | Uses Bluetooth Network Encapsulation Protocol for Bluetooth transmission. |



Bluetooth Profiles Supported

| | | | |
|---------------------------------|--------------------------|------------|---|
| General Profile | Audio/Video Distribution | (GAVDP) | Provides a basis for A2DP and VDP. |
| Phone Book Access Profile | | (PBAP) | Transfers Phone Book Objects to a car kit to display the information of an incoming call received on the mobile computer, or initiate a call. |
| Out of band and Communications | Near Field | (OOB, NFC) | Manages the pairing process by using NFC. |
| Symbol Serial Interface Profile | | (SSI) | Supports additional scanner. |
| Dial-up Networking Profile | | (DUN) | Provides a standard to access the Internet and other dial-up services over Bluetooth. |
| HID over GATT Profile | | (HOGP) | Defines the communication between a BLE (Bluetooth Low Energy) device and a host device. |
| Generic Attribute Profile | | (GATT) | Defines how BLE (Bluetooth Low Energy) devices transfers data. |

4.2.2. TURN ON BLUETOOTH

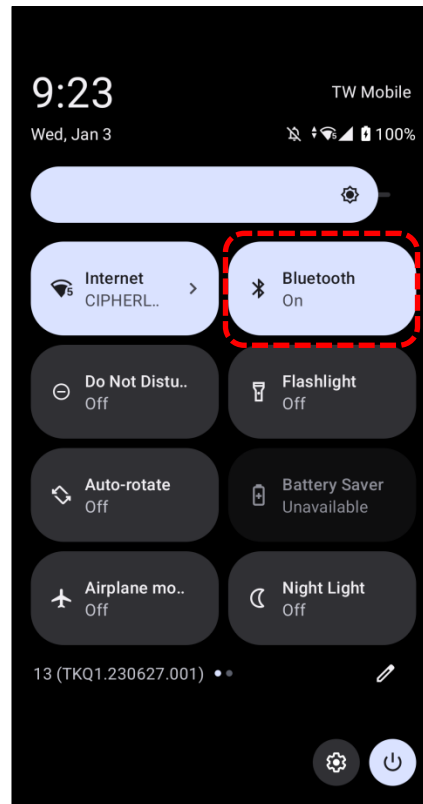
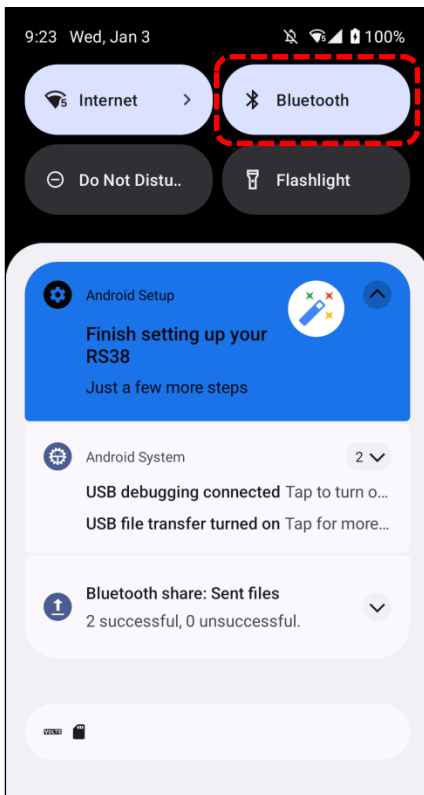
Bluetooth is turned off by default, and you can turn it on or off by tapping the Bluetooth icon on **Quick Settings Menu** or **Quick Settings Panel**:





| Icon | Description |
|---|---------------------------|
|  | Bluetooth is OFF . |
|  | Bluetooth is ON . |

To enter “**Connected devices**” page for further Bluetooth settings, please long press the Bluetooth icon

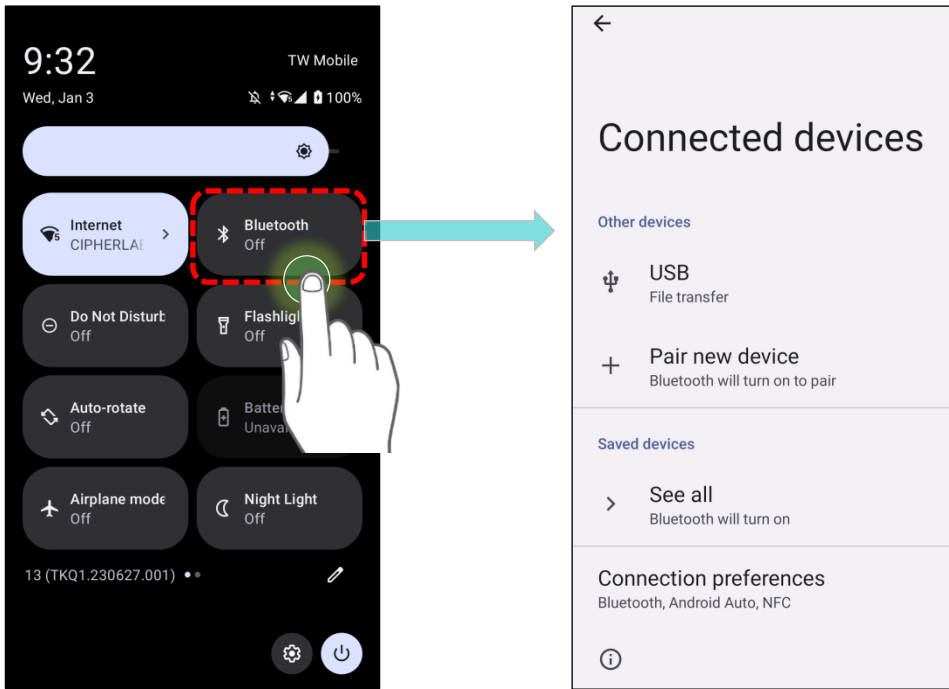
 on **Quick Settings Menu** or **Quick Settings Panel**:



1) Alternatively, go to [App Drawer \(All Application\)](#) | **Settings**  | **Connected devices**  | **Connection preferences** | **Bluetooth** .

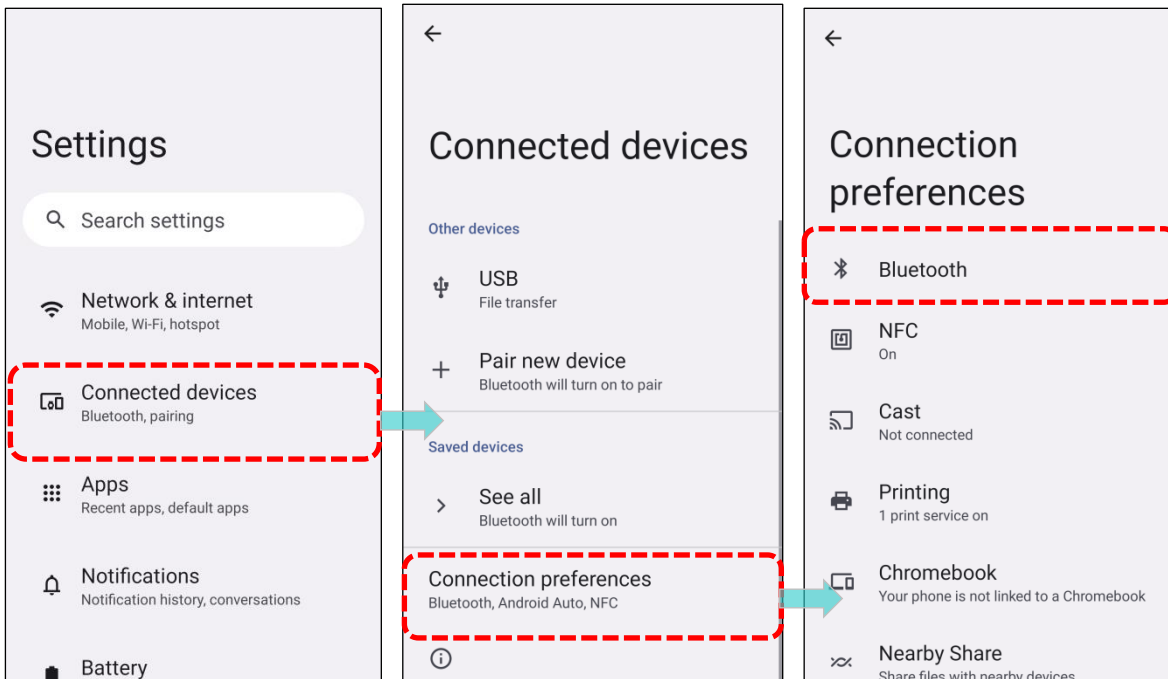

2) Tap the switch to turn on this function while enabling the Bluetooth visibility of this device.

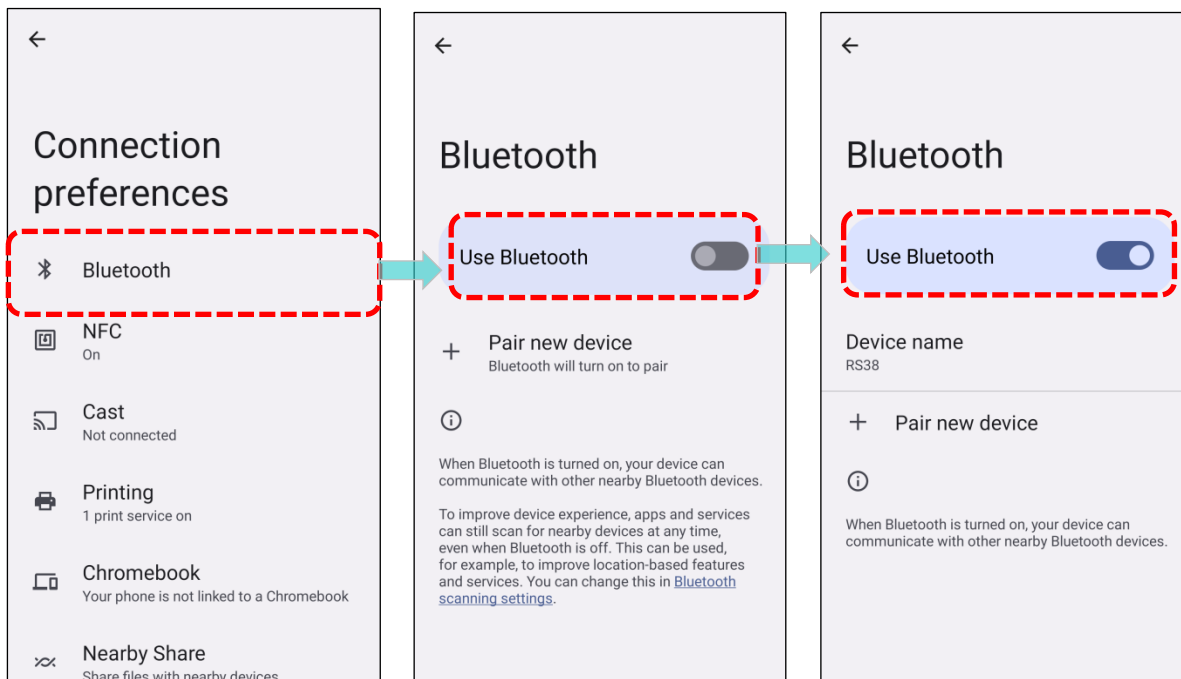



Note:

When turned on, Bluetooth remains active even during suspension on the mobile computer. However, activating Airplane Mode will disable Bluetooth power, overriding any previous settings.



4.2.3. CHANGE BLUETOOTH NAME

To change the Bluetooth name of this mobile computer:

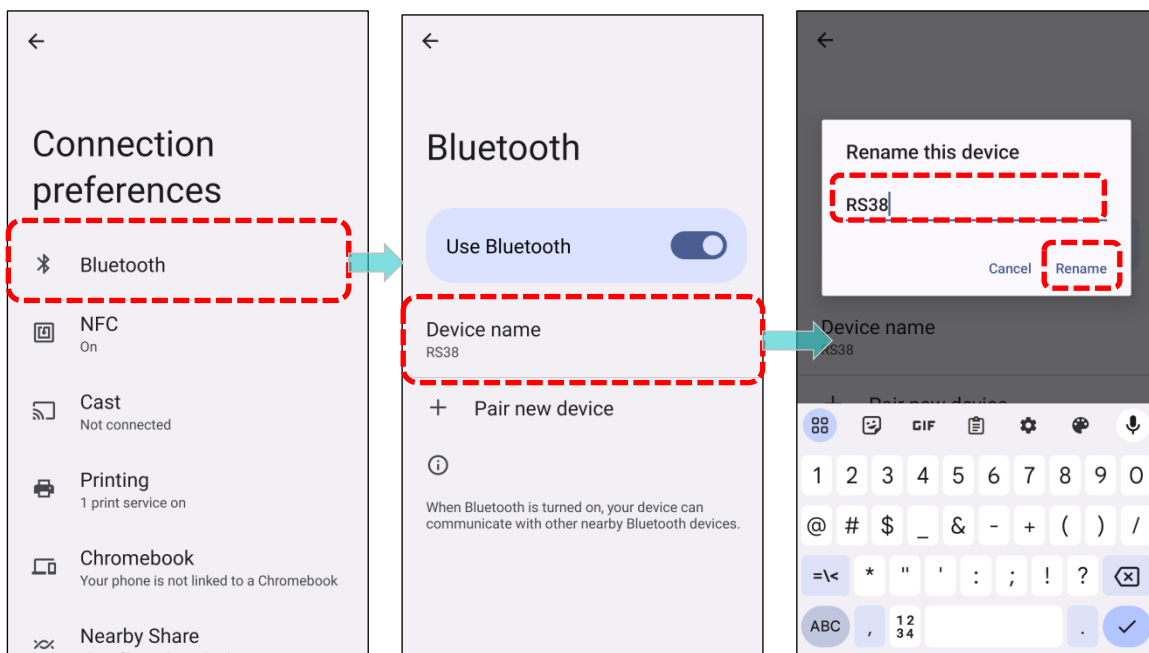
- 1) Go to [App Drawer \(All Application\)](#) | **Settings**  | **Connected devices**  | **Connection preferences** | **Bluetooth** .
- 2) Tap on **"Device name,"** and a pop-up window titled **"Rename this device"** will appear.
- 3) Type a new name in the field and tap **"RENAME"** to complete the change.



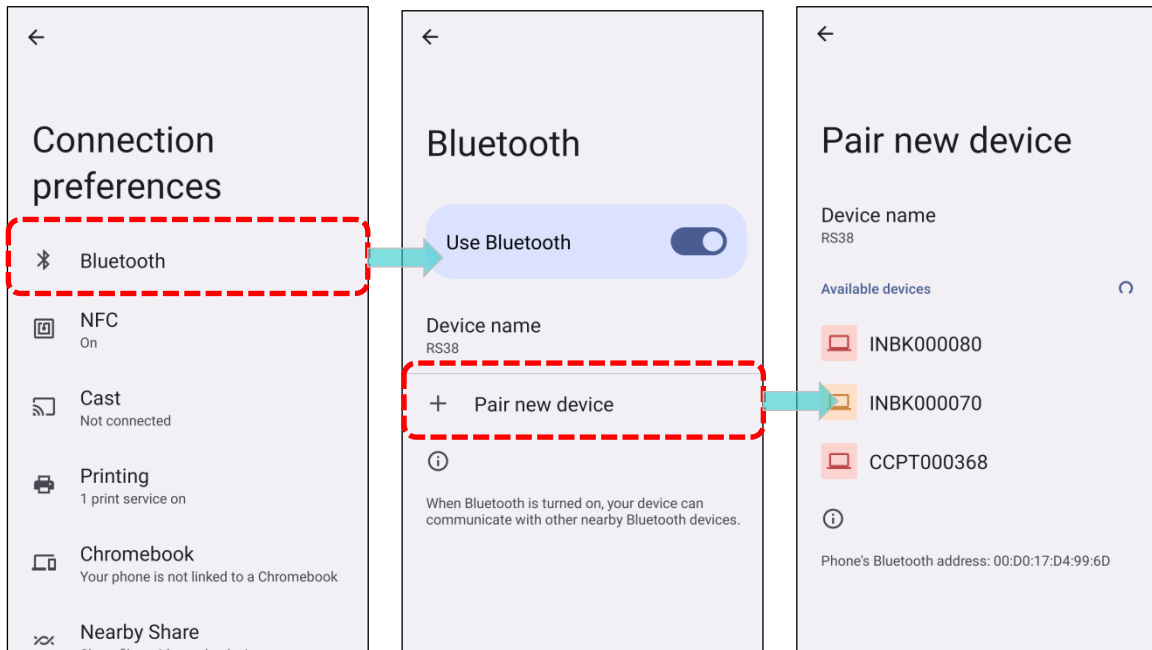

4.2.4. PAIR BLUETOOTH DEVICES

- 1) Go to [App Drawer \(All Application\)](#) | **Settings**  | **Connected devices**  | **Connection preferences** | **Bluetooth** .
- 2) Tap "+ **Pair new device**" to scan for available Bluetooth devices nearby.
- 3) Scroll through the list and tap the device you would like to pair.

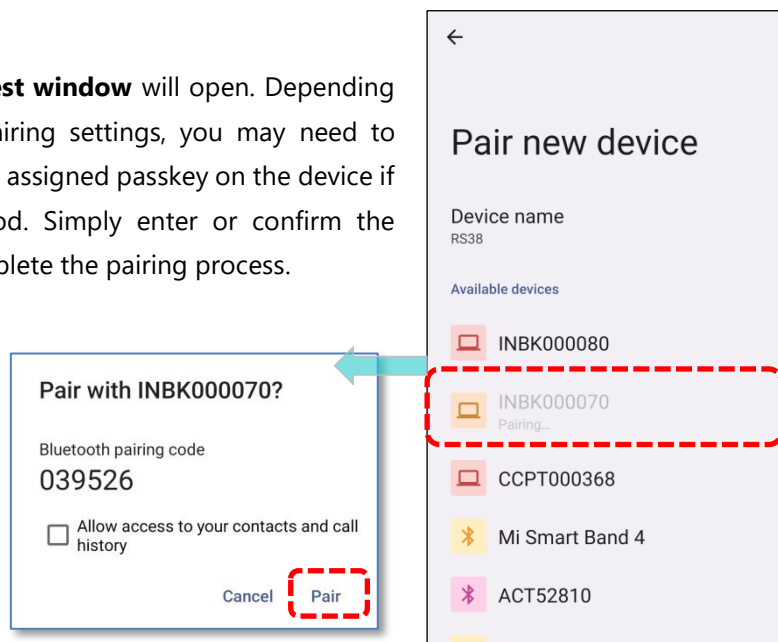

- 4) The **Bluetooth pairing request window** will open. Depending on the Bluetooth device's pairing settings, you may need to enter a passkey or confirm the assigned passkey on the device if using a smart pairing method. Simply enter or confirm the passkey on the device to complete the pairing process.



5) Once pairing is done, you can find the Bluetooth device in [App Drawer](#) | **Settings**  | **Connected devices**  | **Saved devices**.

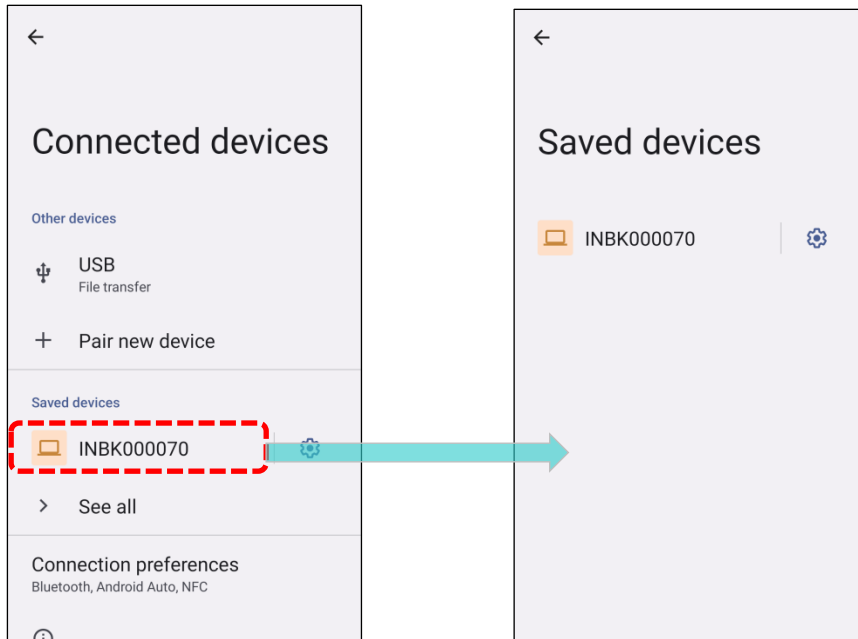

Note:

If the device you want to pair with is not listed, ensure that Bluetooth visibility is enabled on that device.

4.2.5. UNPAIR BLUETOOTH DEVICE

To unpair a paired device:

- 1) In the **Saved devices** list, tap the **setting button**  next to the saved device.

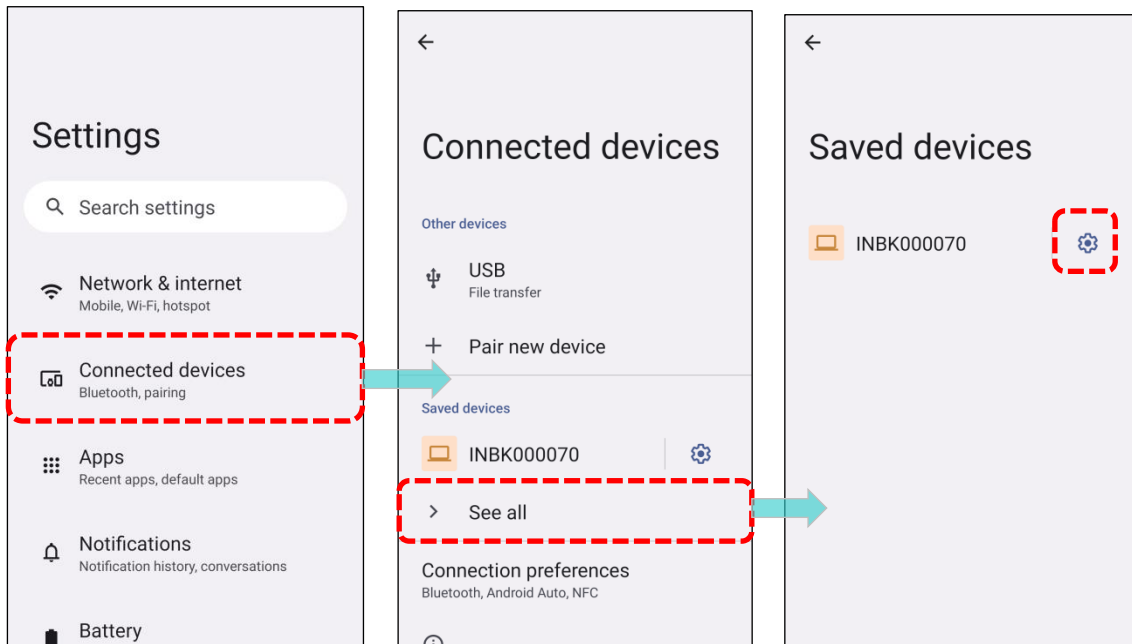



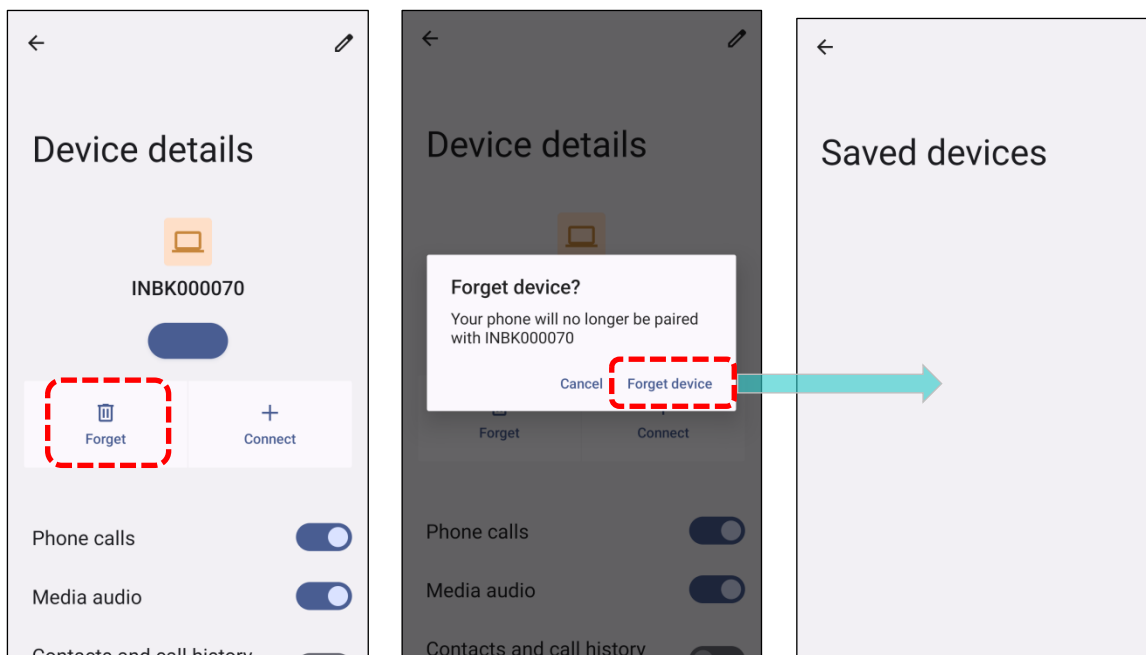

- 2) On the **Device details** screen, tap on **"FORGET"**.
- 3) Confirm by tapping **"Forget device"** in the pop-up window.



4.3. USE NEAR FIELD COMMUNICATIONS

Near field communications (NFC) utilize close proximity (4 cm or less) to establish radio communication through electromagnetic fields. When NFC is enabled, the mobile computer can collect information from NFC tags, exchange data with other NFC-supported devices, and, if authorized, even modify information on the NFC tag.

Before starting to communicate through NFC, follow these steps:

- 1) Go to [App Drawer \(All Application\)](#) | **Settings**  | **Connected devices**  | **Connection preferences** | **NFC**  .
- 2) Tap to switch on "NFC"  .

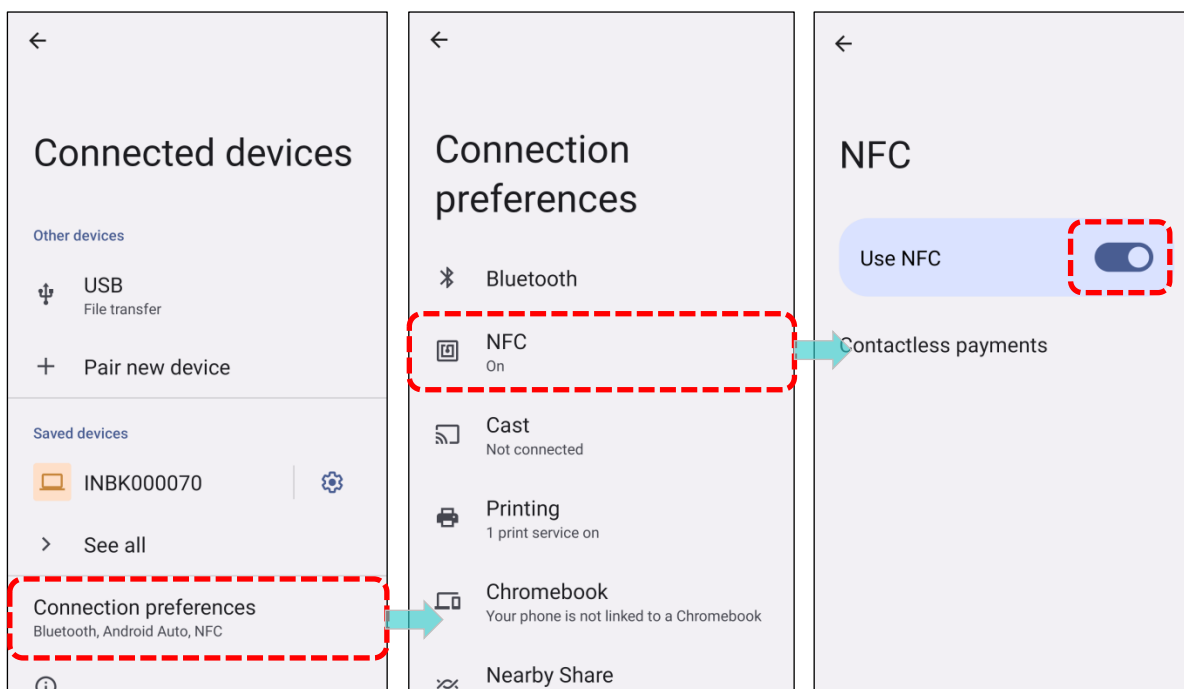

4.3.1. PAIR WITH NFC ENABLED BLUETOOTH DEVICES

- 1) Make sure that NFC and Bluetooth discovery are both enabled on the device you want to pair with.
- 2) Hold the mobile computer without covering the antenna area.

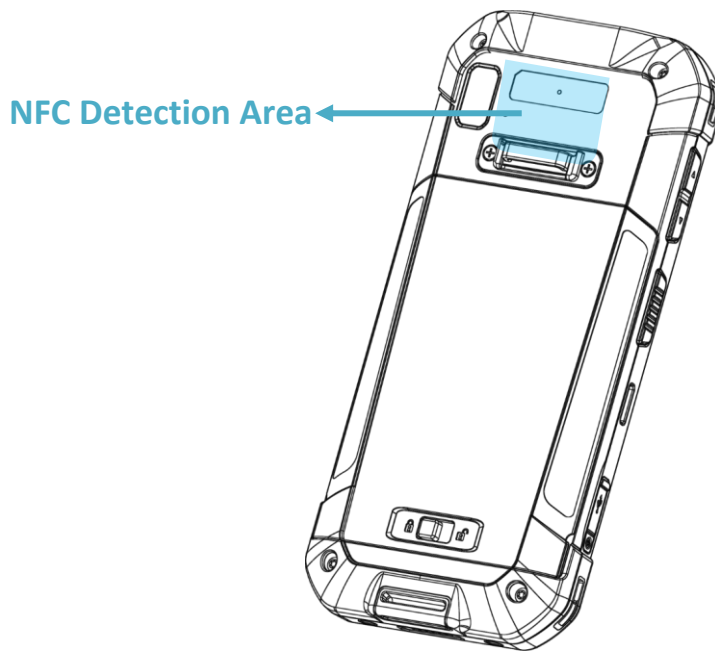

- 3) Move the mobile computer in proximity to the device for pairing, and a screen notification will appear to indicate successful pairing.

Note:

Once data transfer begins, maintain a distance of up to 10 meters (32.8 ft) between the two devices.

4.3.2. COMMUNICATION WITH NFC

- 1) Launch an NFC-enabled application on the mobile computer.
- 2) Hold the mobile computer without covering the antenna area.
- 3) Place the mobile computer close to the NFC detection area until the application indicates that data transfer is complete.

Chapter 5

CHAPTER 5. USING THE PHONE

The RS38 mobile computer supports phone calls and network connectivity through LTE (Long Term Evolution). To enable these features, insert the SIM card before powering on the device. Please refer to [Installing SIM Card and Memory Card](#).

Additionally, the device is equipped with eSIM and 5G technology for enhanced communication capabilities.

Note: RS38 Mobile Computer only supports Nano SIM card, and the Wi-Fi only model does not support SIM card.

IN THIS CHAPTER

| | |
|-------------------------------|-----|
| 5.1. SIM Card Management..... | 156 |
| 5.2. Phone Application | 160 |
| 5.3. Audio Modes | 170 |
| 5.4. In-call Volume | 171 |

5.1. SIM CARD MANAGEMENT

The default setting for cellular networks is **“Automatically select network”**. To manually select the cellular network, please:

- 1) Go to [App Drawer](#) | **Settings**  | **Network & Internet**  | **SIMs** .

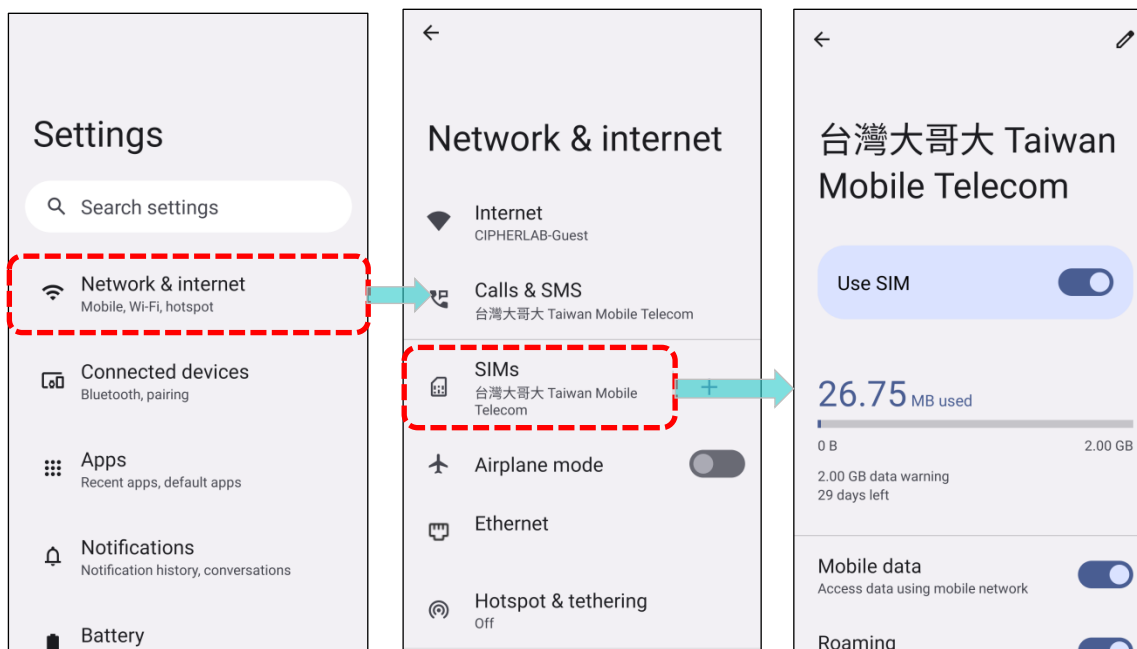

- 2) On the mobile network page, scroll to locate **“Automatically select network”** and disable it.

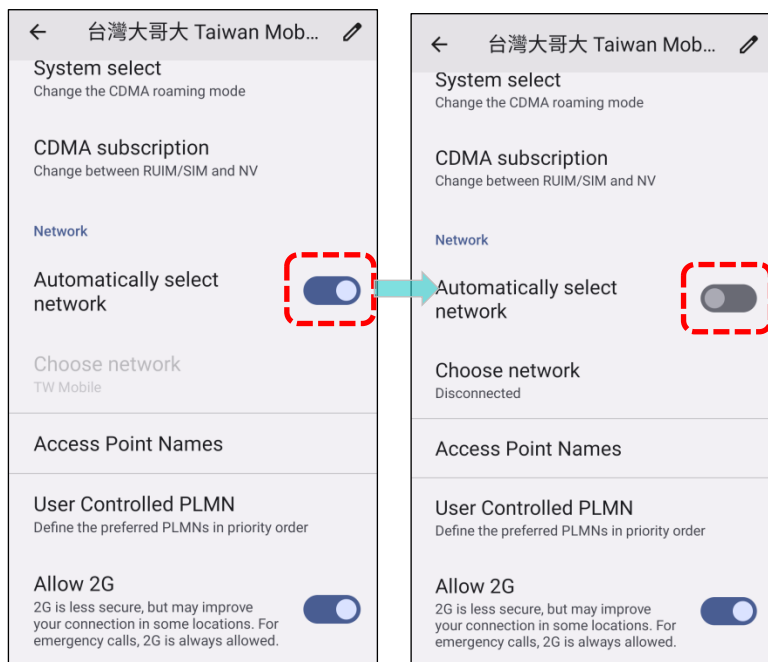

- 3) By turning off “**Automatically select network**”, “**Choose network**” pops up to list the network after searching. Select your preferred network from the list.

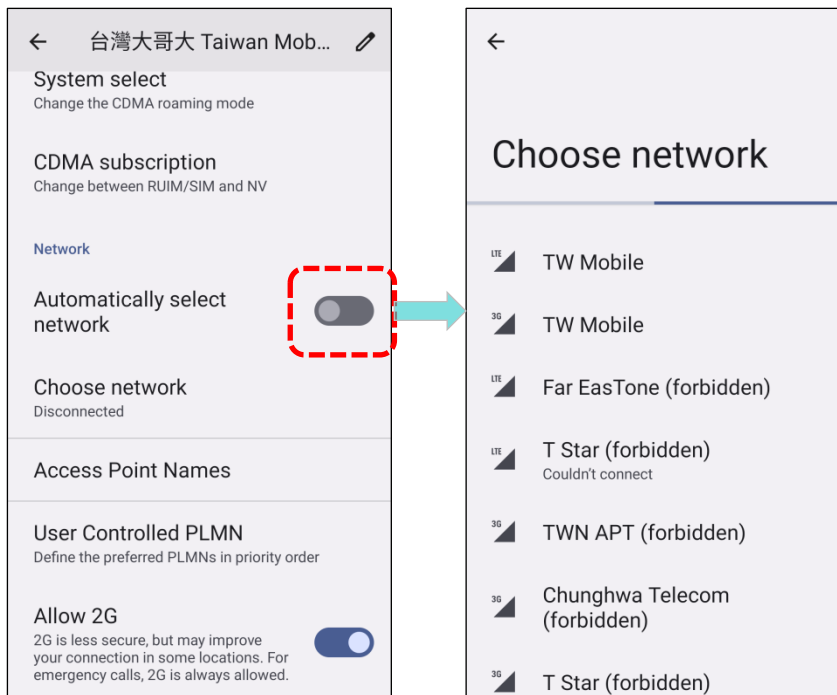

- 4) A notification appears if the selected network is unavailable. Please repeat the aforesaid steps to select the network again.

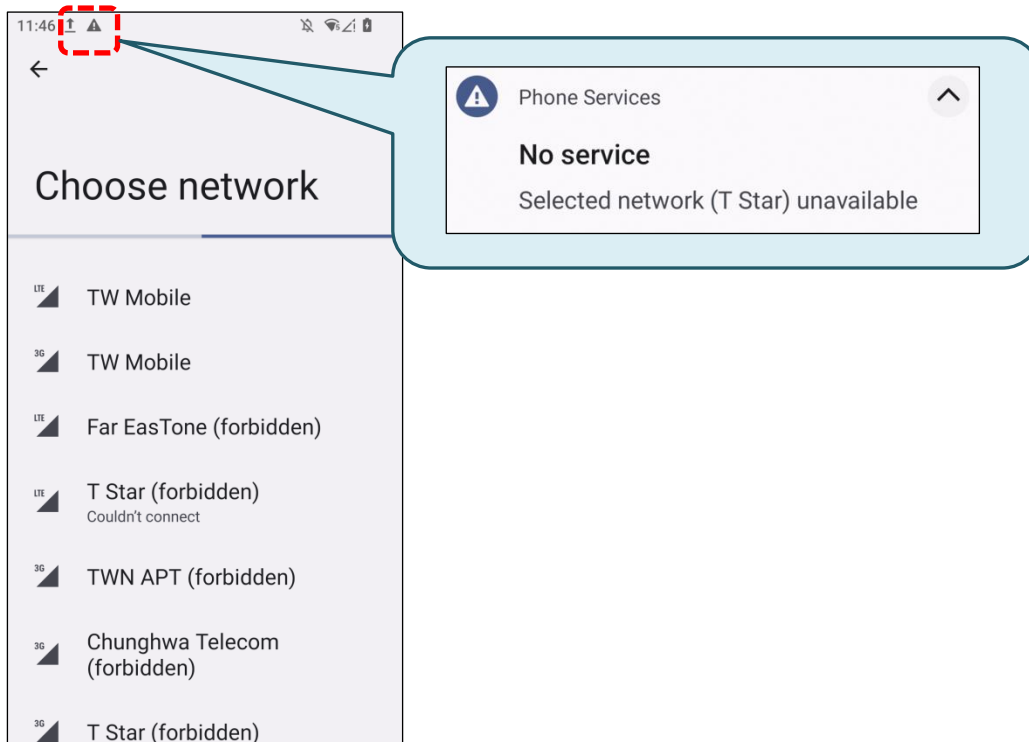

SETTING UP ESIM

eSIM is a digital alternative to physical SIM cards, streamlines the process of transferring or obtaining mobile plans.

To set up eSIM:

1) Go to [App Drawer](#) | **Settings**  | **Network & Internet** .

2) Tap **SIMs** , or tap on the plus icon **[+]** next to **SIMs** to add one.

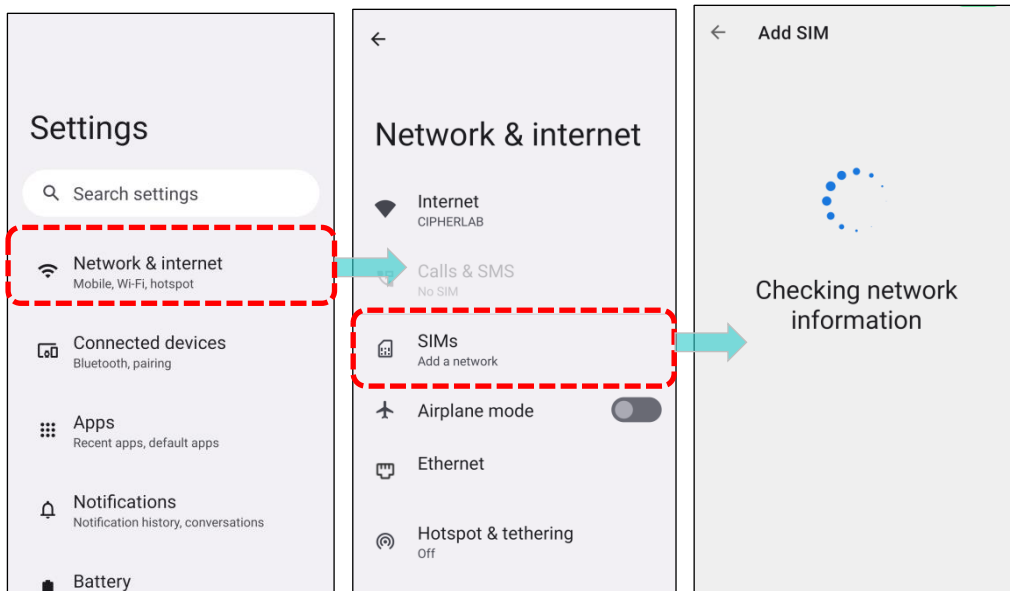

3) Scan the QR code or enter the activation code provided by your carrier.

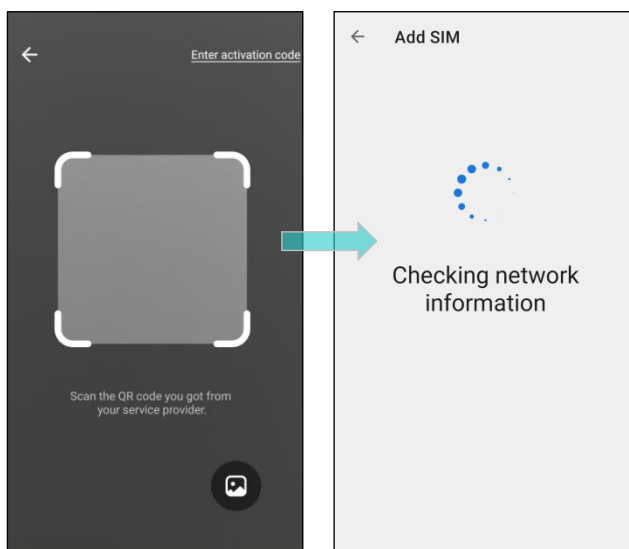

4) Confirm the eSIM information and tap **“Done”** to complete the download and installation of your eSIM.

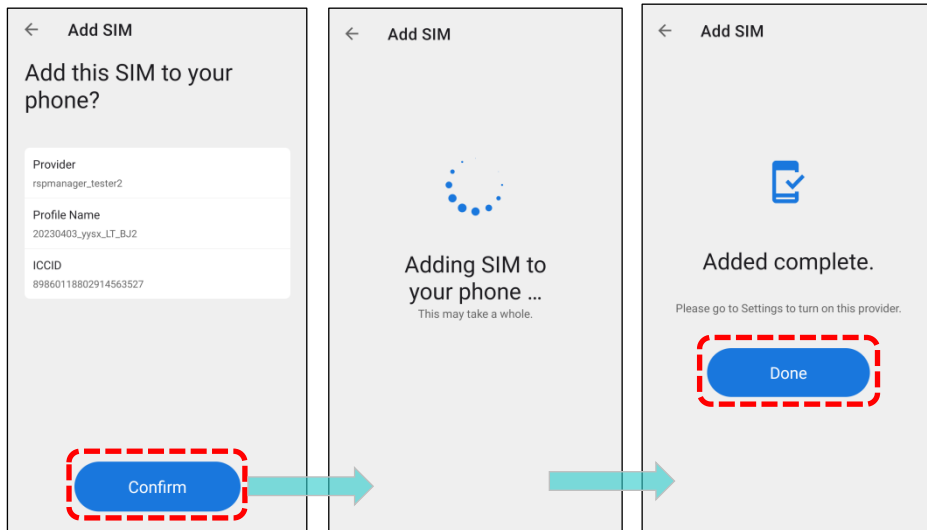

EMERGENCY CALLS

Depending on your service provider, the mobile computer may support making emergency phone calls even when the SIM card is locked or absent. Emergency phone numbers will vary by country.

5.2. PHONE APPLICATION

Once a SIM card is installed on the mobile computer or an eSIM is added and activated, a signal icon will appear at the top of the Quick Settings Menu, indicating the strength of the connection signal, enabling access to phone calls.

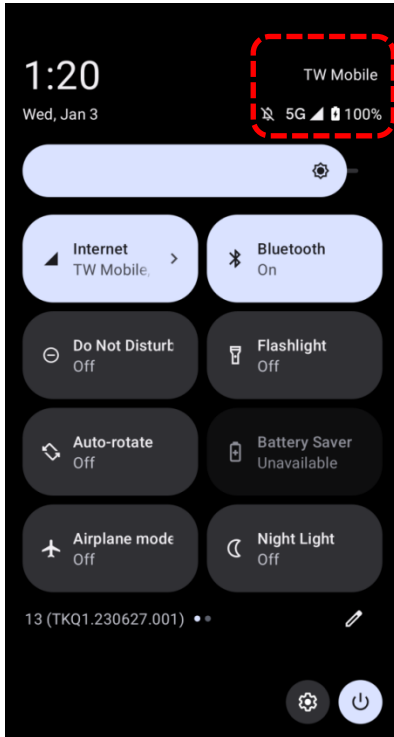

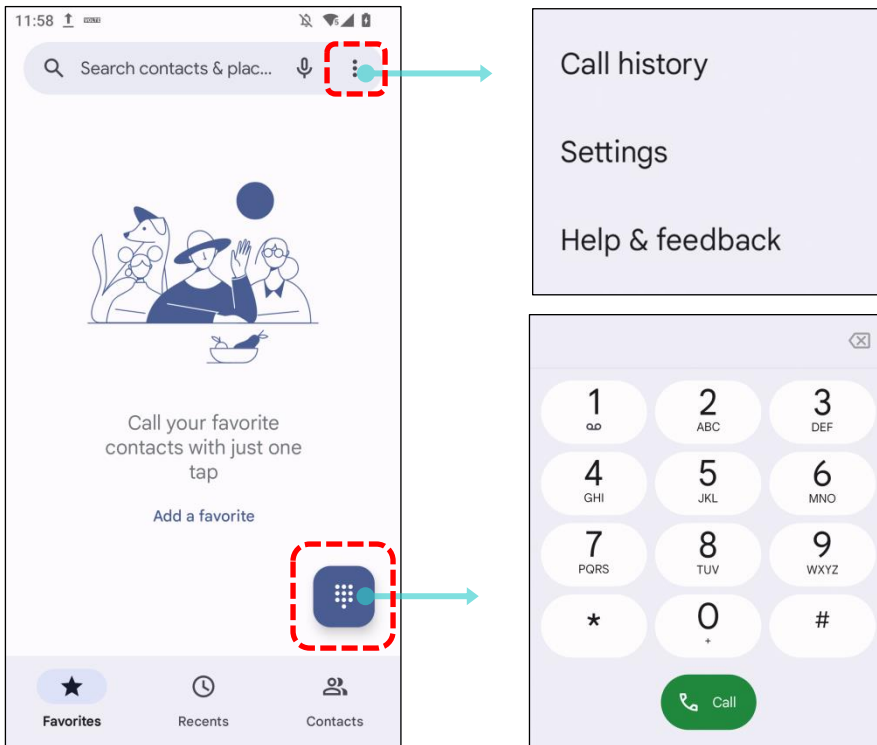

5.2.1. PHONE INTERFACE

To launch the phone application, please go to [App Drawer \(All Apps\)](#) | **Phone** .



The application "**Phone**" contains three tab pages:

| Item | Description |
|--|---|
|  Favorite | Display your favorite contacts & your frequent calls. |
|  History | List all the call history. |
|  Contacts | List your contacts. |

ADD FAVORITE CONTACTS

Your favorite contacts are displayed on **"Favorite"** ☆ tab pages for quickly making phone calls. To add a favorite contact:

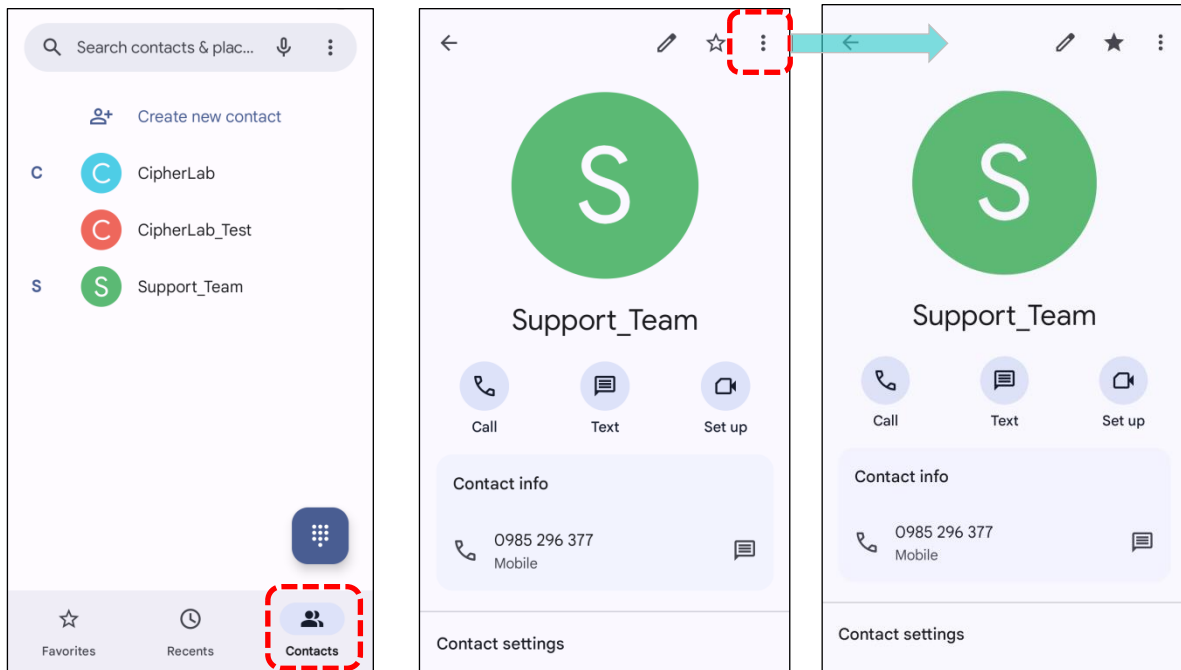

- 1) On **"Contacts"** 👤 tab page, tap on the contact you would like to set to be your favorite to enter the contact detail page.
- 2) Tap on the star mark on the upper-right to mark this contact as your favorite.

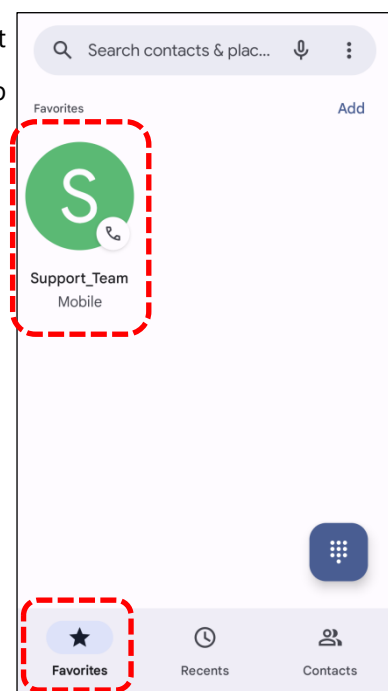

- 3) Return to **"Favorites"** ☆ tab page, the contact you just marked as favorite is now displayed on **"Favorites"** ☆ tab page.



5.2.2. PLACE CALL

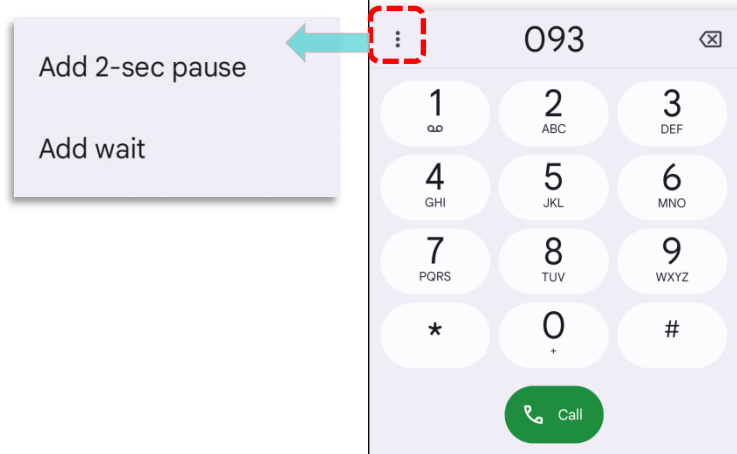

Tap  to expand the dial pad, enter the phone number in the dial pad, and tap  to initiate the call.

If you need to frequently make calls to an interactive voice system, you may tap  next to the number and select **Add 2-sec pause** for soft pause (a pause of 2 seconds to the buttons) or a hard pause (a pause that will wait for your confirmation to send the following digits).



PLACE CALL USING CONTACTS

To make a call by using contacts:



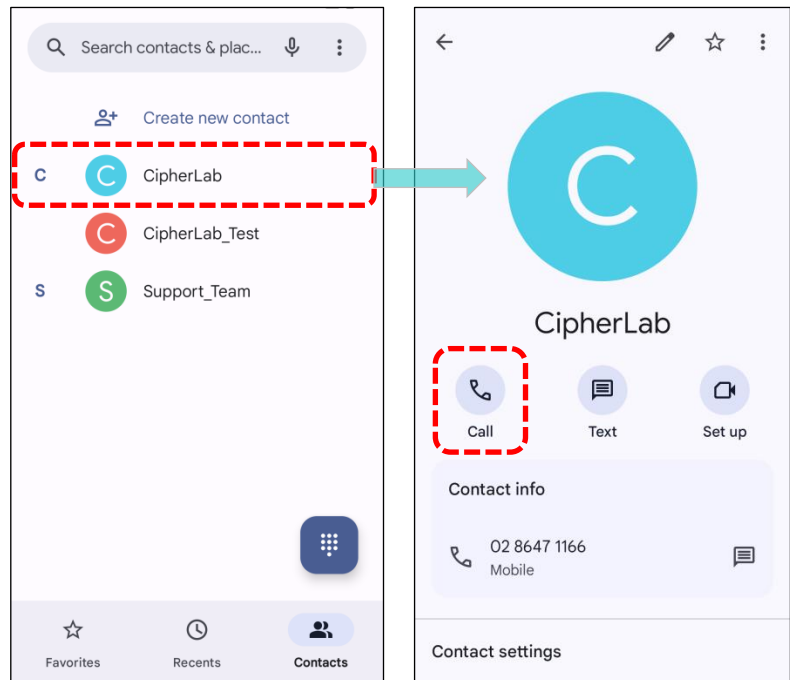



- 1) In the phone application page, tap to enter **"Contact"**  tab page.
- 2) Tap a contact to enter the contact detail page and then tap on **"Call"**  to initiate a call.

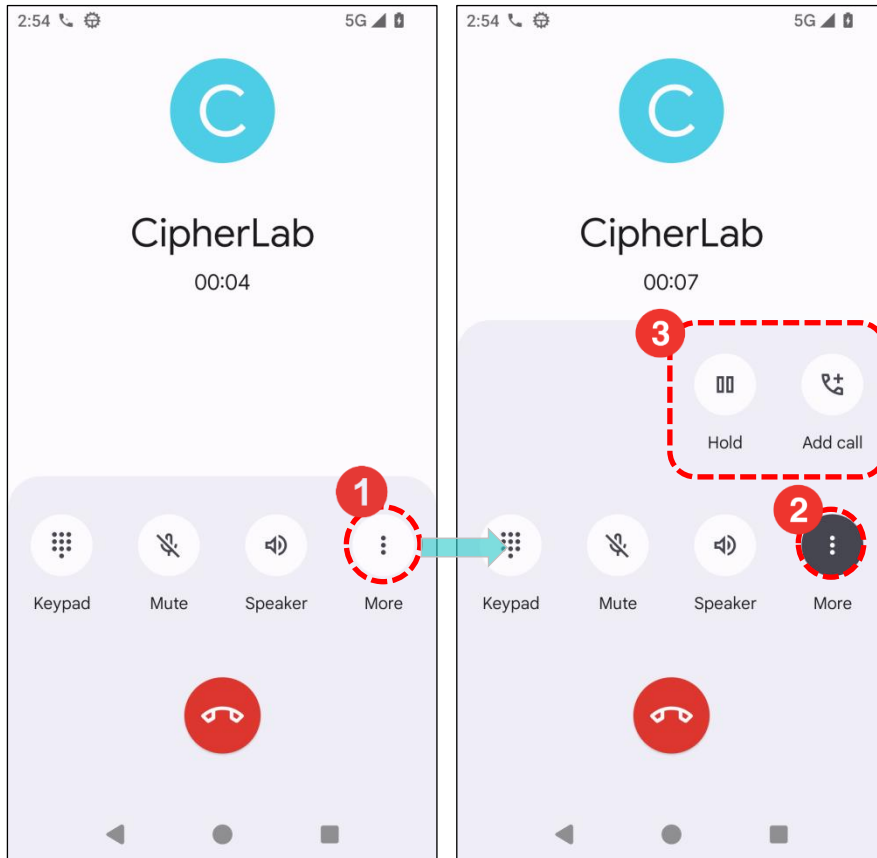

5.2.3. DURING A CALL

When a call is connected, the phone keypad features the following buttons. To hold the call or to add call, tap on **"More"**:



| Button | | Description |
|---|----------|---------------------------------|
|  | Mute | Mute the call. |
|  | Keypad | Open the numeric keypad. |
|  | Speaker | Turn on the speaker. |
|  | Add call | Add another person to the call. |
|  | Hold | Place the call on hold. |
|  | Hang up | End the call. |

5.2.4. RECEIVE INCOMING CALL

When receiving an incoming call, tap **Answer** to pick it up.

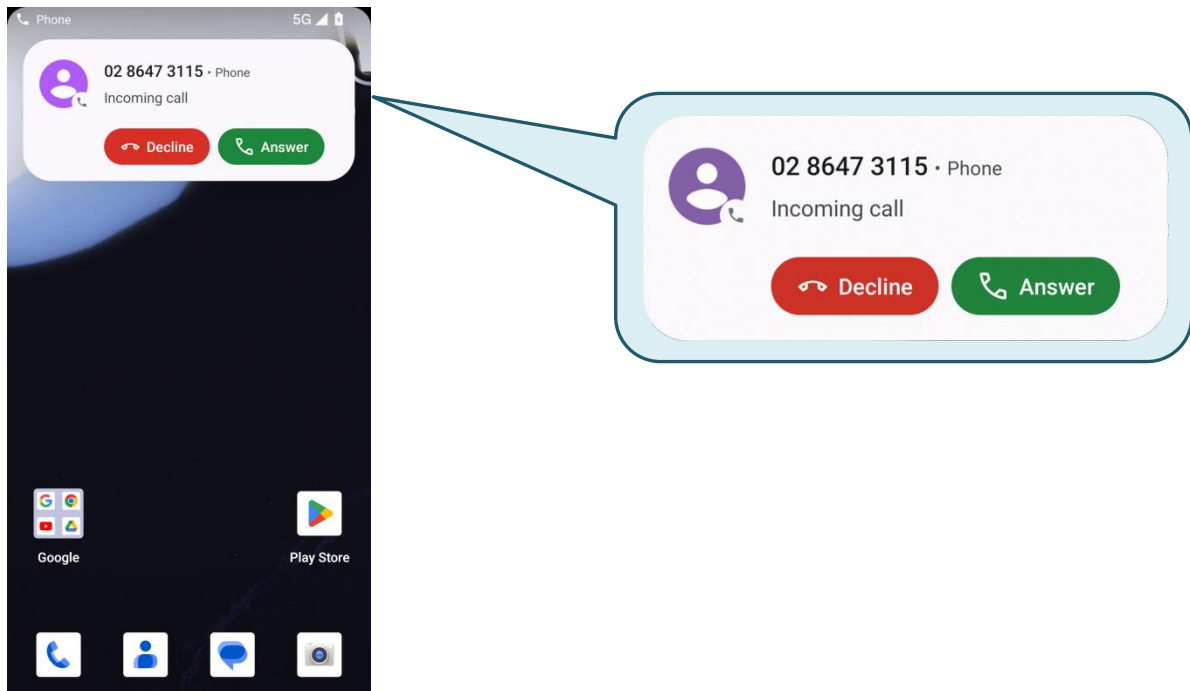

Incoming calls will be logged in the **Phone** application; in the case of a missed call, a notification will be displayed. Please refer to [Check Missed Calls](#).

To mute the ringtone of an incoming call, press the volume down button.

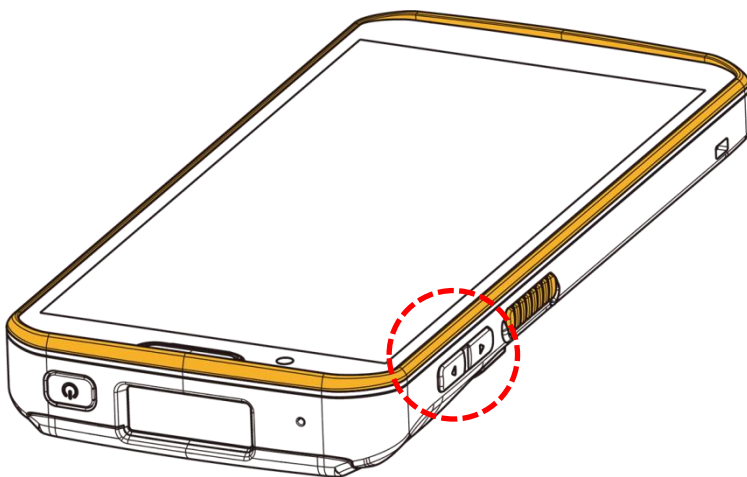

5.2.5. CHECK MISSED CALLS

If you have a missed call, a notification icon  will appear on the status bar. The missed calls notification will also be displayed on the lock screen.

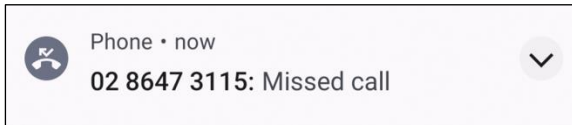

To manage notification on lock screen:

Go to [App Drawer \(All Apps\)](#) | **Settings**  | **Notifications**  | **Notifications on lock screen**, then choose the option that best suits your needs.

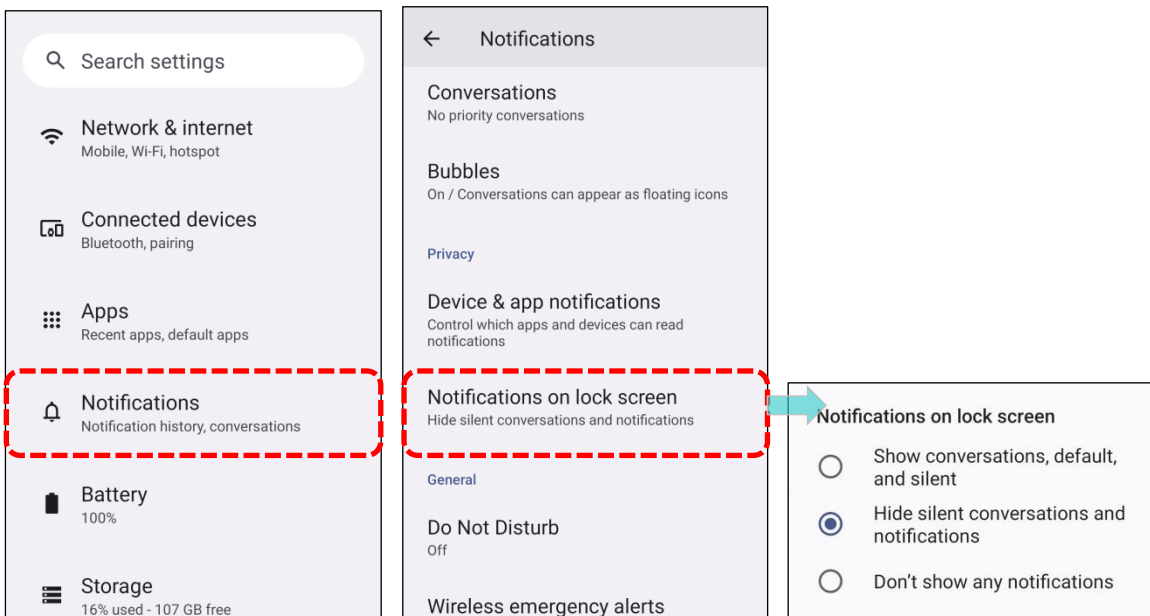

Unlock the screen and use the [Notifications Drawer](#) to manage the missed call.

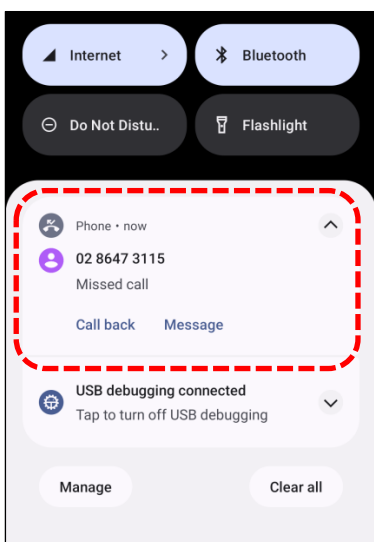



5.2.6. CALL HISTORY

To check the call history, open the Phone application and tap to enter the **Recents**  tab, where a list of recent calls is displayed.

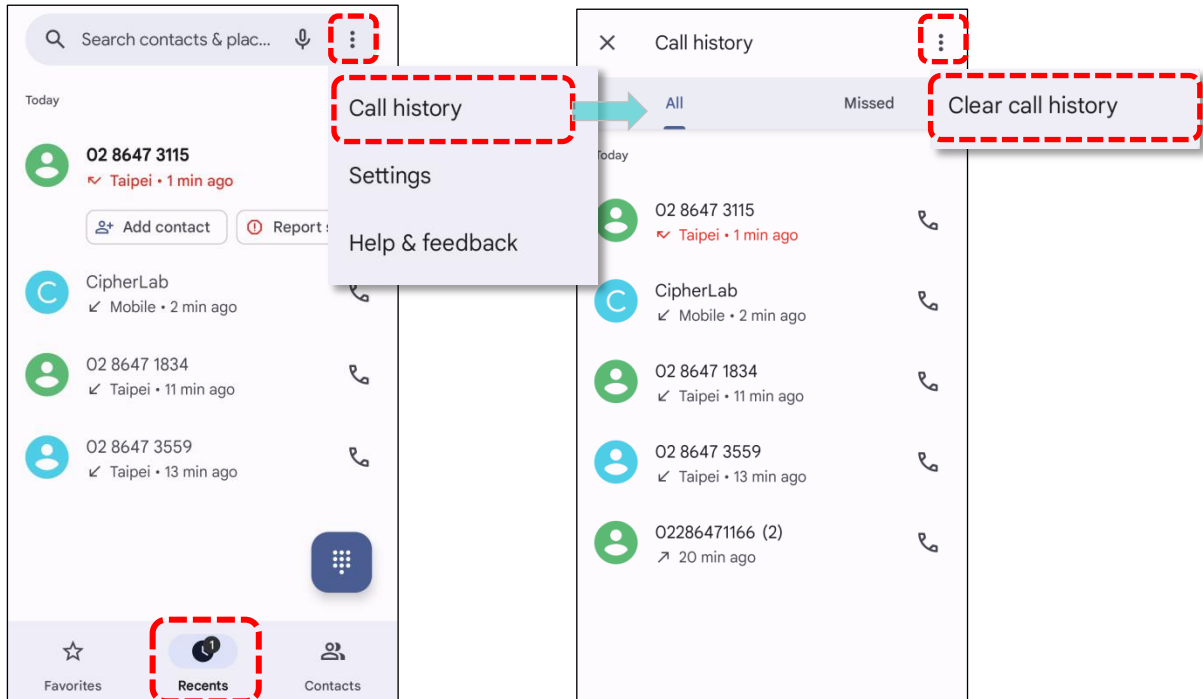
Alternatively, tap on the more button , then choose **“Call history”**.



| Item | Description |
|---|------------------|
|  | Connected calls. |
|  | Missed calls. |

Tap the phone icon  next to a call record to place back the call.

To clear call history, first tap on the more button  on **Call history** page, then tap **“Clear call history”**.

5.2.7. CALL SETTINGS



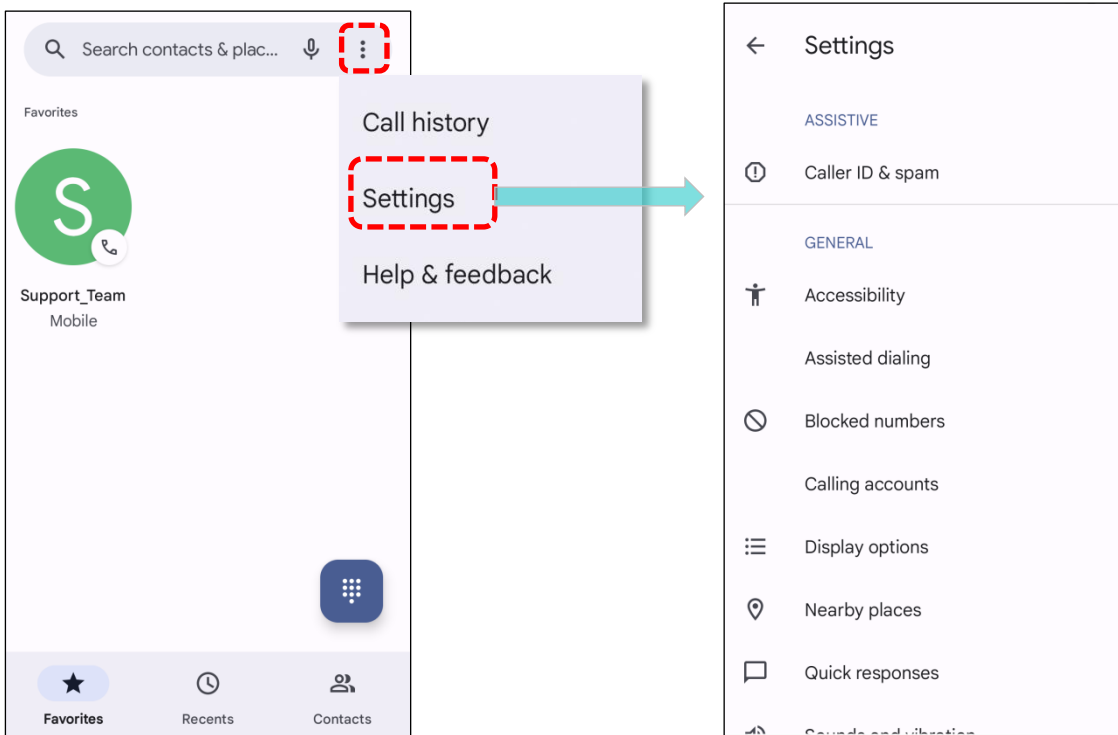







Tap on more button  and select **Settings** to enter the settings page:



Tap on each setting for more setting options.

5.2.8. MAKE MULTI-PARTY CALLS

To make multi-party conference calls:

- 1) On the Phone application page, enter the 1st number to call and tap  to initiate the call.
- 2) After the call has begun, tap **Add call**  to add another member. The 1st call will be put on hold.
- 3) Select the 2nd member from call log or contacts to call directly, or tap the dial pad  to input the phone number to call and tap  to initiate the call.
- 4) When the 2nd call is connected, the first call will continue to be on hold. Tap the merge call button  to add the 1st call to the conversation. A three-party conference call is initiated.
 - To add a 4th member, please tap . The three-party call will be put on hold. Follow the step similar to step 3 to initiate the call. When the call is connected, the three-party call will continue to be on hold. Tap the merge call button  to add the three-party call to the conversation. A four-party conference call is then initiated.
 - Tap **Manage Conference Call** to view all members of the call.
 - To remove a member, tap  next to the member.
 - To speak with a member in private, tap  next to the member, and the conference call will be put on hold. Tap  to return back to the conference call.

5.3. AUDIO MODES

The mobile computer offers three different audio modes for phone calls:

HANDSET MODE

Handset Mode is the default audio setting that utilizes the receiver above the touchscreen for audio output during calls.

SPEAKER MODE

Speaker Mode utilizes the built-in speaker for audio output during calls.

HEADSET MODE

In **Headset Mode**, you can connect a Bluetooth headset or a wired headset to the mobile computer for audio output during calls.

USE BLUETOOTH HEADSET

Please refer to [Pair Bluetooth Devices](#) to connect the mobile computer to a Bluetooth device. Note that the speakerphone is automatically muted when a Bluetooth headset is connected.

USE WIRED HEADSET

The RS38 mobile computer supports a USB Type-C audio adapter for connecting headsets. To use this feature, insert a USB Type-C audio adapter into the USB-C port and connect it with a wired headset. Note that the speakerphone is automatically muted when a wired headset is connected.

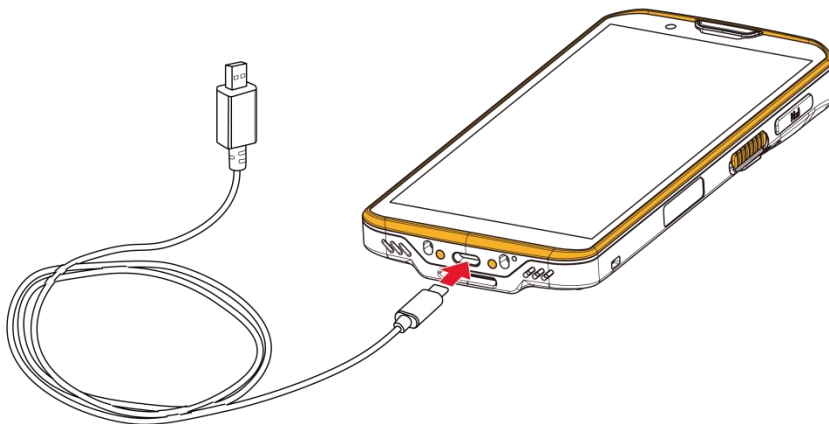

5.4. IN-CALL VOLUME

Use the **Volume Buttons** to adjust the ringer volume and system sound level. During a call, use the volume buttons to adjust the in-call conversation volume.

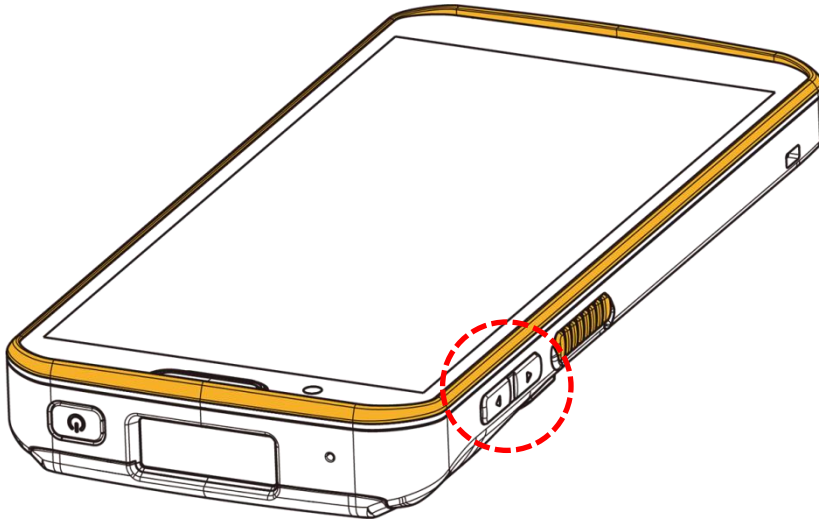

Chapter 6

CHAPTER 6. CIPHERLAB UTILITIES

This chapter introduces the built-in applications developed by CipherLab. You can access these applications in your App Drawer.

IN THIS CHAPTER

| | |
|---------------------------------|-----|
| 6.1. A-Demo..... | 173 |
| 6.2. AppLock..... | 175 |
| 6.3. Barcode To Setting..... | 176 |
| 6.4. BT Printer Mate..... | 181 |
| 6.5. Button Assignment..... | 181 |
| 6.6. Enterprise Settings..... | 182 |
| 6.7. HF RFID Configuration..... | 183 |
| 6.8. ReaderConfig..... | 184 |
| 6.9. Signature Capture..... | 185 |
| 6.10.SIP Controller..... | 186 |
| 6.11.Software Trigger..... | 190 |
| 6.12.LogGen..... | 194 |
| 6.13.Wireless Init..... | 195 |
| 6.14.Ping..... | 196 |
| 6.15.DisplayLink..... | 199 |

6.1. A-DEMO



A-Demo is an application that provides a brief introduction to all the built-in applications developed by CipherLab.

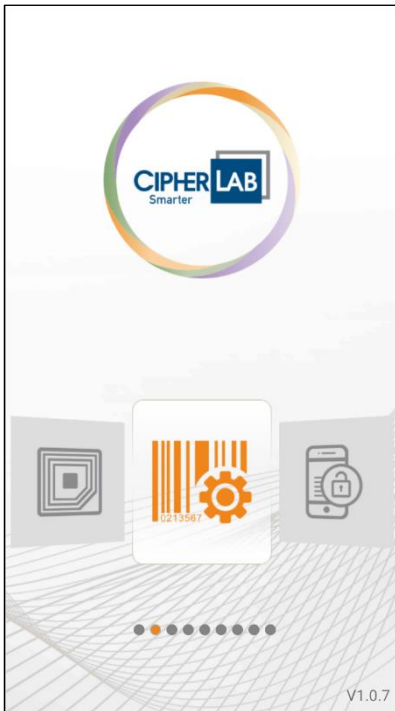

Enter the main screen and swipe left or right to select the item to get the function introduction.

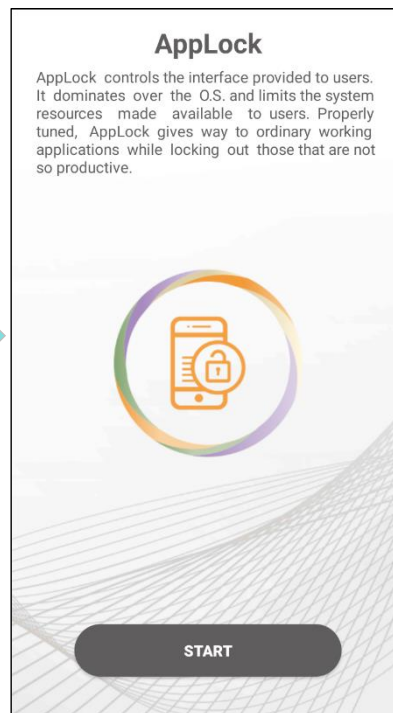
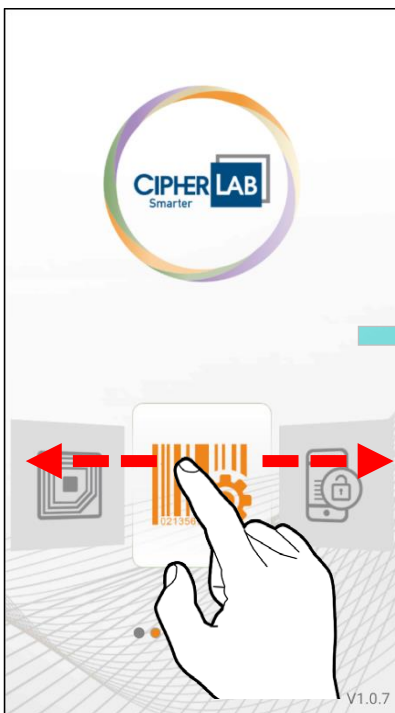

Users can launch these apps by tapping “**START**” on the App’s introduction page.

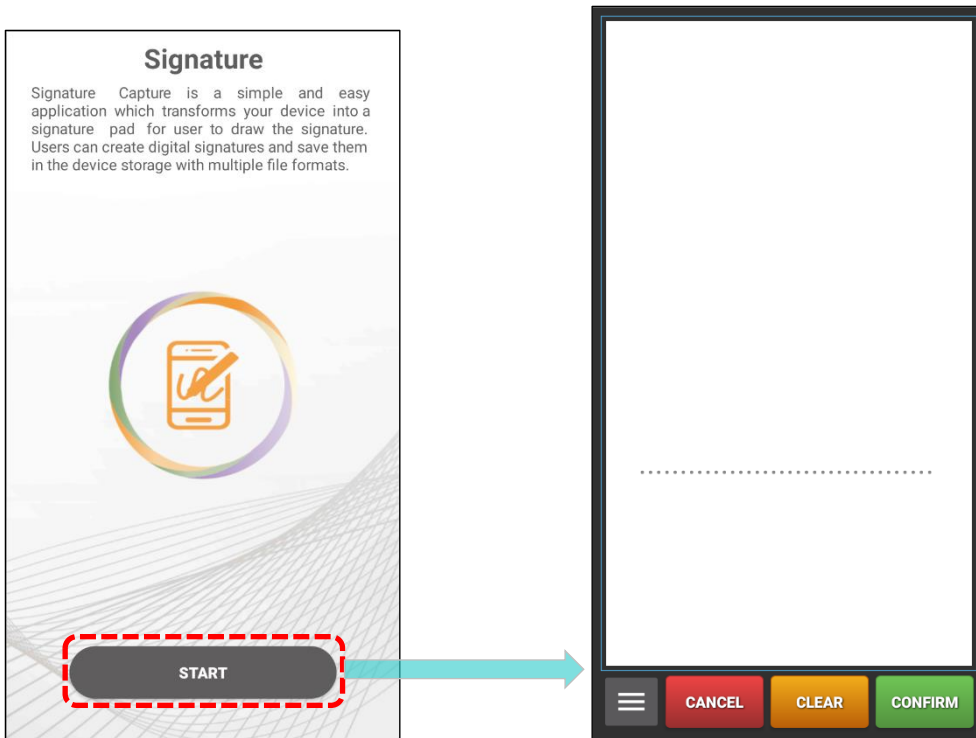

6.2. APPLOCK



AppLock controls the interface provided to users, exerting over the operation system and restricting access to system resources. When properly configured, AppLock allows productive applications to function normally while restricting access to less productive ones.

If you have a collection of mobile computers, you can easily apply a uniform user environment to the entire group without significant time and effort. This can be achieved by duplicating a copy of master settings across all your mobile computers.

For detailed information, please refer to [AppLock User Guide for Android](#).

6.3. BARCODE TO SETTING



BarcodeToSetting is designed to read the setting barcodes generated by **ADC (Android Deployment Configurator)** in order to apply the configuration. Launching “**BarcodeToSetting**” will display the main screen as shown below:

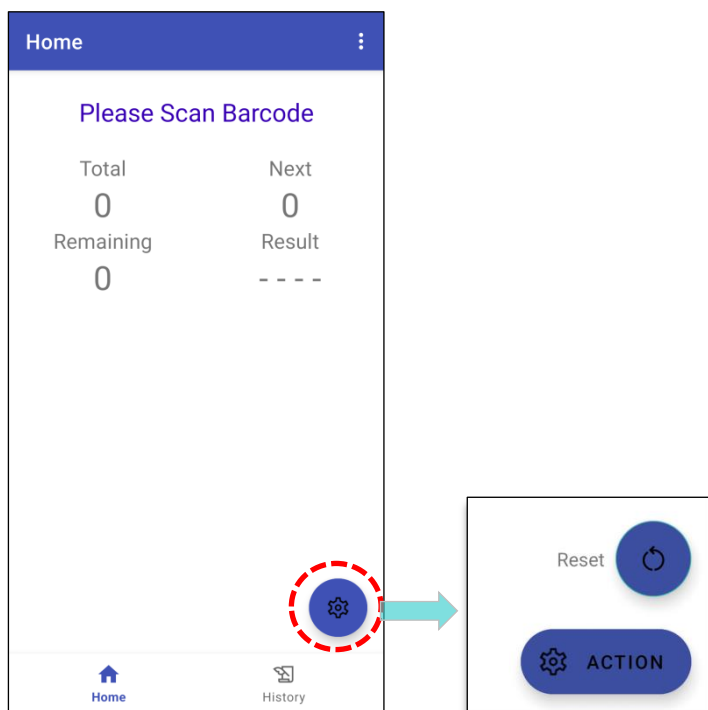

| Item | Description |
|-----------|--|
| Total | The total amount of the barcodes to be scanned. |
| Next | The item number of the next barcode to be scanned. |
| Remaining | The amount of the remaining barcodes to be scanned. |
| Result | The setting result will be “Success” or “FAIL”. |
| Reset | Tap on  to initialize the data. |

The setting barcodes you generated by **ADC** might be 1D or 2D as the example figures shows:

- 1D barcodes:

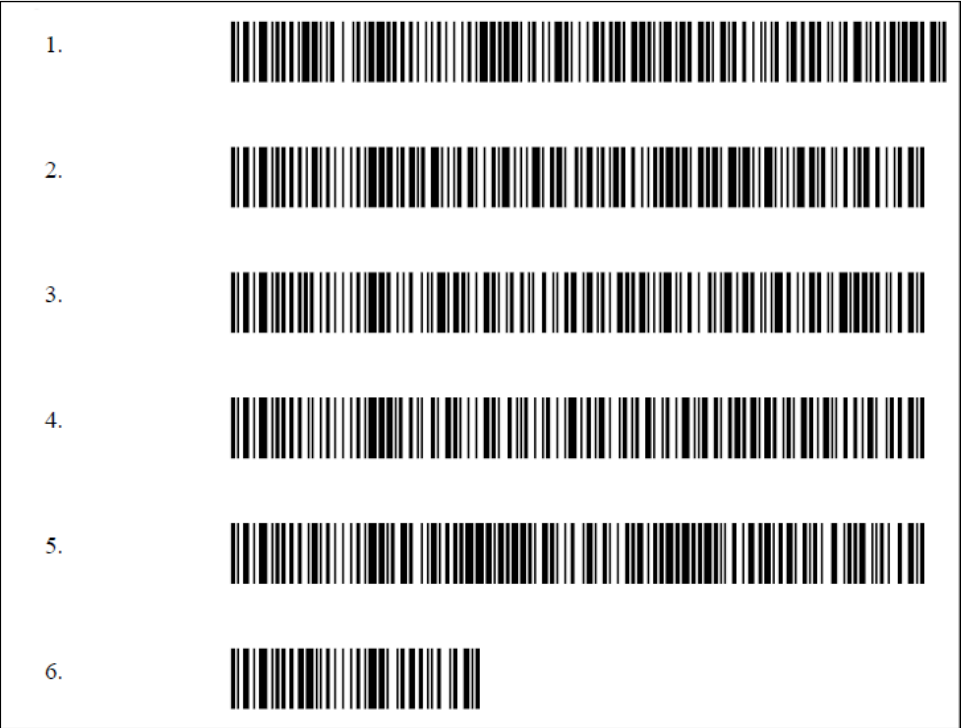

- 2D barcode:



HOW TO APPLY THE SETTINGS BY SCANNING BARCODE

Simply aim the scanning window at the barcode to read and press any of the side trigger. The scanning light beams to read the printed barcodes.

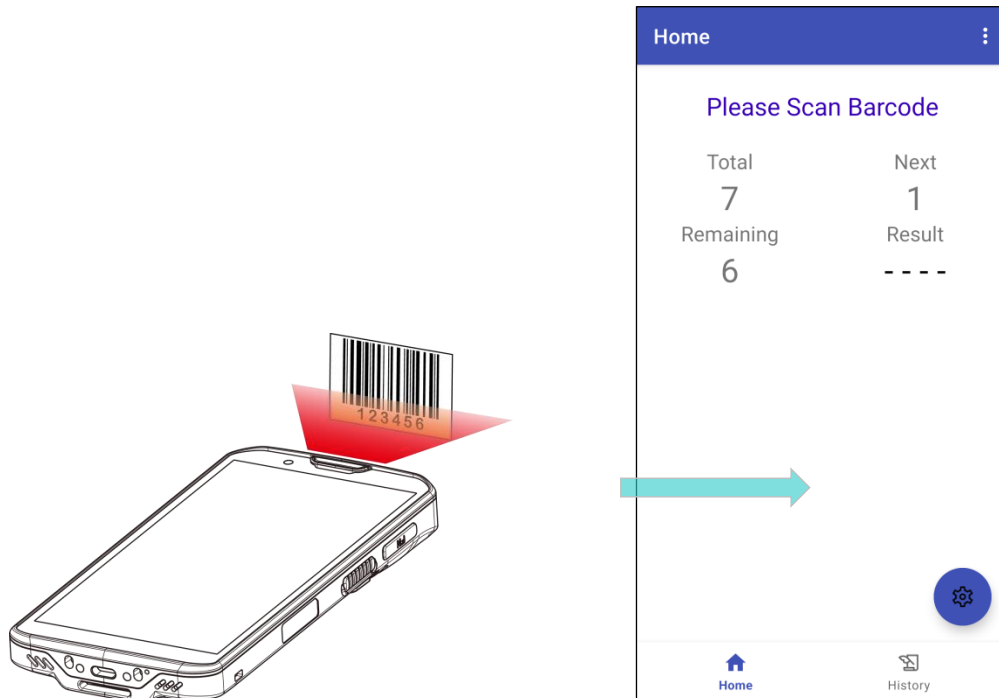

After scanning the setting barcodes, it takes a few seconds for your device to apply the configuration. Once the process is complete, the screen will display "Success".

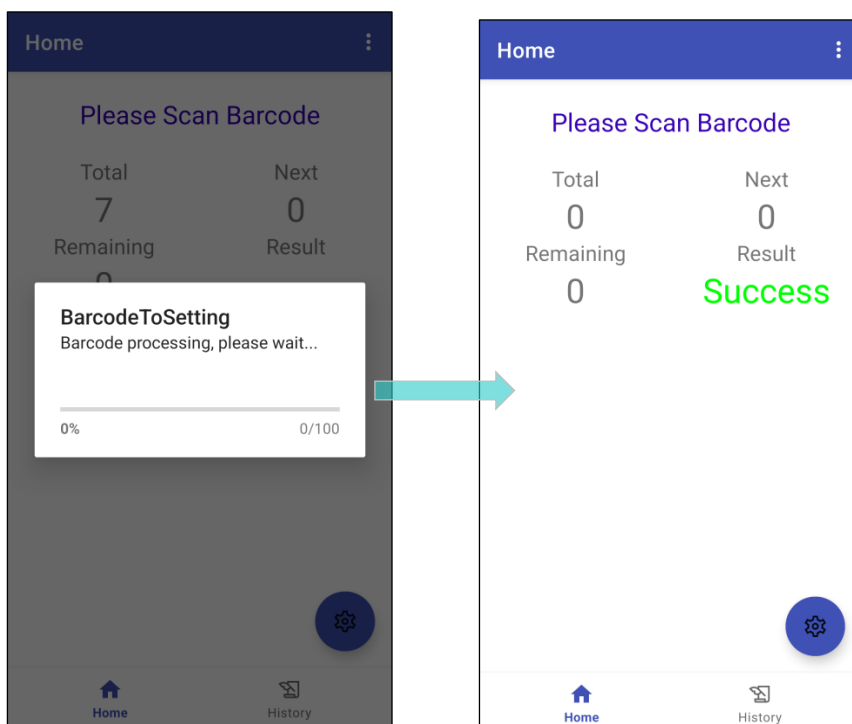

RESET (DATA INITIALIZE)

During the scanning procedure, you have the option to perform a **Reset** to start over. Alternatively, after completing the configuration, you can tap the **Reset** button to scan other barcodes you generated and apply additional settings.

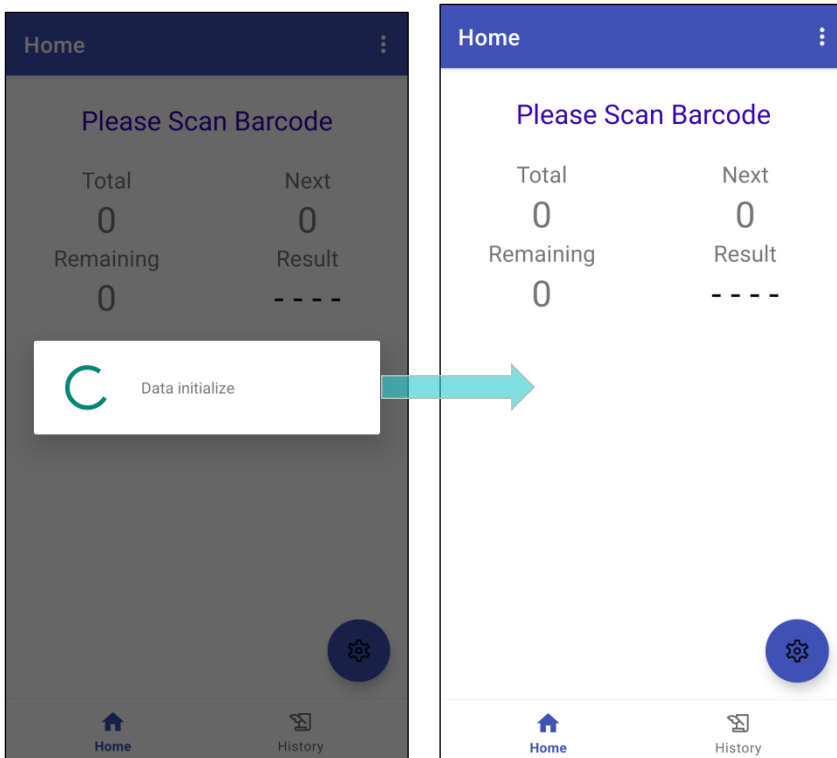
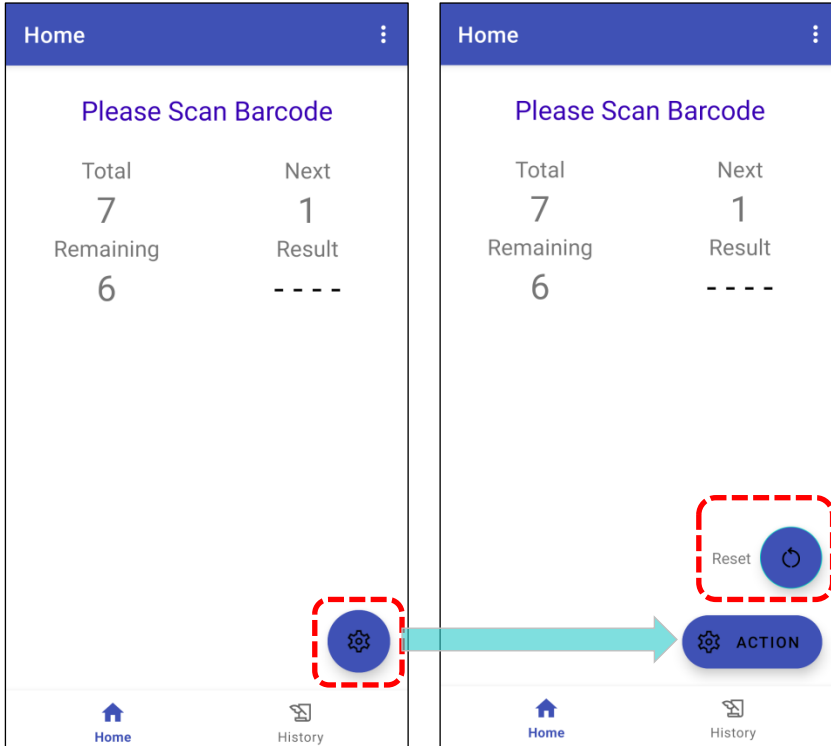

MORE MENU

Tap on the more button  on the action bar to open the more menu.

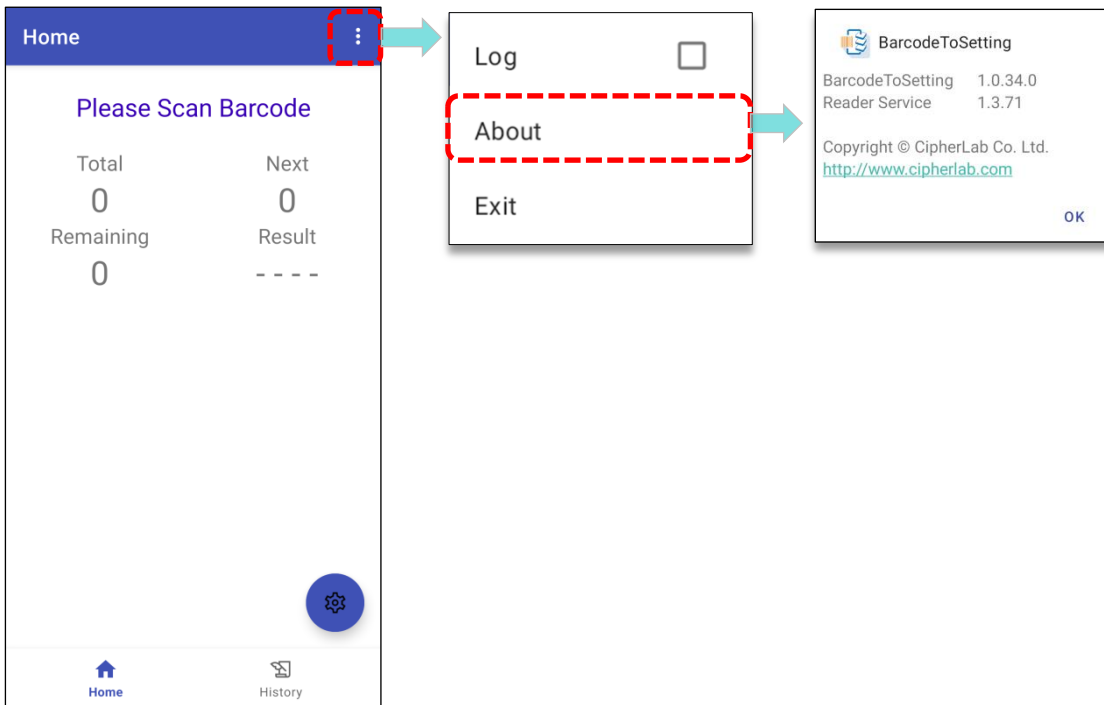

The items on the more menu:

| Item | Description |
|-------|---|
| Log | Check the checkbox to enable recording of events that occur during "BarcodeToSetting" runs. |
| About | Show the current version of "BarcodeToSetting" and "Reader Service". |
| EXIT | Close and leave "BarcodeToSetting". |

6.4. BT PRINTER MATE



BT Printer Mate is an application which provides user interface to pair with Bluetooth printers.

6.5. BUTTON ASSIGNMENT



Button Assignment can redefine the functions of physical keys so that they trigger different actions. Settings made to one or more keys can be saved as a profile, allowing users to switch conveniently in between different sets of settings.

Users can change key behavior of the device with keypad by the application "**Button Assignment**" while changing the key behavior of device without keypad by "**Programmable Keys**" in settings.

For detailed information, please refer to [Button Assignment User Guide for Android](#).

6.6. ENTERPRISE SETTINGS



Enterprise Settings in RS38 mobile computer offers various functional settings tailored to the project model.

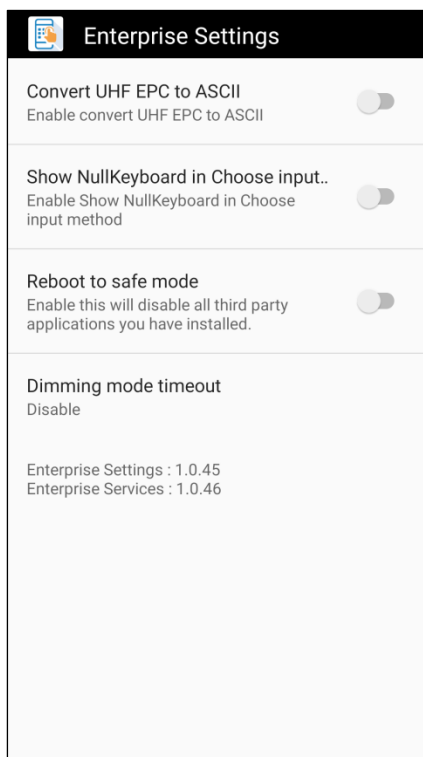

DIMMING MODE TIMEOUT

“**Dimming Mode Timeout**” is disabled by default.

To enable this function, choose the provided option of idle time.

When the selected idle time is reached, the screen will automatically dim for power-saving purposes. Unlike the suspend mode, both the background and apps continue to run during the dimming mode.

VERSION

The version information about Enterprise Settings is listed right below “**Dimming mode timeout**”.

6.7. HF RFID CONFIGURATION



HF RFID Configuration is a NFC application designed for reading and writing NFC tags and RFID compatible chips. Simply place the NFC tag or RFID chip close to the NFC detecting area of your device to initiate the process. Users can customize the behavior of the NFC reader through settings in HF RFID Configuration by enabling it.

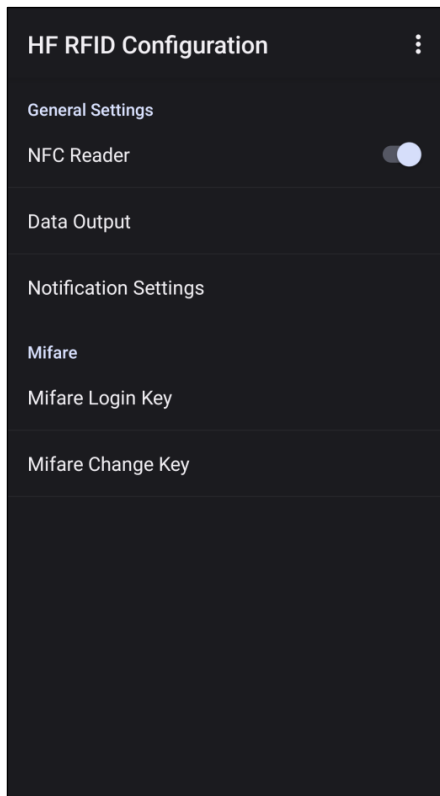

For detailed information, please refer to [HF RFID Configuration User Guide for Android](#).

6.8. READERCONFIG



ReaderConfig is a built-in application designed for configuring the scan engine within the mobile compute. It enables users to customize their scanner preferences and specify how decoded data is output. Users can use symbology and scanner settings and export them as a profile for importing again or implementing identical Reader Config settings on multiple devices.

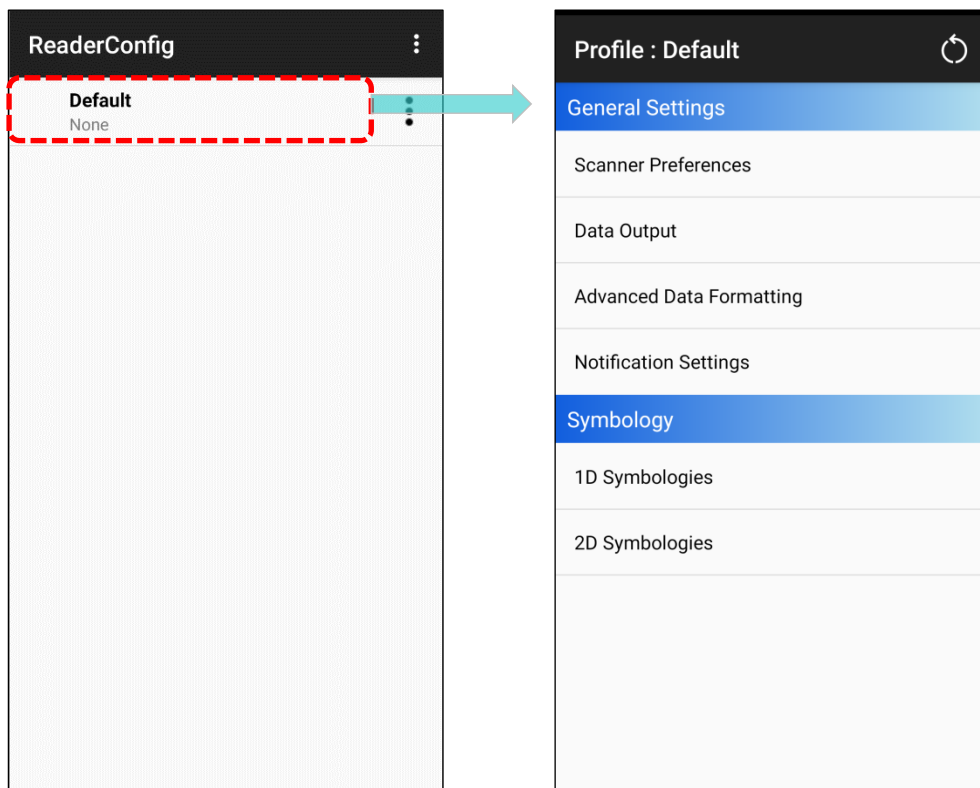

For detailed information, please refer to [ReaderConfig User Guide for Android](#).

6.9. SIGNATURE CAPTURE



Signature Capture is a simple and easy application which transforms your device into a signature pad for user to draw the signature. Users can create digital signatures and save them in the device storage with multiple file formats.

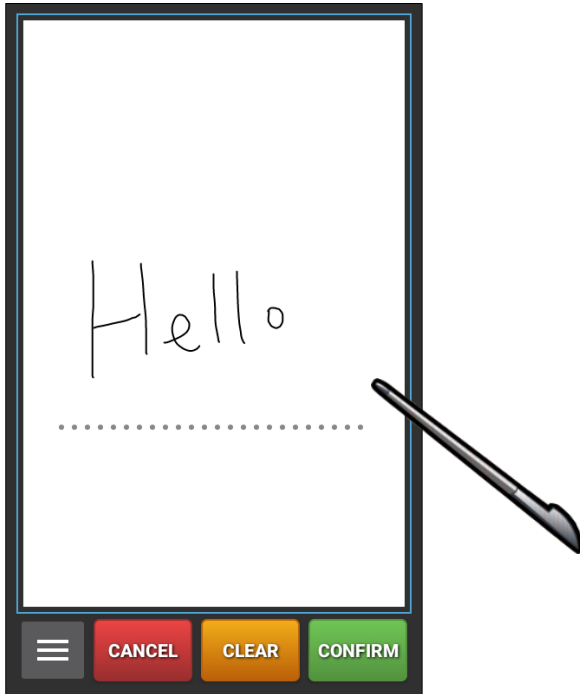

For detailed information, please refer to [Signature Capture User Guide for Android](#).

6.10. SIP CONTROLLER





SIP Controller is a built-in application that allows users to quickly open or close the virtual keyboard by tapping on the floating button.

LAUNCH SIP CONTROLLER

To launch SIP Controller:

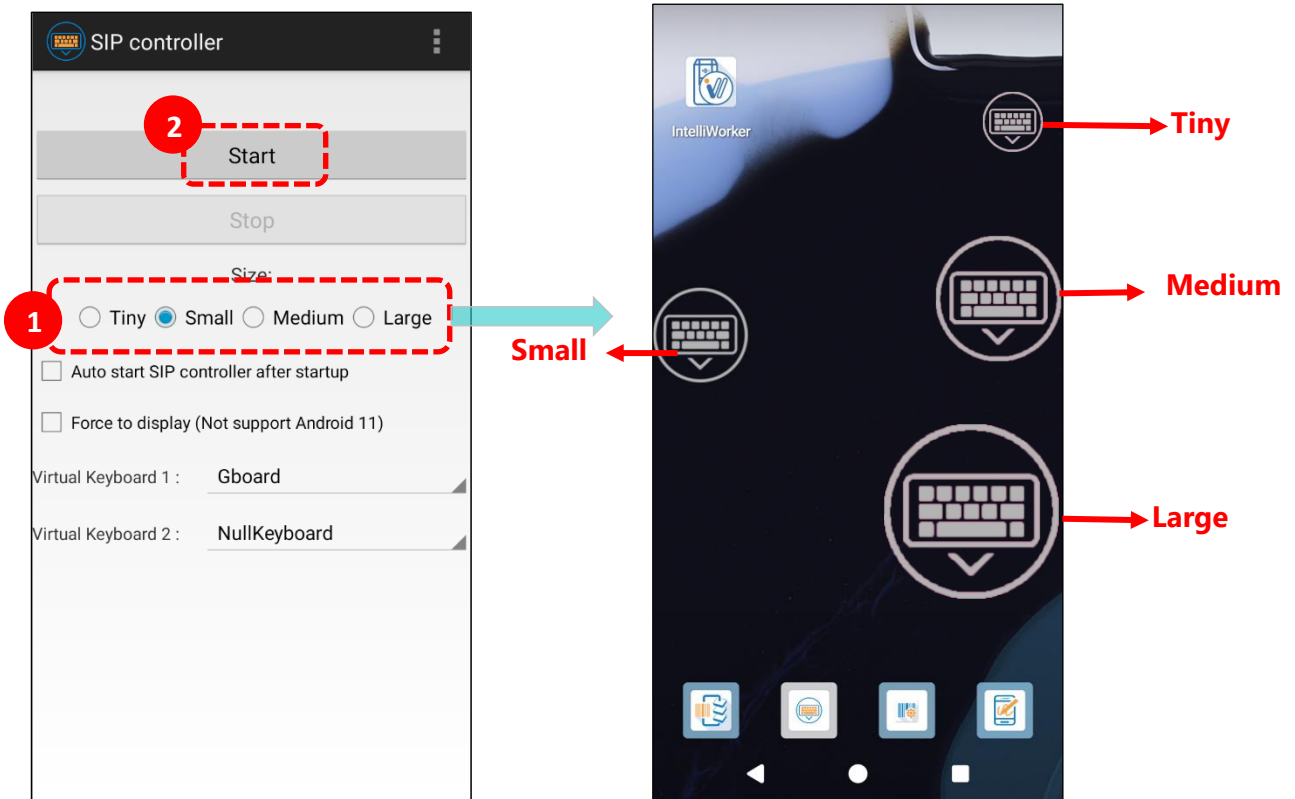
- 1) On **App Drawer** screen, tap on **"SIP Controller"**  to enter the main screen.
- 2) Select the size of the SIP Controller, then tap on **"Start"**.



-
- 3) Now, the **"SIP Controller"** button  appears on the screen, allowing you to invoke the virtual keyboard by tapping on it. Additionally, you have the flexibility to drag this button to any position on the screen.

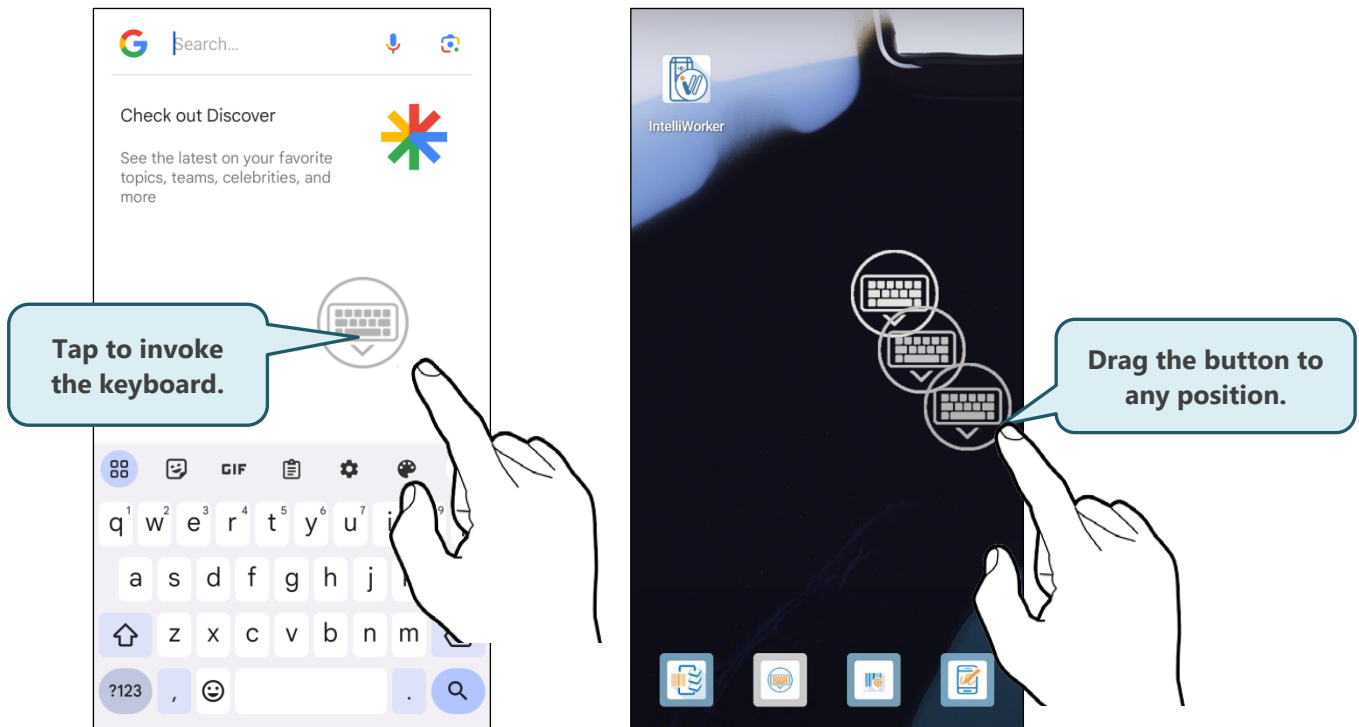

AUTO START

Enabling **"Auto start SIP controller after startup"** ensures that the SIP Controller will automatically start up on device boot. Simply check the checkbox to enable this function.

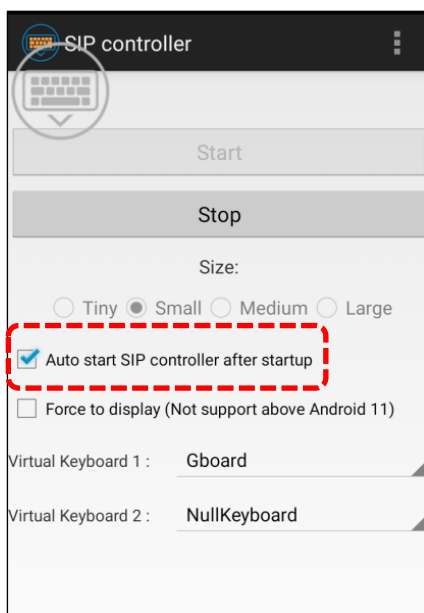

FORCE TO DISPLAY

“Force to display” is ineffective for the device whose OS is above Android 11.

SWITCH VIRTUAL KEYBOARD

You can configure “Virtual Keyboard 1” and “Virtual Keyboard 2” to be the keyboards invoked by **SIP Controller**. Tap on the button to cycle through “Virtual Keyboard 1” and “Virtual Keyboard 2” options you have set.

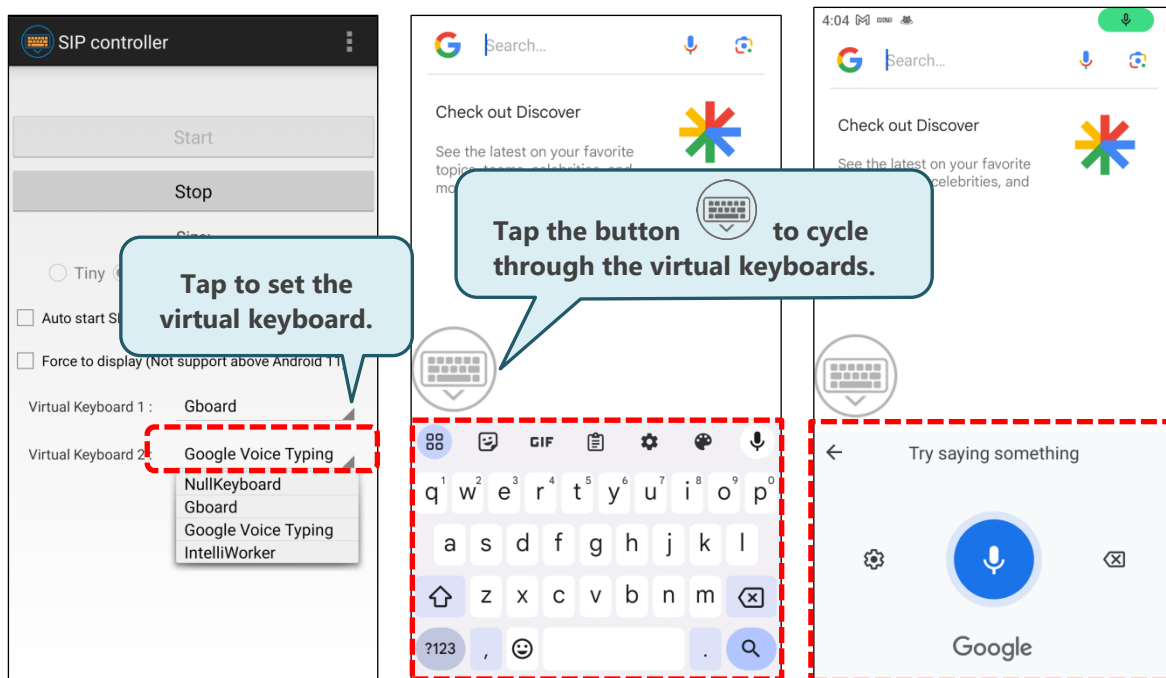

For selecting the keyboard from the drop-down menu, please refer to [On-screen Keyboard](#) for instructions.

EXIT SIP CONTROLLER

Tap on "Stop" to disable **SIP Controller** on-screen button.

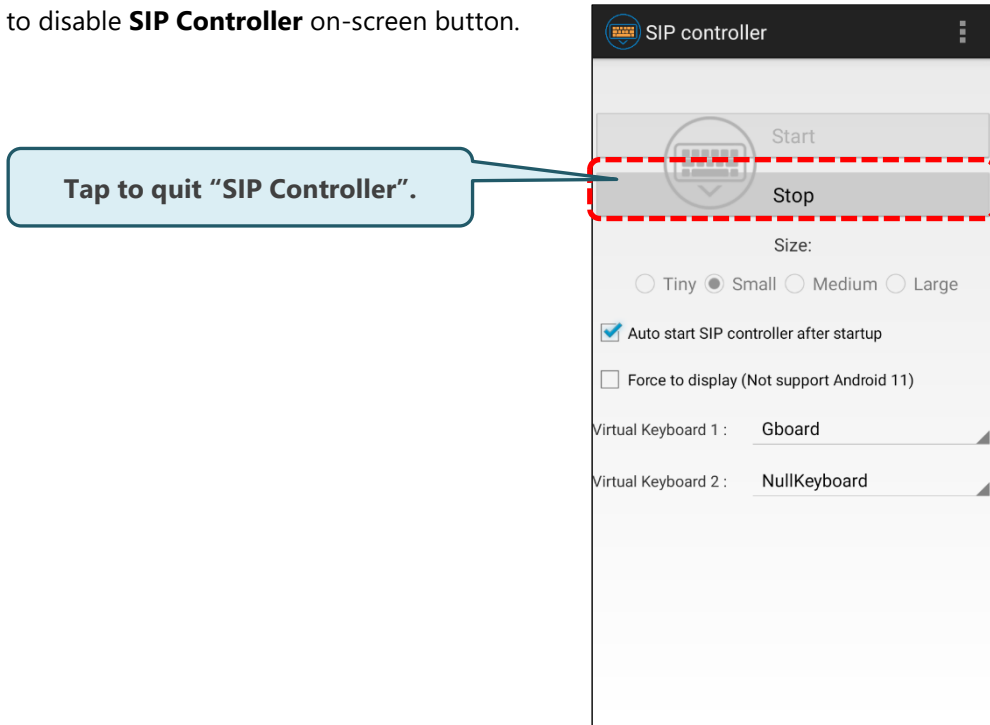

VERSION INFORMATION

Tap on the more button on the action bar and select "About" to check the current version of **SIP Controller**.

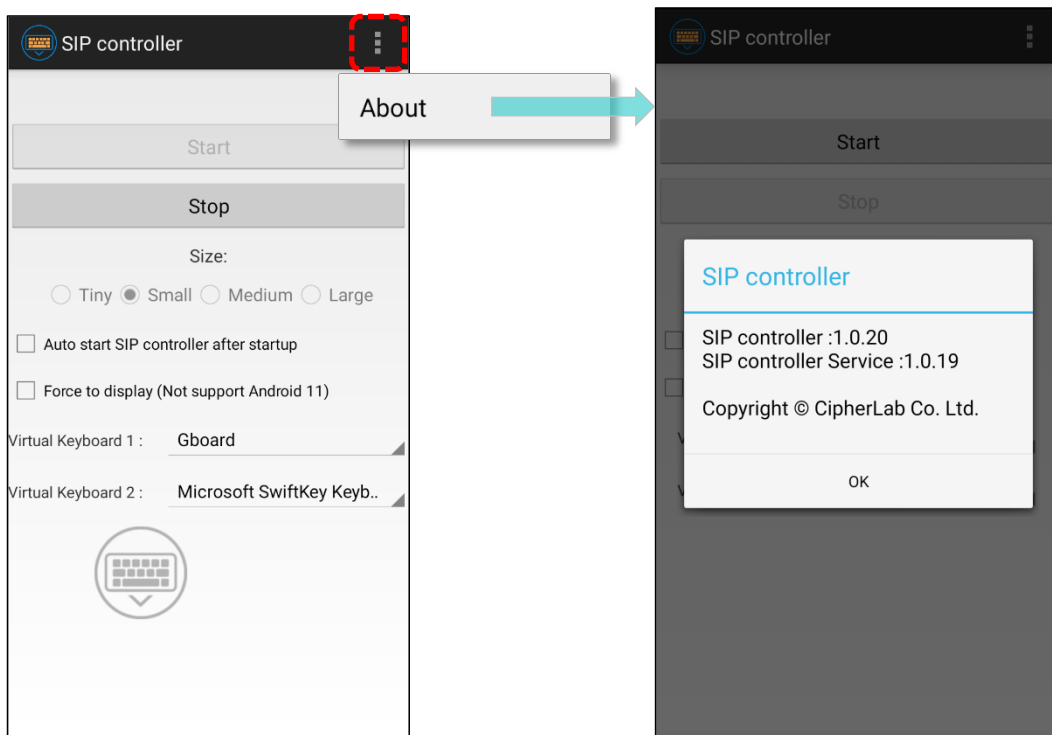

6.11. SOFTWARE TRIGGER



Software Trigger is an application running on a mobile device, functioning as a virtual trigger key. It always floats on top of all other programs, providing convenient control of the barcode scanner. By tapping and holding this virtual button, the device will consistently cast a red beam for scanning codes.

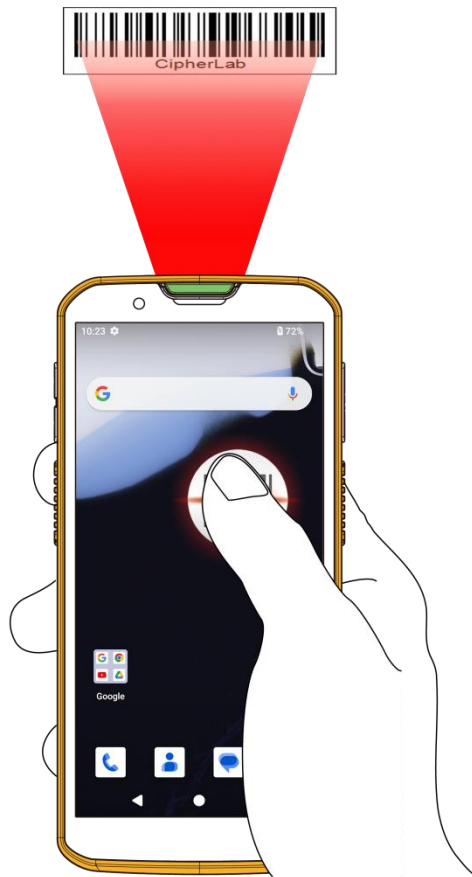

LAUNCH SOFTWARE TRIGGER

Please follow the steps below to launch **Software Trigger**:

- 1) Open the **"Software Trigger"**  app from the App Drawer to access the main screen.
- 2) Select the size of the virtual trigger button.

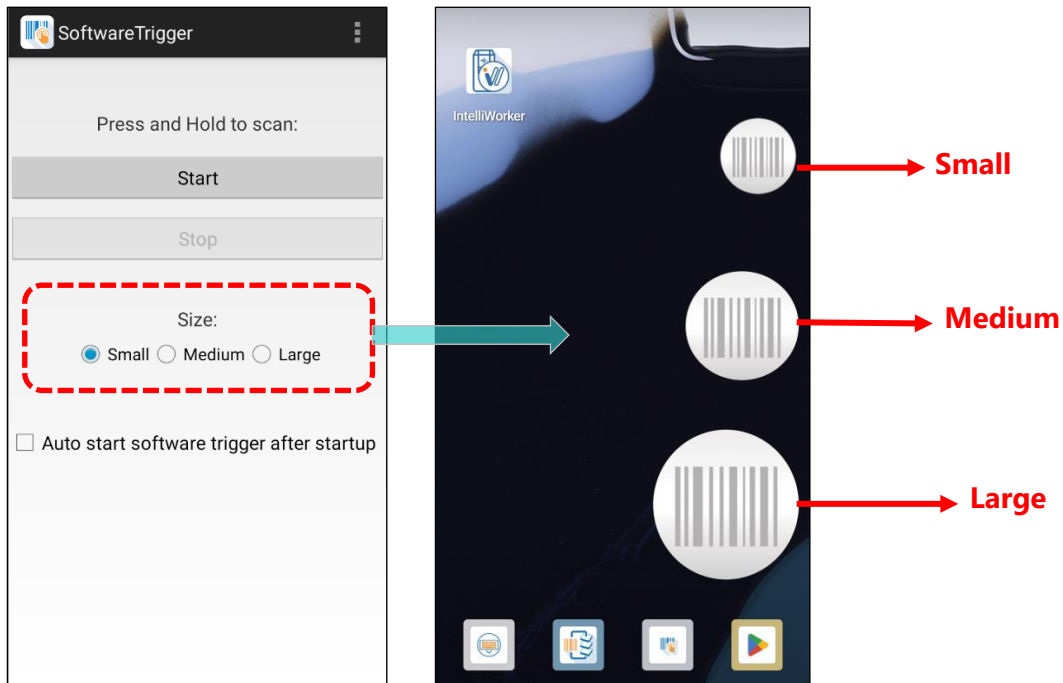

- 3) Tap **"Start"** to enable the button, and check **"Auto start software trigger after startup"** to automatically launch this application after device startup

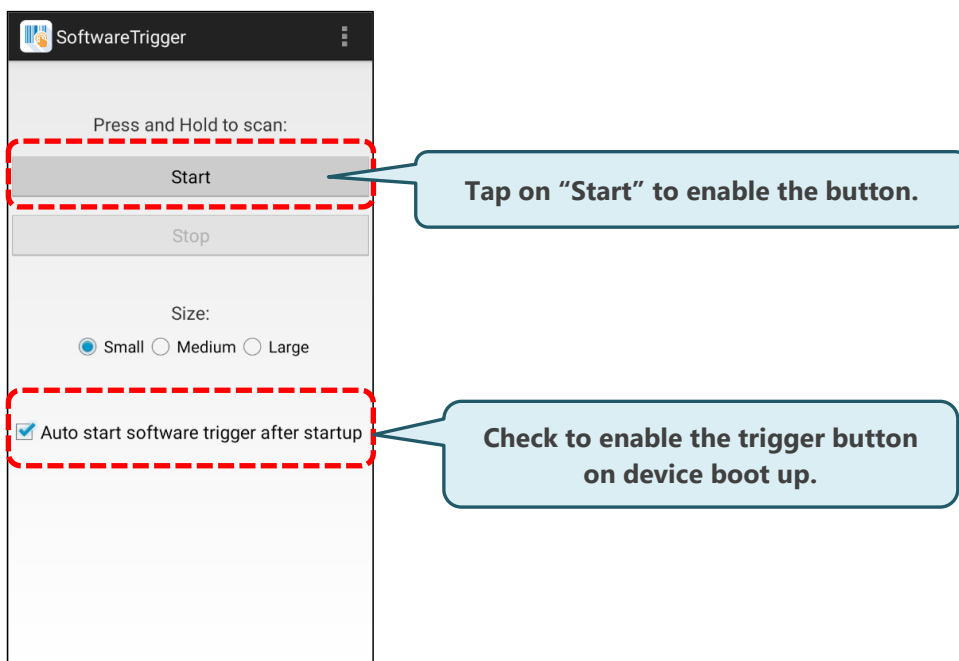

- 4) Always-accessible software keys will appear on your screen. Drag the trigger button to a position where you find it easy to control.

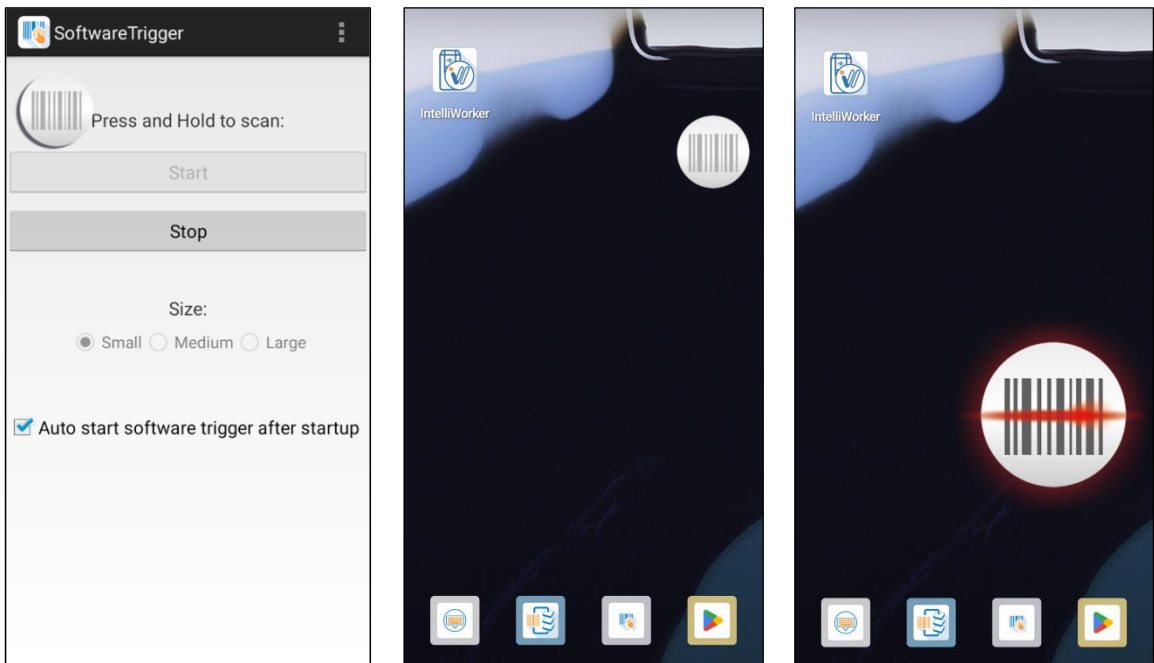

EXIT SOFTWARE TRIGGER

To disable this virtual trigger button, enter **Software Trigger** application screen, and tap **“Stop”**.

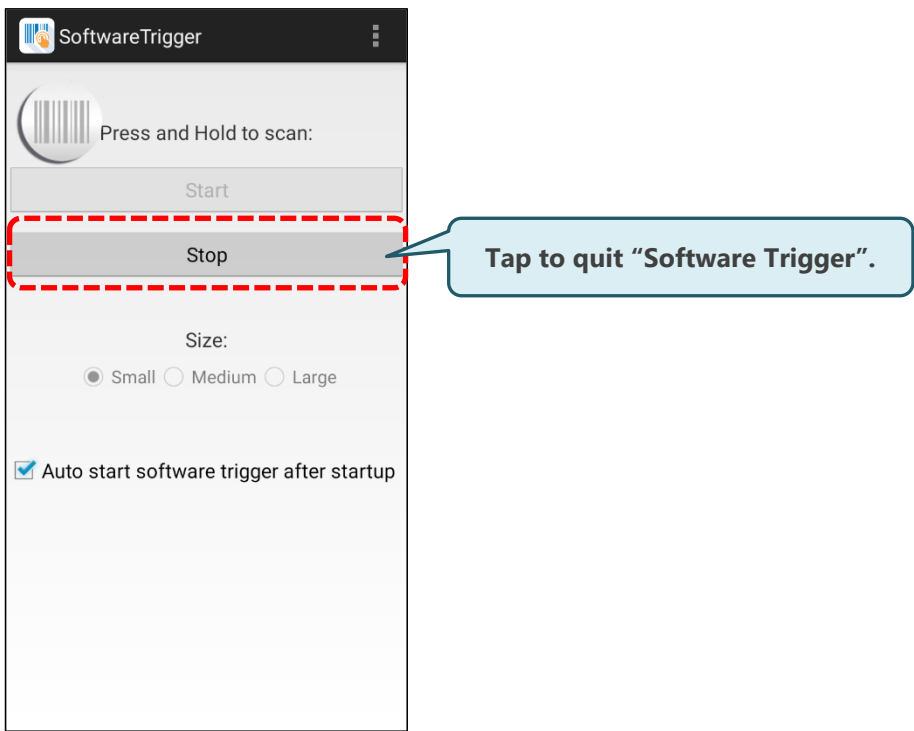

VERSION INFORMATION

To check the current version of **Software Trigger**, please tap on the more button on the action bar and select **"About"**.

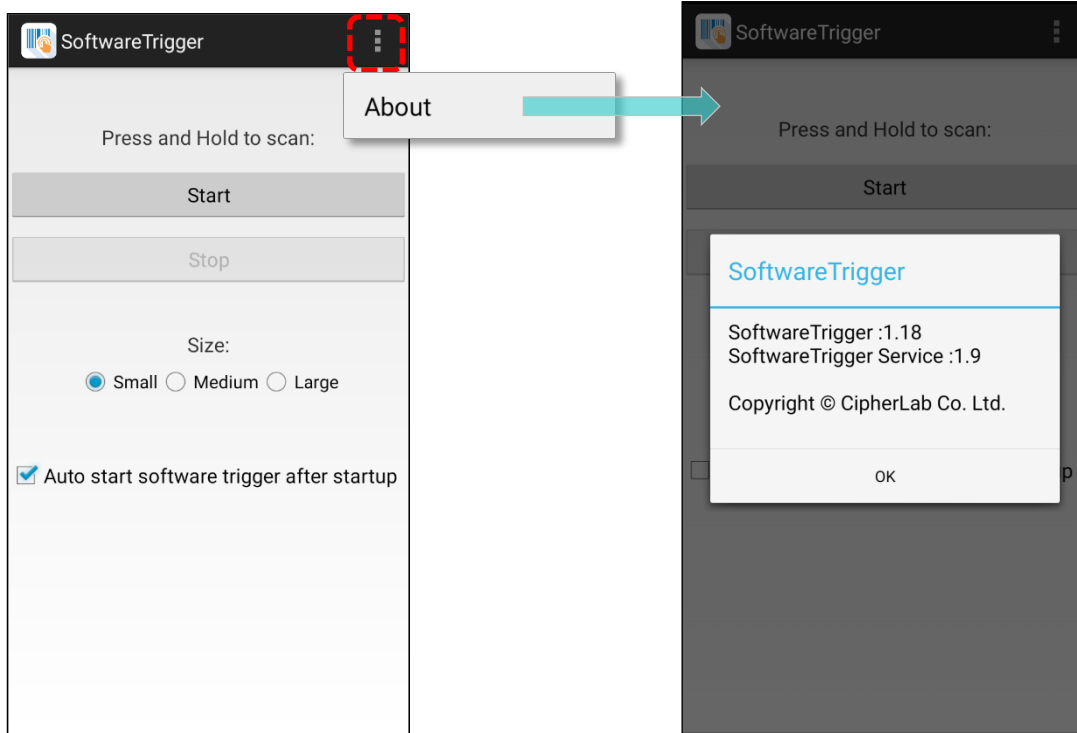

6.12. LOGGEN



LogGen is a host log generator utility specifically designed to assist on-site operators in collecting all event logs (except TE log on Android 11) from mobile computers. With just a tap on one button within this app, logs belonging to the device can be easily generated. IT personnel can then use the history of these events to simulate the real environment and solve problems either locally or remotely.

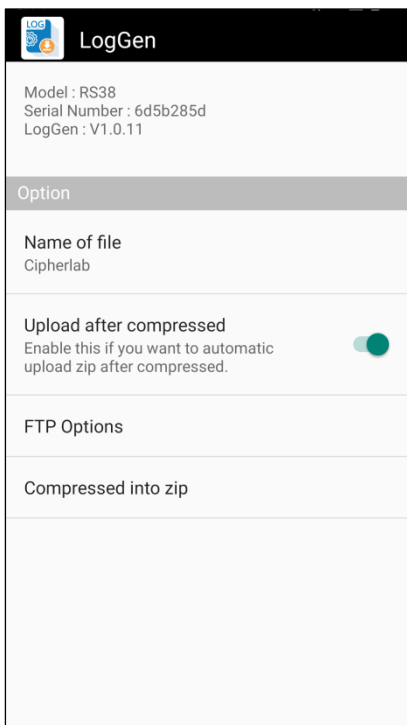

For detailed information, please refer to [LogGen User Guide for Android](#).

6.13. WIRELESS INIT



Wireless Init is a valuable utility designed for on-site operators dealing with unstable networks. This tool allows users to reset and reconnect all wireless connections, including Bluetooth, Wi-Fi, and 4G LTE/5G, with the simple tap of a button.





For detailed information, please refer to [Wireless Init User Guide](#).

6.14. PING



Ping is a versatile network diagnostic utility that includes three valuable tools: **Ping**, **Traceroute**, and **Wi-Fi status**. These tools help diagnose and analyze the current network status efficiently.

LAUNCH PING APPLICATION

- 1) Go to [App Drawer \(All Apps\)](#) and tap on the app "**Ping**"  to enter the ping screen.
- 2) Access the **Option Menu** by either tapping the menu button  or swiping from the leftmost side of the screen to the right.

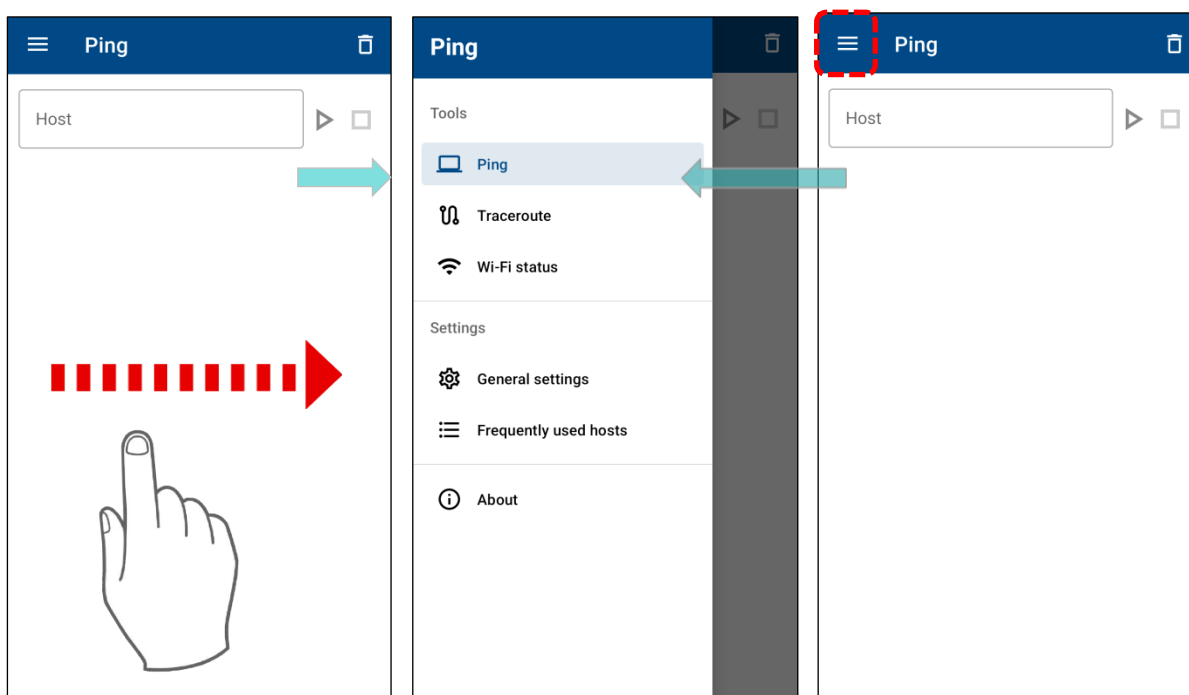

| Tool | Description |
|--------------|--|
| Ping | To determine if a specific host is still active, enter its IP address, domain name, or hostname of the remote host |
| Traceroute | To trace the route of packets to a specific host, enter the IP address, domain name, or hostname of the remote host. |
| Wi-Fi Status | To check the current status of the Wi-Fi connection. |

GENERAL SETTINGS FOR TOOLS

To configure tool-related settings, tap “**General Setting**” on the **Option Menu**. The following setting page will be displayed. To reset all settings of this application, tap the Reset icon .

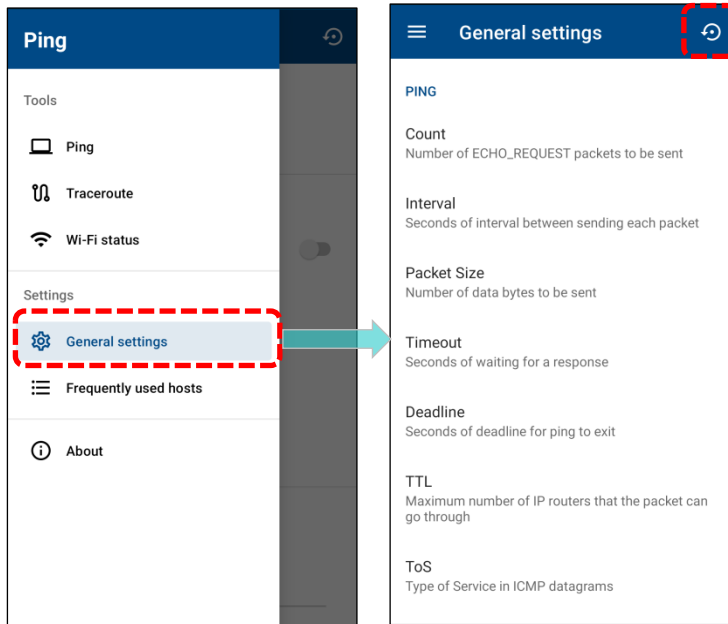

| Settings | Description |
|------------------------|--|
| Ping | |
| Count | Specify the total amount of packets that will be sent to the destination host. |
| Interval | Specify the waiting time before sending the next packet to the destination host. |
| Packet Size | Specify the number of data bytes to be sent. Default packet size is 56 bytes. |
| Timeout | Specify the waiting time for the host response. |
| Deadline | Specify the execution time of sending request to the remote host. |
| TTL | Specify the maximum number of routers that the packet can go through. |
| ToS (Type of service) | Increase the quality of service for the packet to be sent. |
| MTU Discovery strategy | <p>Since the default MTU(Maximum Transmission Unit) of Ethernet is 1500 bytes, the packet will break into fragments if the data size is larger than 1500 bytes. You may optionally change MTU discovery strategy for some purpose. Three MTU Discovery strategies we provide are as follows:</p> <ul style="list-style-type: none"> -Prohibit fragmentation, even local one -Do PMTU discovery, fragment locally when packet size is large |

| | |
|----------------------------|--|
| | -Do not set DF flag |
| Traceroute | |
| Disable IP address mapping | By disabling the function of IP address mapping, Traceroute tool will only show IP address during tracking route without converting IP address into the host name. |
| NQueries | Specify the number of probe packets to be sent per hop. By default, Traceroute tool will send 3 probe packets per hop. |
| Wait Time | Set up the waiting time of the response to one probe for the traceroute. Default waiting time is 5 seconds. |
| Max TTL | Specify the amount of TTL for the traceroute. Default is 30 (max.). |
| Wi-Fi Status | |
| Refresh Rate | Specify the updating refresh rate. Default is 3 seconds. |

VERSION INFORMATION

To check the current version of Ping, please tap **About** on **Option Menu** .

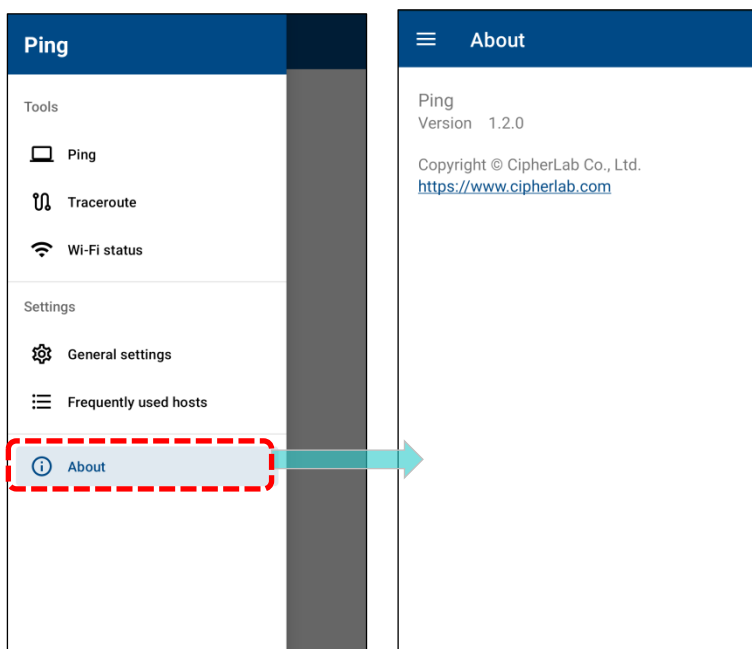

6.15. DISPLAYLINK



DisplayLink is an application that allows the RS38 mobile computer to mirror the screen to a laptop, PC, or any other compatible display device, providing a larger display area for your work.

Before mirroring your screen, ensure the RS38 cradle is powered and the HDMI cable is securely connected to your device.

To **mirror** your screen, follow the steps below:

- 1) Insert the RS38 mobile computer into the cradle's main charging station. A pop-up window will appear with permission requests and warnings. Tap "**OK**". The screen will mirror in about 5 seconds.

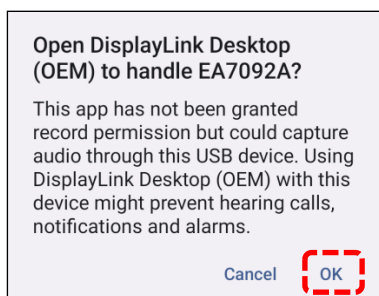

- 2) If the screen does not mirror, go to **Settings|About phone** to [enable Developer Options](#). (see [Section 2.2.1](#).)
- 3) Go to **System| Developer options** and scroll down to the bottom page to ensure that "**Force activities to be resizable**," "**Enable freeform windows**," and "**Force desktop mode**" are toggled off.
- 4) Reinsert the RS38 mobile computer into the cradle's main charging station.

SPECIFICATIONS

PHYSICAL CHARACTERISTICS

Dimensions & Weight

| | |
|------------|--|
| Dimensions | 165.5 mm(L) x 78.5 mm(W) x 15 mm(T) |
| Weight | 268 g \pm 1.5% with standard battery |

Color Touch Screen Display

| | |
|--------------------|---|
| Display | <p>6.0 inch Full High Definition (1080 X 2160)</p> <p>GFF ,Outdoor viewable, optically bonded to Touch Panel</p> <p>Corning® Gorilla® Victus</p> <ol style="list-style-type: none"> 1. Two-mode (sensitivity manually adjustment) 2. Touch with passive stylus (5.5mm min) 3. More than 5 points multi-touch <p>CTP waterproof support:</p> <p>Coating Anti-Finger</p> |
| Display Brightness | 630 cd/m ² typical with CTP (High brightness version LCM) |
| Resolution | 1080 X 2160 Pixel |
| Key | <ol style="list-style-type: none"> 1. Right and Left trigger keys 2. Volume up and volume down keys 3. Power key 4. Function key (User definition) |

Notifications

| | |
|-------------------------|--|
| Status LED and Vibrator | <p>LED 1: Bi-color LED (Green, Red) for power indication.</p> <p>LED 2: Tri-color LED (Blue, Green, Red) for Reader and system notifications</p> <p>Vibrator</p> |
|-------------------------|--|

| | |
|-------|---|
| Audio | <ol style="list-style-type: none"> 1. Built-in Dual Speakers 2. Built-in Receiver 3. Bluetooth headset support, Hands-Free Profile (HFP) 1.6 specification with Wideband speech. 4. USB type-C audio adapter. (Support analog & digital type earphone.) 5. AMR-WB HD-voice support (MODEM default support) |
|-------|---|

PLATFORM, PROCESSOR & MEMORY

Operating System & CPU

| | |
|------------|-------------------------------|
| OS Version | Android 13 with GMS Certified |
| CPU | Qualcomm QCM4490 933pin |

Memory

| | |
|----------------|--|
| ROM | 128GB UFS 3.1 discrete memory |
| RAM | 8GB LPDDR5 |
| Expansion Slot | MicroSD card slot x1 -SDHC supported (up to 32GB) -SDXC supported (up to 1TB) Nano SIM x 1 + eSIM x 1, support 3G/4G/5G |

COMMUNICATION & DATA CAPTURE

Communication

| | |
|------------|--|
| USB Client | Type-C interface: USB 3.1 super speed GEN1 & fast charge |
| WPAN | Bluetooth [®] 5.2 ,EDR/2.1, BLE/V4 .2 (2402~2480 MHz: 7.16dBm) |

| | |
|------|---|
| WLAN | IEEE 802.11 a/b/g/n/ac/ax/d/h/i/r/k/v/w/mc, support fast roaming Support DBS(Dual Band Simultaneous), WiFi 6e with WiFi MIMO2x2 (802.11 ax for Wi-Fi 6 model only) (2412~2472 MHz: 18.33dBm 5180~5240MHz: 19.46dBm, 5260~5320MHz: 20.35dBm, 5500~5700MHz: 20.92dBm, 5745~5825MHz: 20.06dBm) |
| WWAN | GSM:850/900/1800/1900 WCDMA: B1(2100), B2(1900),B4,B5(850),B6,B8(850), LTE:B1/B2/B3/B4/B5/B7/B8/B12/B13/B14/B17/B18/B19/B20/B25/B26/B28/B29/ B30/B38/B39/B40/B41/B42/B43/B48/B66/B71/B41 5G-NR FR1: n1/n2/n3/n5/n7/n8/n12/n13/n14/n20/n25/n26/n28/n29/n30/n34/n38/n39/n40 /n41/n48/n66/n71/n77/n78/n79 Support private networking (LTE/5G) |
| GPS | Dualband(L1+L5)GNSS/GLONASS/Galileo/Beidou/QZSS shall be supported—concurrent L1/G1/E1/B1 (GPS/QZSS, GLO, GAL, BeiDou) + L5/E5a/BDSB2a (GPS/QZSS, GAL, BeiDou) ; a-GPS; supports XTRA |

Data & Image Capture

| | | | |
|----------------|---|-------------|---------------------------------|
| Digital Camera | Rear 16MP x1 (PDAF Auto Focus) with LED flash (support Torch mode) Individually separate the Flash LED FPC & Camera sensor module Front camera 8MP x1 (Fix Focus) | | |
| Barcode Reader | <table border="1"> <tr> <td>▶ 2D imager</td> <td>▶ Zebra SE4770 / SE4100/ SE5500</td> </tr> </table> | ▶ 2D imager | ▶ Zebra SE4770 / SE4100/ SE5500 |
| ▶ 2D imager | ▶ Zebra SE4770 / SE4100/ SE5500 | | |
| NFC | Full tags support base on NFC forum, ISO14443A&B, FeliCa, ISO15693 Support Apple VAS certified | | |

ELECTRICAL CHARACTERISTICS

Battery

| | |
|------------------|--|
| Main Battery | <p>Rechargeable Li-polymer battery: 3.87V, 4500mAh</p> <p>Charging ambient temperature: 0°C~40°C</p> <p>Battery cell charging temperature: 0°C~50°C</p> <p>Minimum charging time: 3.5 hours @25°C (2A@5V)</p> <p>Built-in gas gauge IC for overcharge/over-discharge/overcurrent/short circuit protection</p> <p>Support battery hot swap (0°C~50°C)</p> <p>Over Temperature Protection: -1±3°C / 50±3°C</p> |
| Extended Battery | <p>Rechargeable Li-polymer battery : 3.87V, 6800mAh</p> <p>Charging temperature : 0°C~40°C</p> <p>Battery cell charging temperature: 0°C~50°C</p> <p>Minimum charging time : 4.5 hours @25°C (2A@5V)</p> <p>Built-in gas gauge IC for overcharge/over-discharge/overcurrent/short circuit protection</p> <p>Support battery hot swap (0°C~50°C)</p> |
| Backup Battery | <p>Rechargeable Li-Polymer battery: 90mAh</p> <p>Charging time: 4 hours (when continuously charged, except when powered off).</p> <p>Supports RTC for at least 72 hours when the main battery is removed.</p> <p>Over Temperature Protection: 0±3°C / 65±3°C</p> |

Power Adapter

| | | |
|--|--------|---|
| Power Supply Cord with Universal Power Adapter | Input | AC 100~240V, 50/60 Hz |
| | Output | DC 5V, 2A BSMI, CCC, FCC, CE, CB, RCM, PSE, KC, CU,BIS,INMETRO(AC plug only) |

Certification

| | |
|------------|--|
| 5G | CTA(CCC, SRRC, MII), RoHS, FAC, CU, NCC, CE, WEEE,FCC, IC, NCC, TBL, JRL, BIS, WPC, , REACH, CA65, TSCA, BC, NrCAN, NBTC |
| Wi-Fi Only | SRRC, CCC, BSMI, NCC, CE, FCC, IC, WEEE, RoHS, REACH, CA65, TSCA, BC, NrCAN |

Working Time

| | | |
|--|-----------------|----------------|
| At 25°C, support working time (2D imager) | 4500mAh battery | Up to 14 hours |
| | 6800mAh battery | Up to 21 hours |

ENVIRONMENTAL CHARACTERISTICS**Temperature**

| | |
|-----------------------|---------------------------------|
| Operating Temperature | -20°C to 50°C |
| Storage Temperature | -30°C to 70°C (without battery) |
| Charging Temperature | 0°C to 40°C |

Humidity

| | |
|--------------------|-----------------------------|
| Operating Humidity | 10% to 90% (non-condensing) |
| Storage Humidity | 5% to 95% (non-condensing) |

Resistance

| | |
|---------------------|---|
| Impact Resistance | Multiple 1.8 m drops to concrete over room temperature with protective boot per MIL-STD 810H Multiple 1.5 m drops to tile over concrete per MIL-STD 810H |
| Tumble Test | Per IEC 60068-II-31 Without rubber boot: 500 tumbles at 0.5 m. With rubber boot: 500 tumbles at 1 m. |
| Dust and Waterproof | IP65 and IP68 with battery per IEC 60529. Submerged under water, 1 m deep, for 60 minutes. |

| | |
|-------------------------------|--|
| Electrostatic Discharge (ESD) | Per IEC 61000-4-2, ±15 kV air discharge; ±8 kV direct contact discharge |
|-------------------------------|--|













PROGRAMMING SUPPORT

















Development Environment & Tools





| | |
|------|---|
| JAVA | Environment Android Studio Software Development Kit: JAR |
| C# | Environment: Visual Studio Software Development Kit: DLL (Xamarin Library) |

APPENDIX I

APPLICATION MENU

| Icon | Name | Description |
|---|-----------------------|---|
|  | A-Demo | This application provides a brief introduction to CipherLab's various applications. Users can launch these apps by tapping "START" on the app's introduction page. |
|  | AppLock | An application designed to restrict the system resources available to users |
|  | BarcodeToSetting | This application is used for reading the setting barcodes generated by ADC (Android Deployment Configurator) to apply the configuration. |
|  | BT Printer Mate | An application which provides user interface to pair with Bluetooth printers. |
|  | Button Assignment | The application "Button Assignment" can redefine the functions of physical keys so that they trigger different actions. Settings made to one or more keys can be saved as a profile, allowing users to switch conveniently in between different sets of settings. |
|  | Enterprise Settings | An application offers various functional settings tailored to the project model. |
|  | HF RFID Configuration | An application for the configuration of RFID & NFC. |
|  | Reader Config | Sets scanner preferences, data output format and destination, symbology settings, and reads barcodes. |
|  | Signature Capture | A simple and easy application which transforms your device into a signature pad. |
|  | SIP Controller | An application for quickly open or close virtual keyboard by tapping on the floating button. |
|  | Software Trigger | An application serving as a real trigger key, floating on top of all other programs for convenient trigger control of the barcode scanner. |
|  | Ping | A network diagnostic application which contains the useful tools for analyzing the current network status. |
|  | Settings | Opens settings to configure the mobile computer. |

| Icon | Name | Description |
|---|-----------------|---|
|  | Google | Find quick answers, explore your interests, and stay up to date with Discover. |
|  | Gmail | Connect, create, and collaborate with Gmail, part of Google Workspace. |
|  | Chrome | Chrome is a fast, secure browser built by Google that helps you search, browse, and get things done online. |
|  | Google TV | Google TV brings together movies, shows, live TV and more from across apps and subscriptions and organizes them just for the user. And helps the user discover new things to watch with recommendations based on their interests. |
|  | Google Play | A global online store to find, enjoy, and share your favorite apps, games, and more on all your favorite devices. |
|  | Maps | Explore, navigate, and get things done in your world with Google Maps. |
|  | Google Photos | Google Photos is the home for all your photos, automatically organized and easy to find so you can share and save what matters |
|  | Google Meet | Google Meet provides secure, easy-to-use video meetings that work for everyone so that you can connect and collaborate on what matters most. |
|  | Google Drive | Store, access, and share securely with Google Drive, part of Google Workspace. |
|  | Google Calendar | Get the official Google Calendar app, part of Google Workspace, for your Android phone, tablet, or Wear OS device to save time and make the most of every day. |
|  | Contacts | Back up and sync your contacts across all your devices. Keep your contacts organized and up to date. |
|  | Phone by Google | Phone helps you easily connect with family and friends, block spam callers, and know who's calling before you answer – all with a simple, intuitive design. |
|  | Google Messages | Google Messages is the official Google app for messaging over Rich Communication Services (RCS) with fallback to SMS/MMS. |
|  | Files | Browse and manage your files in local storage and the storage card. |
|  | Calculator | Calculator provides simple and advanced mathematical functions in a beautifully designed app. |
|  | Clock | Sets date, time, time zone according to your locale, and sets and manages alarms. |

| Icon | Name | Description |
|---|---------------|--|
|  | Camera | Take photos and record videos to capture the moments. |
|  | Recorder | Recorder brings the power of search to audio recording. |
|  | YouTube | Enjoy your favorite videos and channels with the official YouTube app. |
|  | YouTube Music | The world of music dedicated to you. |

APPENDIX II

OPEN SOURCE LICENSE

The Reader Config involves the android-serialport-api project of Apache License Version 2.0, January 2004.

<http://www.apache.org/licenses/>

TERMS AND CONDITIONS FOR USE, REPRODUCTION, AND DISTRIBUTION

1. Definitions.

"License" shall mean the terms and conditions for use, reproduction, and distribution as defined by Sections 1 through 9 of this document.

"Licensor" shall mean the copyright owner or entity authorized by the copyright owner that is granting the License.

"Legal Entity" shall mean the union of the acting entity and all other entities that control, are controlled by, or are under common control with that entity. For the purposes of this definition, "control" means (i) the power, direct or indirect, to cause the direction or management of such entity, whether by contract or otherwise, or (ii) ownership of fifty percent (50%) or more of the outstanding shares, or (iii) beneficial ownership of such entity.

"You" (or "Your") shall mean an individual or Legal Entity exercising permissions granted by this License.

"Source" form shall mean the preferred form for making modifications, including but not limited to software source code, documentation source, and configuration files.

"Object" form shall mean any form resulting from mechanical transformation or translation of a Source form, including but not limited to compiled object code, generated documentation, and conversions to other media types.

"Work" shall mean the work of authorship, whether in Source or Object form, made available under the License, as indicated by a copyright notice that is included in or attached to the work (an example is provided in the Appendix below).

"Derivative Works" shall mean any work, whether in Source or Object form, that is based on (or derived from) the Work and for which the editorial revisions, annotations, elaborations, or other modifications represent, as a whole, an original work of authorship. For the purposes of this License, Derivative Works shall not include works that remain separable from, or merely link (or bind by name) to the interfaces of, the Work and Derivative Works thereof.

"Contribution" shall mean any work of authorship, including the original version of the Work and any modifications or additions to that Work or Derivative Works thereof, that is intentionally submitted to Licensor for inclusion in the Work by the copyright owner or by an individual or Legal Entity authorized to submit on behalf of the copyright owner. For the purposes of this definition, "submitted" means any form of electronic, verbal, or written communication sent to the Licensor or its representatives, including but not limited to communication on electronic mailing lists, source code control systems, and issue tracking systems that are managed by, or on behalf of, the Licensor for the purpose of discussing and improving the Work, but excluding communication that is conspicuously marked or otherwise designated in writing by the copyright owner as "Not a Contribution."

"Contributor" shall mean Licensor and any individual or Legal Entity on behalf of whom a Contribution has been received by Licensor and subsequently incorporated within the Work.

2. **Grant of Copyright License.** Subject to the terms and conditions of this License, each Contributor hereby grants to You a perpetual, worldwide, non-exclusive, no-charge, royalty-free, irrevocable copyright license to reproduce, prepare Derivative Works of, publicly display, publicly perform, sublicense, and distribute the Work and such Derivative Works in Source or Object form.

3. **Grant of Patent License.** Subject to the terms and conditions of this License, each Contributor hereby grants to You a perpetual, worldwide, non-exclusive, no-charge, royalty-free, irrevocable (except as stated in this section) patent license to make, have made, use, offer to sell, sell, import, and otherwise transfer the Work, where such license applies only to those patent claims licensable by such Contributor that are necessarily infringed by their Contribution(s) alone or by combination of their Contribution(s) with the Work to which such Contribution(s) was submitted. If You institute patent litigation against any entity (including a cross-claim or counterclaim in a lawsuit) alleging that the Work or a Contribution incorporated within the Work constitutes direct or contributory patent infringement, then any patent licenses granted to You under this License for that Work shall terminate as of the date such litigation is filed.

4. **Redistribution.** You may reproduce and distribute copies of the Work or Derivative Works thereof in any medium, with or without modifications, and in Source or Object form, provided that You meet the following conditions:
 - a. You must give any other recipients of the Work or Derivative Works a copy of this License; and

- b. You must cause any modified files to carry prominent notices stating that You changed the files; and
- c. You must retain, in the Source form of any Derivative Works that You distribute, all copyright, patent, trademark, and attribution notices from the Source form of the Work, excluding those notices that do not pertain to any part of the Derivative Works; and
- d. If the Work includes a "NOTICE" text file as part of its distribution, then any Derivative Works that You distribute must include a readable copy of the attribution notices contained within such NOTICE file, excluding those notices that do not pertain to any part of the Derivative Works, in at least one of the following places: within a NOTICE text file distributed as part of the Derivative Works; within the Source form or documentation, if provided along with the Derivative Works; or, within a display generated by the Derivative Works, if and wherever such third-party notices normally appear. The contents of the NOTICE file are for informational purposes only and do not modify the License. You may add Your own attribution notices within Derivative Works that You distribute, alongside or as an addendum to the NOTICE text from the Work, provided that such additional attribution notices cannot be construed as modifying the License.

You may add Your own copyright statement to Your modifications and may provide additional or different license terms and conditions for use, reproduction, or distribution of Your modifications, or for any such Derivative Works as a whole, provided Your use, reproduction, and distribution of the Work otherwise complies with the conditions stated in this License.

- 5. **Submission of Contributions.** Unless You explicitly state otherwise, any Contribution intentionally submitted for inclusion in the Work by You to the Licensor shall be under the terms and conditions of this License, without any additional terms or conditions. Notwithstanding the above, nothing herein shall supersede or modify the terms of any separate license agreement you may have executed with Licensor regarding such Contributions.
- 6. **Trademarks.** This License does not grant permission to use the trade names, trademarks, service marks, or product names of the Licensor, except as required for reasonable and customary use in describing the origin of the Work and reproducing the content of the NOTICE file.

-
7. Disclaimer of Warranty. Unless required by applicable law or agreed to in writing, Licensor provides the Work (and each Contributor provides its Contributions) on an "AS IS" BASIS, WITHOUT WARRANTIES OR CONDITIONS OF ANY KIND, either express or implied, including, without limitation, any warranties or conditions of TITLE, NON-INFRINGEMENT, MERCHANTABILITY, or FITNESS FOR A PARTICULAR PURPOSE. You are solely responsible for determining the appropriateness of using or redistributing the Work and assume any risks associated with Your exercise of permissions under this License.

 8. Limitation of Liability. In no event and under no legal theory, whether in tort (including negligence), contract, or otherwise, unless required by applicable law (such as deliberate and grossly negligent acts) or agreed to in writing, shall any Contributor be liable to You for damages, including any direct, indirect, special, incidental, or consequential damages of any character arising as a result of this License or out of the use or inability to use the Work (including but not limited to damages for loss of goodwill, work stoppage, computer failure or malfunction, or any and all other commercial damages or losses), even if such Contributor has been advised of the possibility of such damages.

 9. Accepting Warranty or Additional Liability. While redistributing the Work or Derivative Works thereof, You may choose to offer, and charge a fee for, acceptance of support, warranty, indemnity, or other liability obligations and/or rights consistent with this License. However, in accepting such obligations, You may act only on Your own behalf and on Your sole responsibility, not on behalf of any other Contributor, and only if You agree to indemnify, defend, and hold each Contributor harmless for any liability incurred by, or claims asserted against, such Contributor by reason of your accepting any such warranty or additional liability.

END OF TERMS AND CONDITIONS